

• Table of Contents

• How to Use This Catalog

• Product Index

| A - Co

| Cu - I

| J - R

| S - Z



R3 RELIABLE REDISTRIBUTION RESOURCE®



T O T A L S O L U T I O N P R O V I D E R

PRODUCT CATALOG

We've taken a legacy of experience and expertise in redistribution and unified it into one forward thinking organization that delivers the best/most efficient solutions for the redistribution marketplace.

JANITORIAL &
SANITARY SUPPLIES
FOOD SERVICE
PRODUCTS

1 - 8 6 6 - 9 8 7 - R 3 R 3 (7 3 7 3)

FREE UP CASH AND GET NEW GROWTH WITH REDISTRIBUTION

PLUS ORDER ONLY WHAT YOU NEED ONLINE. ANYWHERE.
ONE SOURCE. ONE CONTACT.

Why tie up your capital in inventory and its management, when you can order from us only what you need, when you need it? You'll enjoy faster inventory turnaround times, reduce warehousing, freight and order processing costs.

We'll take care of the logistics and transportation for increased supply chain efficiency. The bottom line is we help you reduce the cost of possession and increase your ROI.



R3 RELIABLE REDISTRIBUTION RESOURCE®

Your Best Source for Food Service, Jan-San, and Green Product Needs.

visit us at www.r3redistribution.com

Table of Contents

GREEN7-34 GS



**BOWLS, PLATES &
PLATTERS221-230 FS**



CHEMICALS35-84 JS



CUPS231-246 FS



SOAPS85-104 JS



**RESTAURANT & BAR
SUPPLIES247-264 FS**



**HARD FLOOR
CARE105-114 JS**



**NAPKINS, PLACEMATS &
TABLECOVERS .265-270 FS**



CARPET CARE . .115-118 JS



**CONTAINERS
& TRAYS271-306 FS**



**PAPER
PRODUCTS119-146 JS**



BAGS307-318 FS



APPAREL147-156 JS



**FS PROCESSING, WRAPS &
APPAREL319-336 FS**



**CLEANING
TOOLS157-192 JS**



INDEXES337-356 I



**CAN LINERS &
CONTAINERS . . .193-214 JS**



**FLOOR
EQUIPMENT . . .215-220 JS**



NOTE: Not all products in this catalog may be in stock at our location, but with our logistics network all of them are readily available. Additionally, there are items offered by our sources of supply that are not included in this catalog. They are considered Special Order Items. If you have questions concerning a product not listed in this catalog please contact your Sales Representative. Special Order Items require a longer lead-time than regularly stocked product. Once ordered, Special Order Items are non-cancelable and cannot be returned to us. Lastly, we are not responsible for any errors or omissions in this catalog.

© 2011 R3 Reliable Redistribution Resource, LLC Elk Grove Village, IL 60007

Content is Copyrighted & Published by © 2011 Summit Catalog Company Centennial, CO 80112

Practical production methods make it impossible to illustrate in this catalog every product that we carry. However, the products shown are generally the most representative of the manufacturer's line and/or those in most common usage by the trade. For information about unlisted, additional or new products, please telephone us.

Not responsible for errors, omissions or typographical errors.



GREEN SOURCE™
Be Green - Save Green

R3® is rolling out its Green Source™ towel, tissue and napkin products.

Our house keeps getting greener!

R3®

Your source for **green-certified towel, tissue and napkin products without the additional cost.**

- 100% Recycled
- Chlorine-Free
- Trilingual Packaging (English, Spanish & French)



Certified Hand Towels CCD-086
and Toilet Tissue CCD-082



For more information about these Green Source™ products, go to www.r3redistribution.com/green/green-source.asp

R3 REDUCE REUSE RECYCLE



WWW.R3REDISTRIBUTION.COM

HIDDEN COST SAVING OPPORTUNITY



Don't let
inventory costs
put the "freeze"
on your growth.

R3 can help reduce the "iceberg" of acquisition costs that freezes up capital. Why tie up your capital in inventory and its management, when you can order from us only what you need, when you need it? You'll enjoy faster inventory turnaround times, freeing up warehouse space and reducing costly wastage.

We'll take care of the logistics and transportation for you, for increased supply chain efficiency. The bottom line is we help you reduce the cost of possession, to help improve your company's bottom line.

DEPENDABLE. FLEXIBLE. FOCUSED.

www.r3redistribution.com



R3 RELIABLE REDISTRIBUTION RESOURCE®



R3 RELIABLE REDISTRIBUTION RESOURCE®

The only redistribution organization
with national - even international -
presence and reach.

Tableware



TABLEWARE

A. COMPOSTABLE TABLEWARE BRIDGE-GATE ALLIANCE GROUP

Premium dinnerware made from renewable resources. Compostable. FDA approved for food use. Grease and water-resistant. Microwaveable. BPI certified.

B7280008	<i>BGW12B</i>	12 oz., Bowl	8/125/cs.
B7280012	<i>BGW06</i>	6" dia., Plate	8/125/cs.
B7280013	<i>BGW07</i>	7" dia., Plate	8/125/cs.
B7280011	<i>BGW09</i>	9" dia., Plate	4/125/cs.
B7280009	<i>BGW103</i>	10 ¹ / ₄ " dia., 3-Compt. Plate	4/125/cs.
B7280010	<i>BGW10</i>	10 ¹ / ₂ " dia., Plate	4/125/cs.
B7280016	<i>BGW710</i>	7" x 10", Platter	4/125/cs.
B7280015	<i>BGW912</i>	9" x 12", Platter	4/125/cs.



B. HARVEST COLLECTION™ TABLEWARE GENPAK

Compostable dinnerware item for foodservice applications. Produced from environmentally friendly, annually renewable resources.

34789245	<i>HCD12</i>	12 oz., Bowl	1000/cs.
34789244	<i>HCB24</i>	24 oz., Bowl	200/cs.
34789243	<i>HCB32</i>	32 oz., Bowl	200/cs.
34789241	<i>HCD06</i>	6" dia., Plate	1000/cs.
34789240	<i>HCD09</i>	9" dia., Plate	200/cs.
34789239	<i>HCD39</i>	9" dia., 3-Compt. Plate	250/cs.
34789238	<i>HCD10</i>	10 ¹ / ₄ " dia., Plate	250/cs.
34789237	<i>HCD13</i>	10 ¹ / ₄ " dia., 3-Compt. Plate	250/cs.



C. CHINET® CLASSIC WHITE™ MOLDED FIBER TABLEWARE HUHTAMAKI

Chinet® Classic White™ premium strength paper tableware is recognized everywhere as a quality product you can rely on for superior strength. Made of 99% reclaimed fiber and is microwaveable. 100% recycled/compostable.

15304628	<i>22506</i>	4 oz., Bowl, Burgundy & Gray	2000/cs.
15304644	<i>22507</i>	12 oz., Bowl, Burgundy & Gray	1000/cs.
15304658	<i>22607</i>	12 oz., Bowl, Festival Design	1000/cs.
15304603	<i>22501</i>	6" dia., Plate, Burgundy & Gray, Pocket	1000/cs.
15306315	<i>21225</i>	6" dia., Plate, White, Vacate	1000/cs.
15304637	<i>22508</i>	6 ³ / ₄ " dia., Plate, Burgundy & Gray, Pole	1000/cs.
15304610	<i>22502</i>	8 ³ / ₄ " dia., Plate, Burgundy & Gray, Point	500/cs.
15304640	<i>22509</i>	9 ³ / ₄ " dia., Plate, Burgundy & Gray, Poodle	500/cs.
15304670	<i>22505</i>	10 ¹ / ₂ " dia., Plate, Burgundy & Gray, Poplar	500/cs.
15304632	<i>22605</i>	10 ¹ / ₂ " dia., Plate, Festival Design, Porch	500/cs.
15304690	<i>22504</i>	7 ¹ / ₂ " x 10", Plate, Burgundy & Gray, Pony	500/cs.



D. NATURE FRIENDLY® PLA SALAD BOWLS NATURE FRIENDLY PRODUCTS

Nature Friendly Products' compostable PLA containers and trays provide consumers with an eco-friendly alternative to traditional disposables. Made from corn-based PLA renewable resources, they are completely compostable within 50-100 days in commercial composting facilities. Superior in strength and performance, non-toxic, and clear in color.

C6938050	<i>SB120300</i>	10 oz.	1000/cs.
C6938051	<i>SB141500</i>	18 oz.	1000/cs.
C6938052	<i>SB1781000</i>	36 oz.	500/cs.
C6938056	<i>L12025</i>	Dome Lid Fits 10 oz.	1000/cs.
C6938057	<i>L14128</i>	Dome Lid Fits 18 oz.	1000/cs.
C6938058	<i>L17832</i>	Dome Lid Fits 36 oz.	500/cs.



GREEN



Tableware



A. NATURE FRIENDLY® COMPOSTABLE TABLEWARE NATURE FRIENDLY PRODUCTS

100% biodegradable and compostable tableware provides consumers with an eco-friendly alternative to traditional disposables. Made from sugar cane bagasse-based renewable resources, they are completely compostable within 50-100 days in home and commercial composting facilities. These products are superior in strength and performance. Non-toxic, hot/cold tolerant, oil and water resistant, microwave and freezer safe.

C6932002	<i>L003</i>	12 oz., Classic Bowl	500/cs.
C6932003	<i>L003R</i>	12 oz., Classic Bowl, Retail Pack	500/cs.
C6932038	<i>L044</i>	13½ oz., Classic Bowl	1000/cs.
C6932039	<i>L044R</i>	13½ oz., Classic Bowl, Retail Pack	24/25/cs.
C6932022	<i>L027</i>	14 oz., Barreled Bowl	600/cs.
C6932021	<i>L026B</i>	12 oz., Soup/Salad Bowl	500/cs.
C6932001	<i>L001B</i>	16 oz., Soup/Salad Bowl	500/cs.
C6932014	<i>L014B</i>	32 oz., Soup/Salad Bowl	500/cs.
C6931000	<i>P001</i>	6" dia., Ridged Edge Round Plate	1000/cs.
C6931010	<i>P011</i>	7" dia., Plate	1000/cs.
C6931011	<i>P011R</i>	7" dia., Plate, Retail Pack	1000/cs.
C6931001	<i>P002</i>	7" dia., Ridged Edge Round Plate	1000/cs.
C6931002	<i>P003</i>	8" dia., Ridged Edge Round Plate	1000/cs.
C6931012	<i>P013</i>	9" dia., Plate	500/cs.
C6931013	<i>P013R</i>	9" dia., Plate, Retail Pack	500/cs.
C6931008	<i>P009</i>	9" dia. (7" x 5" Center), Oval Plate	1000/cs.
C6931003	<i>P005</i>	10" dia., Plate	500/cs.
C6931004	<i>P005R</i>	10" dia., Plate, Retail Pack	500/cs.
C6931005	<i>P007</i>	10" dia., 3-Compt. Plate	500/cs.
C6931006	<i>P007R</i>	10" dia., 3-Compt. Plate, Retail Pack	500/cs.
C6931020	<i>P020</i>	10" dia., Oval Plate	500/cs.
C6931030	<i>P030</i>	12½" dia., Oval Plate	500/cs.
C6932020	<i>L026A</i>	Lid Fits 12 oz. Bowl	500/cs.
C6932023	<i>L028</i>	Lid Fits 14 oz. Barreled Soup	600/cs.
C6932000	<i>L001A</i>	Lid Fits 16 oz. Bowl	500/cs.
C6932013	<i>L014A</i>	Lid Fits 32 oz. Bowl	500/cs.

B. PLACESSETTER® PREFERRED™ MOLDED FIBER TABLEWARE PACTIV

Pactiv Placesetter® Preferred™ molded fiber products are compostable and meet the ASTM D 6868 standards specifications for compostability. These products are made from sustainable, annually renewable materials that are environmentally friendly. Product is made of a blend of bagasse (sugar cane) and bamboo which are sustainable, annually renewable resources. Soak through resistant design resists grease, moisture and helps eliminate messy leaks. Natural white provides a brilliant, white exterior. Stackable.

16206900	<i>MC50008</i>	8 oz., Bowl	1000/cs.
16206887	<i>MC50012</i>	12 oz., Bowl	1000/cs.
16206884	<i>MC50016</i>	16 oz., Bowl	500/cs.
16206879	<i>MC50006</i>	6" dia., Plate	1000/cs.
16206899	<i>MC5000700001</i>	6¾" dia., Plate, (Sleeved)	1000/cs.
16206895	<i>MC50009001</i>	8¾" dia., Plate, (Sleeved)	500/cs.
16206881	<i>MC50010</i>	10" dia., Plate	500/cs.
16201577	<i>YMC500110001</i>	8¾" dia., 3-Compt. Plate	500/cs.
16206896	<i>MC50044001</i>	10" dia., 3-Compt. Plate	500/cs.
16206888	<i>MC50043</i>	7½" x 10" x 1", Platter	500/cs.
16206898	<i>MC500470001</i>	9⅞" x 12½" x 1", Platter	500/cs.

C. PLACESSETTER® SELECT HEAVY-DUTY TABLEWARE PACTIV

Coated for extra strength as well as grease and moisture resistance. This durable, heavyweight tableware is oil and moisture-resistant. Placesetter® Select plates are also cut-resistant and work well for any occasion. Plates are safe for use in microwave ovens. Bright white plates are suitable for all foodservice and foodservice management applications.

16202516	<i>PSP0515PUNPC</i>	12 oz., Bowl	1000/cs.
16202515	<i>PSP0605PUNPCF</i>	6" dia., Fluted Plate	1000/cs.
16202514	<i>PSP0705PUNPC</i>	7" dia., Plate	1000/cs.
16202513	<i>PSP0905PUNPC</i>	8¾" dia., Plate	500/cs.
16202512	<i>PSP1005PUNPC</i>	10¼" dia., Plate	500/cs.

Tableware/Cutlery



A. BIODEGRADABLE DINNERWARE TRELLIS EARTH

100% biodegradable. Non-toxic. Microwaveable and steamer-safe.

C4780053	<i>WFW09</i>	20 oz., Soup Bowl	300/cs.
C4780052	<i>WFW10</i>	Lid Fits 20 oz. Soup Bowl	300/cs.
C4780046	<i>WFW07</i>	16 oz., Rectangle Bowl	300/cs.
C4780051	<i>WFW08</i>	Lid Fits Rectangle Bowl 16 oz.	300/cs.
C4780048	<i>WFD31</i>	10 1/4" dia., Deep Meal Plate	200/cs.
C4780047	<i>WFD32</i>	Plate Cover Fits WFD-31	200/cs.

DISPOSABLE CUTLERY

B. NATURE FRIENDLY® CUTLERY NATURE FRIENDLY PRODUCTS

Made from a proprietary compostable resin. Completely compostable within 50-100 days in properly managed composting facilities. Superior strength, quality performance. High temperature resistant up to 190°F. Impermeable and non-toxic.

C6935009	<i>CHW302</i>	Spoon (Bulk), 1000 pc.	1000/cs.
C6935007	<i>CHW102</i>	Fork (Bulk), 1000 pc.	1000/cs.
C6935008	<i>CHW202</i>	Knife (Bulk), 1000 pc.	1000/cs.
C6935003	<i>CHW300</i>	Spoon (Bulk), 2000 pc.	20/100/cs.
C6935001	<i>CHW100</i>	Fork (Bulk), 2000 pc.	20/100/cs.
C6935002	<i>CHW200</i>	Knife (Bulk), 2000 pc.	20/100/cs.
C6935006	<i>CHW301</i>	Spoon (Individually Wrapped), 500 pc.	5/100/cs.
C6935004	<i>CHW101</i>	Fork (Individually Wrapped), 500 pc.	5/100/cs.
C6935005	<i>CHW201</i>	Knife (Individually Wrapped), 500 pc.	5/100/cs.
C6935050	<i>CHW1200</i>	Cutlery Combo Kit (4 Boxes), 300 pc.	1200/cs.

C. BIOPLASTIC CUTLERY TRELLIS EARTH

Made from corn polymers, starches and complementary ingredients to create a blend that is 100% biodegradable and microwave or freezer safe.

Bulk Packed

C4780055	<i>WFS11</i>	Tasting Spoon, 1000 ct.	1000/cs.
C4780063	<i>CTS03</i>	Tasting Spork, 500 ct.	2500/cs.
C4780024	<i>WFS08</i>	Soup Spoon, 100 ct.	1000/cs.
C4780006	<i>WFS06</i>	Spoon, 100 ct.	1000/cs.
C4780023	<i>WFS09</i>	Spork, 100 ct.	1000/cs.
C4780005	<i>WFS05</i>	Fork, 100 ct.	1000/cs.
C4780007	<i>WFS07</i>	Knife, 100 ct.	1000/cs.

Individually Bagged

Bagged in a Trellis Earth™ biodegradable bioplastic bag for a complete environmentally responsible package.

C4780045	<i>WFS10</i>	Soup Spoon, 1000 ct.	1000/cs.
C4780054	<i>WFS13</i>	Spork, 1000 ct.	1000/cs.
C4780033	<i>WFS03</i>	Spoon, 1000 ct.	3000/cs.
C4780002	<i>WFS02</i>	Fork, 1000 ct.	1000/cs.
C4780004	<i>WFS04</i>	Knife, 1000 ct.	1000/cs.

Premium Bagged

Bagged in conventional plastic, heat-sealed bags for optimal sanitation. We took our cutlery and made it stronger, heavier, and more rigid. Works to 248°F. Textured handle.

C4780081	<i>WFS36</i>	Spoon, Beige, 100 ct.	1000/cs.
C4780080	<i>WFS35</i>	Fork, Beige, 100 ct.	1000/cs.
C4780082	<i>WFS37</i>	Knife, Beige, 100 ct.	1000/cs.

Retail Packed

C4780094	<i>WFS58</i>	Soup Spoon, White, 100 ct.	600/cs.
C4780069	<i>WFS68</i>	Soup Spoon, White, 500 ct.	3000/cs.
C4780092	<i>WFS53</i>	Spoon, White, 100 ct.	600/cs.
C4780071	<i>WFS66</i>	Spoon, White, 500 ct.	3000/cs.
C4780076	<i>WFS74</i>	Fork, White, 60 ct.	
C4780091	<i>WFS52</i>	Fork, White, 100 ct.	600/cs.
C4780072	<i>WFS65</i>	Fork, White, 500 ct.	3000/cs.
C4780093	<i>WFS54</i>	Knife, White, 100 ct.	600/cs.
C4780070	<i>WFS67</i>	Knife, White, 500 ct.	3000/cs.



GREEN

Cutlery/Cold Cups



A. BIOPLASTIC CUTLERY SETS TRELLIS EARTH

Cover all the bases with these three-piece cutlery sets of bioplastic forks, knives, and spoons. Your customers will be pleasantly surprised when they see their takeout order packed with our eco-friendly cutlery. Trellis Earth™ bioplastic cutlery is made from corn polymers, starches and complementary ingredients to create a blend that is 100% biodegradable and microwave or freezer safe. Just as effective as conventional plastic cutlery.

C4780074	<i>WFS71</i>	60 ct., 20 Each (Spoon, Fork, Knife)	1200/cs.
C4780090	<i>WFS51</i>	150 ct., 50 Each (Spoon, Fork, Knife)	900/cs.
C4780075	<i>WFS72</i>	150 ct., 50 Each (Spoon, Fork, Knife)	2400/cs.
C4780073	<i>WFS61</i>	450 ct., 200 Fork, 150 Spoon, 100 Knife	2700/cs.
C4780018	<i>WFS01</i>	250 Sets, Bagged, Basic	1000/cs.
C4780064	<i>WFS31</i>	250 Sets, Bagged, Premium	1000/cs.

B. STATESMAN COMPOSTABLE CUTLERY WNA COMET

Our compostable line of products is an ecologically sound and practical choice. Earthsense™ offers superior performance and appearance vs. other "green" disposable products. Meets ASTM D6400 for biopolymers. Also compost using Cedar Grove's stringent test methods. Heavyweight.

12200149	<i>CGFB420605</i>	Spoon, Brown	600/cs.
12200150	<i>CGFB410605</i>	Fork, Brown	600/cs.
12200148	<i>CGFB430605</i>	Knife, Brown	600/cs.

C. MALIBU COMPOSTABLE CUTLERY WNA COMET

Mediumweight disposable cutlery. Meets ASTM D6400 for biopolymers. Also compost using Cedar Grove's stringent test methods.

12200194	<i>CGFB120165</i>	Spoon, Brown	600/cs.
12200195	<i>CGFB120265</i>	Fork, Brown	600/cs.
12200189	<i>CGFB120365</i>	Knife, Brown	600/cs.

COLD & HOT CUPS

D. HARVEST COLLECTION™ COLD DRINK CUP GENPAK

Compostable dinnerware item for foodservice applications. Produced from environmentally friendly, annually renewable resources.

34789234	<i>HCC16</i>	16 oz., Harvest Tan	1000/cs.
-----------------	--------------	---------------------	----------

E. NATURE FRIENDLY® PLA COLD CUPS NATURE FRIENDLY PRODUCTS

Nature Friendly Products' compostable PLA cold cups provide consumers with an eco-friendly alternative to traditional disposables. Made from sugar cane bagasse-based renewable resources, they are completely compostable within 50-100 days in home and commercial composting facilities. Superior in strength and performance. Non-toxic, hot/cold tolerant, oil and water resistant, microwave and freezer safe.

C6938003	<i>PLA98540</i>	16 oz.	1000/cs.
C6930003	<i>GC16SR</i>	16/18 oz., Retail Pack	1000/cs.
C6938004	<i>PLA98650</i>	22 oz.	1000/cs.
C6938012	<i>L988K</i>	Flat Lid Fits 16/22 oz. Cups	1000/cs.

F. BARE™ RECYCLED COLD CUPS SOLO®

Bare™ cups are made from 25% post-consumer recycled plastic, helping reduce new materials being created from earth's resources. Our cups can be recycled in most communities that accept plastic water bottles, further enriching the stream of recycled materials that can be used to make more Bare™ cups as well as lots of other things, such as carpets, laundry scoops, shoelaces, and much more. Strong and clear, Bare™ cups display the same quality our consumers have come to expect from Solo's conventional clear cups. Bare™ by Solo®: Bringing Alternative Resources for the Environment.

18201013	<i>RTP16J9036</i>	16 oz., Bloom	1000/cs.
18201001	<i>RTN20J9036</i>	20 oz., Bloom	1000/cs.
18200998	<i>RTD24J9036</i>	24 oz., Bloom	600/cs.

Cold & Hot Cups/Straws



A. EARTHCHOICE™ PLA CUPS & LIDS PACTIV

Made from a natural plastic material called Ingeo™, an ingenious new material made from plants instead of oil. This means that Ingeo™ is 100% annually renewable and EarthChoice™ cups and lids are fully compostable in municipal and industrial facilities. Exceptional clarity makes drink identification easy and presents contents in an upscale way. Large coding system allows easy size recognition in dispensers when pulling from inventory. Exceptional strength and durability, made tough for everyday demand. Custom printing available to communicate brand image. Optimized cube utilization packs provide efficient shipping.

16202475	<i>YPLA9C</i>	9 oz., Clear	975/cs.
16202474	<i>YPLA1412C</i>	12-14 oz., Clear	680/cs.
16202473	<i>YPLA160C</i>	16 oz., Clear	696/cs.
16202472	<i>YPLA21C</i>	20 oz., Clear	600/cs.
16202469	<i>YPLA24C</i>	24 oz., Clear	580/cs.
16202476	<i>YLPADL24C</i>	Dome Lid Fits 12, 14, 16, 20, 24 oz.	900/cs.
16202042	<i>YLPLA24C</i>	Straw Slot Lid Fits 12, 14, 16, 20, 24 oz.	915/cs.



B. ECOTAINER™ HOT CUPS & LIDS INTERNATIONAL PAPER

Sourced from fully renewable resources, these cups use a corn-based plastic instead of a petrochemical as a moisture barrier. This new PLA-based coating also makes the cup compostable in municipal and commercial composting facilities. Combined with a smaller manufacturing energy requirement, the ecotainer™ packaging reduces our environmental impact while providing all the functionality of a standard cup. Your customers won't be able to tell a difference, but the environment will. Contains NatureWorks® PLA.

14700080	<i>SMRE8</i>	8 oz.	1000/cs.
14703034	<i>SMME10</i>	10 oz.	1000/cs.
14700350	<i>SMRE12</i>	12 oz.	1000/cs.
14700351	<i>SMRE16</i>	16 oz.	1000/cs.
14700349	<i>SMRE20</i>	20 oz.	1000/cs.
14700227	<i>LHRDS8</i>	Lid Fits 8 oz.	1000/cs.
14700300	<i>LHRDS16</i>	Lid Fits 12, 16, 20, 24 oz.	1200/cs.



C. BARE™ RECYCLED HOT CUPS SOLO®

First ever FDA compliant PCF paper hot cup. Made from at least 10% post-consumer recycled fiber. Made from at least 90% renewable resources.

18200989	<i>374RCJ8484</i>	4 oz.	1000/cs.
18200991	<i>378RCJ8484</i>	8 oz.	1000/cs.
18200993	<i>410RCJ8484</i>	10 oz. Squat	1000/cs.
18200992	<i>370RCJ8484</i>	10 oz.	1000/cs.
18200994	<i>412RCJ8484</i>	12 oz.	1000/cs.
18200995	<i>316RCJ8484</i>	16 oz.	1000/cs.
18200997	<i>420RCJ8484</i>	20 oz.	600/cs.



D. CUP BUDDY® SLEEVE INTERNATIONAL PAPER

Fits 12, 16 and 20 oz. cups. Designed for high insulation, this cup buddy sleeve comes in a neutral color to complement your cup design.

14704002	<i>RCDK20</i>	Brown	1200/cs.
-----------------	---------------	-------	----------



STRAWS/NAPKINS/TABLECOVER

E. NATURE FRIENDLY® STRAWS NATURE FRIENDLY PRODUCTS

Nature Friendly Products' compostable tableware provides consumers with an eco-friendly alternative to traditional disposables. Made from sugar cane bagasse-based renewable resources, they are completely compostable within 50-100 days in home and commercial composting facilities. Superior in strength and performance. Non-toxic, hot/cold tolerant, oil and water resistant, microwave and freezer safe.

C6935078	<i>ST775N4500W</i>	7 1/4", Giant, Wrapped	2000/cs.
C6935077	<i>ST1025G12300W</i>	10 1/4", Jumbo, Wrapped	1200/cs.



GREEN



Napkins



A. HI-VALU NAPKINS PRIME SOURCE®

High quality napkins are value priced. Ideal for all public environments. White.

Dispenser Napkins			
73002654	73002654	11 1/5" x 7", Low Fold, 1-Ply	10000/cs.
Dinner Napkins			
73004390	73004390	15" x 17", 1/8 Fold, 2-Ply	3000/cs.
73004391	73004391	15" x 17", 1/8 Fold, 2-Ply, Embossed	3000/cs.
73004392	73004392	15" x 17", 1/8 Straight, 2-Ply, Embossed	3000/cs.
73004393	73004393	15" x 17", 1/8 Fold, Side-by-Side, 2-Ply	3000/cs.
73004394	73004394	17" x 17", 1/8 Straight, 2-Ply, Embossed	3000/cs.

B. TORK® WHITE ADVANCED NAPKINS SCA TISSUE

Beverage Napkins - 2-Ply
Two-ply and facial grade provides a superior look and feel to other beverage napkins. Box packaging ensures perfect product quality and protection. Disposal is simple and convenient. Made from 100% recycled fiber. Environmental Choice EcoLogo™ Certified. White.

14101241	B1241	300 ct., 10" x 10", 5" x 5" Folded, 1/4 Fold	3000/cs.
-----------------	-------	--	----------

Dinner Napkins

The embossed facial quality napkin brings class and practicality to casual dining. Ideal for high volume applications. NP5240C replaces NP5240 and NP5240A. NP7340A replaces NP7340 and NP7380. Made from 100% recycled fiber, it offers environmental benefits and is a positive image builder. Environmental Choice EcoLogo™ Certified.

2-Ply			
14102000	NP310A	375 ct., 15" x 16 1/4", 3 3/4" x 8 1/8" Folded, 1/8 Fold	3000/cs.
14105241	NP5240C	375 ct., 15" x 16 1/4", 7 1/2" x 8 1/8" Folded, 1/4 Fold	3000/cs.
3-Ply			
14102001	NP7380A	290 ct., 17" x 16 1/8", 4 1/4" x 8" Folded, 1/8 Fold	1740/cs.
14107340	NP7340A	250 ct., 17" x 16 1/8", 8 1/2" x 8 1/8" Folded, 1/4 Fold	2000/cs.

C. TORK® DISPENSER NAPKINS SCA TISSUE

Tork® Advanced Dispenser Napkins - 1-Ply
Facial quality enhances feel and absorbency. Largest open and folded size dispenser napkin making it a good value, fewer napkins needed per serving. Bag packaging ensures superior product quality while protecting unused napkins. Made from 100% recycled fiber. Environmental Choice EcoLogo™ Certified.

14100826	D826E	Minifold, 500 ct., 13" x 12" Open, 6 1/2" x 3 3/4" Folded, Natural, Green Seal®	6000/cs.
14100820	D820	Luxri 13, 500 ct., 13" x 12" Open, 6 1/2" x 3 3/4" Folded, White,	6000/cs.
14100806	D806E	Luxri 17, 500 ct., 12" x 17" Open, 5" x 6 1/2" Folded, Natural, Green Seal®	6000/cs.
14101802	D802A	Luxri 17, 500 ct., 12" x 17" Open, 5" x 6 1/2" Folded, White	6000/cs.

Tork® Universal Dispenser Napkins - 1-Ply

Facial quality enhances feel and absorbency. Smaller opened size makes it an economical option. Bag packaging ensures superior product quality while protecting unused napkins. Napkins are made from 100% recycled fiber. Environmental Choice EcoLogo™ Certified.

14106313	D6311A	Thrifty Daintifold, 334 ct., 5 1/2" x 12", 3 1/2" x 5" Folded, White	8016/cs.
14103058	D3056B	Betsy Tallfold, 625 ct., 6" x 13 1/2", 3 1/2" x 6 3/4" Folded, Natural	10000/cs.
14100191	D3052B	Betsy Tallfold, 625 ct., 6" x 13 1/2", 3 1/2" x 6 3/4" Folded, White	10000/cs.
14103060	D3061A	Daintifold Lowfold, 250 ct., 8 7/10" x 12", 3 1/2" x 5" Folded, White	8000/cs.
14100786	D786E	Masterfold, 500 ct., 13" x 12", 5" x 6 1/2" Folded, Natural	6000/cs.
14100780	D780	Masterfold, 500 ct., 13" x 12", 5" x 6 1/2" Folded, White	6000/cs.



GREEN

Napkins/Tablecover/Food Containers



A. DISPENSER NAPKINS SCA TISSUE

Rollnap Dispenser Napkins - 1-Ply

Contains 100% recycled fibers. Environmental Choice EcoLogo™ Certified.

14107049 DR7050 500 ct., 9" x 17", White, 1-Ply 6000/cs.

Xpressnap® 1/4 Fold Dispenser Napkins - 1-Ply

Xpressnap napkins are larger than major competitor interfolded napkins offering strength, absorbency and quality to users. Inner bag packaging. Contains 100% recycled fibers, Environmental Choice EcoLogo™ Certified.

14102900 DX900 500 ct., 8 1/2" x 13", 4 1/4" x 6 1/2" Folded, White 6000/cs.

14100901 DX906E 500 ct., 13" x 8 1/2", 6 1/2" x 4 1/4" Folded, Natural 6000/cs.



B. TORK® WHITE UNIVERSAL NAPKINS SCA TISSUE

Embossed semi-crepe texture. Economical napkin is perfect for high volume applications.

Made from 100% recycled fiber. Environmental Choice EcoLogo™ Certified. White.

Beverage Napkins - 1-Ply

14101141 B1141A 1000 ct., 9 3/8" x 9 3/8", 4 3/4" x 4 3/4" Folded, 1/4 Fold 4000/cs.

Luncheon Napkins - 1-Ply

14103141 L3141 500 ct., 13" x 11 1/2", 5 3/4" x 6 1/2" Folded, 1/4 Fold 6000/cs.

Dinner Napkins - 1-Ply

14102003 N5183A 500 ct., 15" x 16 1/4", 3 3/4" x 8 1/8" Folded, 1/8 Fold 2000/cs.

14102006 N5181A 250 ct., 15" x 17", 3 3/4" x 8 1/2" Folded, 1/8 Fold 3000/cs.

14105140 N5140A 334 ct., 15" x 17", 7 1/2" x 8 1/2" Folded, 1/4 Fold 3000/cs.

14107142 N7141A 334 ct., 17" x 17", 8 1/2" x 8 1/2" Folded, 1/4 Fold 4008/cs.



C. TORK® PREMIUM FOLDED TABLECOVER SCA TISSUE

Sturdy poly backing that protects from spills. Soft three-ply tissue delivers the softness and drape of cloth. Disposable for quick and easy cleanup that helps reduce costs. SCA does not guarantee that this product will contain any recycled fibers.

14100529 540TW 54" x 108", White, 3-Ply, Key Emboss 20/cs.



FOOD CONTAINERS

D. HINGED TAKE OUT CONTAINERS BRIDGE-GATE ALLIANCE GROUP

Hingeware made from renewable resources. Compostable. FDA approved for food use.

Grease and water-resistant. Microwaveable. BPI certified.

Premium

B7280100 BG6HW 6" 500/cs.

B7280101 BG8HW 8" 200/cs.

B7280102 BG83HW 8", 3-Compt. 200/cs.

B7280103 BG9HW 9" 200/cs.

B7280104 BG93HW 9", 3-Compt. 200/cs.

B7280107 BGHOAGIE 19.69" x 11.42" x 10.04", Hoagie 250/cs.

Economy

B7280200 ECO6HW 6" 4/100/cs.

B7280201 ECO8HW 8" 2/100/cs.

B7280202 ECO83HW 8", 3-Compt. 2/100/cs.

B7280203 ECO9HW 9" 2/100/cs.

B7280204 ECO93HW 9", 3-Compt. 2/100/cs.

B7280205 ECOHOAGIE 9" x 5" x 3", Hoagie 2/125/cs.



E. HARVEST COLLECTION™ HINGED CONTAINERS GENPAK

Compostable containers made from environmentally friendly, annually renewable resources.

34789246 HCH80 8" x 8" x 2 1/2", Harvest Tan 200/cs.

34789236 HCH83 8" x 8" x 2 1/2", 3-Compt., Harvest Tan 200/cs.



GREEN



Food Containers

GREEN



A. EXPRESSIONS™ ECO™ TRAYS & CONTAINERS INNOWARE

Created from plants, not petroleum. Meet the ASTM standards for compostability. They biodegrade in a commercial compost facility within 60-180 days without releasing any toxic residues. Approved by Cedar Grove Composting, Inc.

ECO™ Bases & Lids

12600021	0972013	7 1/2" Base, Tan	300/cs.
12604015	0974015	9" Base, Tan	150/cs.
12601016	0976016	10 1/4" Base, 3-Compt., Tan	130/cs.
12603016	0973016	Clear Lid Fits 7 1/2"	300/cs.
12605016	0975016	Clear Lid Fits 9"	150/cs.
12601018	0977018	Clear Lid Fits 10 1/4"	130/cs.
12603014	0973014	Solid Lid Fits 7 1/2", Tan	300/cs.
12605014	0975014	Solid Lid Fits 9", Tan	150/cs.
12607014	0977014	Solid Lid Fits 10 1/4", 3-Compt., Tan	130/cs.

ECO™ Octaview Hinged Container

12604050	0854011	9" x 3", Tan	200/cs.
----------	---------	--------------	---------



B. NATURE FRIENDLY® COMPOSTABLE CONTAINERS NATURE FRIENDLY PRODUCTS

Made from sugar cane bagasse-based renewable resources, they are completely compostable within 50-100 days in home and commercial composting facilities. Non-toxic, hot/cold tolerant, oil and water-resistant, microwave and freezer safe.

Hinged Containers

C6933003	B003	5" x 5", Hamburger	250/cs.
C6933004	B024	5" x 5", Hamburger	250/cs.
C6933011	B1127	6" x 6", Hamburger	500/cs.
C6933001	B001	7 1/2" x 5", Lunch Box	250/cs.
C6933009	B110	8" x 8"	250/cs.
C6933012	B118	8" x 8", 3-Compt.	200/cs.
C6933002	B002	9" x 5 1/2", 2-Partition Box	500/cs.
C6933007	B025	9" x 9"	200/cs.
C6933013	B119	10" x 10"	250/cs.
C6933010	B111	10" x 10", 3-Compt.	250/cs.

Square Bowl & Lid

C6933006	B021	5 1/2" x 5 1/2", Square Bowl	450/cs.
C6933005	B020	Lid Fits 5 1/2" x 5 1/2" Square Bowl	450/cs.



C. ECOTAINE™ HOT FOOD CONTAINERS INTERNATIONAL PAPER

Sourced from fully renewable resources, these cups use a corn-based plastic instead of a petrochemical as a moisture barrier. Compostable in municipal and commercial composting facilities. The ecotainer™ packaging reduces our environmental impact while providing all the functionality of a standard cup. Contains NatureWorks® PLA.

14700332	DFRE8	8 oz.	1000/cs.
14703031	DFRE12COMPASS	12 oz., Compass	1000/cs.
14705016	LTFH16	Vented Lid Fits 6/8/10/16 oz.	500/cs.
14700124	LFRFH12	Vented Lid Fits 12 oz.	1000/cs.

D. NATURE FRIENDLY® PLA CONTAINERS NATURE FRIENDLY PRODUCTS

Made from corn-based PLA renewable resources, they are completely compostable within 50-100 days in commercial composting facilities. Superior in strength and performance, non-toxic, and clear in color.

Round Containers/Lids

C6938030	RC95250	8 oz.	2000/cs.
C6938031	U120500	16 oz.	1000/cs.
C6938032	U1411000	32 oz.	600/cs.
C6938035	L959	Lid Fits 8 oz.	2000/cs.
C6938036	L12016	Lid Fits 16 oz.	1000/cs.
C6938037	L14116	Lid Fits 32 oz.	600/cs.

Portion Cups/Lids

C6938070	AP6260	2 oz.	2500/cs.
C6938071	AP78105	3 1/2 oz.	2500/cs.
C6938072	AP78130	4 1/2 oz.	2500/cs.
C6938075	L628K	Lid Fits 2 oz.	2500/cs.
C6938076	L789K	Lid Fits 3 1/2, 4 1/2 oz.	2500/cs.



Food Containers, Boxes & Trays



A. EARTHCHOICE™ PLA PORTION CUPS & LIDS PACTIV

Made from a natural plastic material called Ingeo™, an ingenious new material made from plants instead of oil. Ingeo™ is 100% annually renewable, and EarthChoice™ cups and lids are fully compostable in municipal and industrial facilities. Exceptional strength durable, made tough for everyday demand. Custom printing available to communicate brand image.

16202561	YSPLA200EC	2 oz.	2400/cs.
16202562	YSPLA300EC	3 1/4 oz.	2400/cs.
16202565	YSPLA400EC	4 oz.	2400/cs.
16202564	YLSPLA2	Lid, Fits 2 oz.	2400/cs.
16202563	YLSPLA3	Lid, Fits 3 1/4 and 4 oz.	2400/cs.



B. SOUFLÉ CUPS & LIDS TRELIS EARTH

Perfect for showing you care about saving the environment across your entire food line.

C4780044	WFR05	2 oz., White	2500/cs.
C4780041	WFR07	4 oz., White	2500/cs.
C4780037	WFR06	Lid Fits 2 oz., White	2500/cs.
C4780039	WFR08	Lid Fits 4 oz., White	2500/cs.



C. EARTHCHOICE™ HINGED LID CONTAINERS PACTIV

Fiber Blend

Fiber blend hinged lid containers meet the ASTM D 6868 standards for compostability. Made of a blend of fiber and pulp materials. Double tab lock keeps container securely closed. All natural white provides a brilliant, white exterior. Stackable. Soak-through resistant design resists grease, moisture and helps eliminate messy leaks.

16200422	MCH0080	6" x 6" x 2 3/10", Sandwich 1-Compt.	500/cs.
16200357	MCH0801	8 1/10" x 8 1/10" x 2 1/10", Medium 1-Compt.	200/cs.
16200355	MCH0803	8 1/10" x 8 1/10" x 2 1/10", Medium 3-Compt.	200/cs.
16200359	MCH0089	9" x 6 1/5" x 3", Utility 1-Compt.	200/cs.
16200353	MCH0901	9 1/5" x 8 3/4" x 2 1/2", Large 1-Compt.	200/cs.
16200352	MCH0903	9 1/5" x 8 3/4" x 2 1/2", Large 3-Compt.	200/cs.

Smartlock®

EarthChoice™ SmartLock® hinged lid containers are made from Talc-Filled Polypropylene which contains on average 40% less plastic polymers than standard polypropylene containers. Microwaveable up to 250°F; ideal for your hot food take-out menu items.

SmartLock® Closure System provides an audible "click" indicating a secure closure.

Textured sidewalls provide secure handling. Stackable.

16201421	CN80600	16 oz., 5 19/20" x 5 3/4" x 3 1/4", Sandwich 1-Compt.	400/cs.
16201413	CN80801	32 oz., 8 3/10" x 8 3/10" x 3 2/5", Medium 1-Compt.	200/cs.
16201405	CN80901	42 oz., 8 17/20" x 9 3/10" x 3 3/10", Large 1-Compt.	100/cs.
16201411	CN80803	4 4/14 oz., 8 1/10" x 8 3/10" x 3 2/5", Medium 3-Compt.	200/cs.
16201404	CN80903	6 6/18 oz., 8 17/20" x 9 3/10" x 3 3/10", Large 3-Compt.	100/cs.



D. PLA HINGED CONTAINERS REYNOLDS FOOD PACKAGING

Hinged multi sized containers (heat tolerance up to 105°F).

17300095	8656CGC	Small, 6" x 6", Clear	210/cs.
17300096	8657CGC	Medium, 9" x 8", Clear	180/cs.
17300097	8630CGC	Large, 9" x 9 1/2", Clear	100/cs.



FOOD BOXES & TRAYS

E. TRAY BRIDGE-GATE ALLIANCE GROUP

Premium dinnerware made from renewable resources. Compostable. FDA approved for food use. Grease and water-resistant. Microwaveable. BPI certified.

B7280014	BGW108T	10 2/5" x 8 1/2", 5-Compt.	500/cs.
----------	---------	----------------------------	---------



F. BAKERS' CRAFT™ BAKERY LINE CLIMAX MFG

Manufactured from 100% recycled fiber, 30% post-consumer waste.

25234115	BX451623	Cake Box, 6" x 18" x 3", Full Sheet	25/cs.
25234118	BX441622	Cake Box, 9" x 14" x 4", 1/2 Sheet	50/cs.
25234116	BX411615	Cake Box, 10" x 10" x 5"	100/cs.
25234117	BX411616	Cake Box, 14" x 10" x 4", 1/4 Sheet	100/cs.
25234111	BX411611	Pie Box, 8" x 8" x 2 1/2"	100/cs.
25234112	BX493370	Pie Box, 10" x 10" x 2 1/2"	100/cs.
25234114	BX411634	Donut Box, 9" x 4 1/2" x 4", 1/2 Dozen	100/cs.
25234113	BX411636	Donut Box, 10 1/4" x 8" x 4", 1 Dozen	100/cs.



GREEN



Food Trays



A. BIO-PLUS® EARTH FOOD CONTAINERS FOLD-PAK

Made from 100% recycled paper using 35% or more post-consumer recycled paper. Bio-Plus Earth is processed chlorine-free and performs as well as our Bio-Pak product. It reduces the amount of packaging you use because it can hold any type of food from hot, cold, wet, or dry food products. Bio-Plus Earth is endorsed by the Green Restaurant Association and the endorsement logo is printed on the bottom of every container.

26080043	<i>01BPEARTHM</i>	#1, 22 oz., Earth	450/cs.
26088000	<i>08BPEARTHM</i>	#8, 29 oz., Earth	300/cs.
26080067	<i>02BPEARTHM</i>	#2, 36 oz., Earth	200/cs.
26080042	<i>03BPEARTHM</i>	#3, 56 oz., Earth	200/cs.
26088001	<i>04BPEARTHM</i>	#4, 75 oz., Earth	160/cs.



B. CARRYOUT TRAY GEORGIA PACIFIC

Natural chipboard. Made from tan bending chip, a type of recycled sheet.

13403825	<i>20013525</i>	10 ¹ / ₂ " x 10 ¹ / ₂ " x 3 ³ / ₄ "	200/cs.
-----------------	-----------------	---	---------



C. NATURE FRIENDLY® TRAYS NATURE FRIENDLY PRODUCTS

Made from sugar cane bagasse-based renewable resources, they are completely compostable within 50-100 days in home and commercial composting facilities. Non-toxic, hot/cold tolerant, oil and water resistant, microwave and freezer safe.

C6934006	<i>T009</i>	8 ¹ / ₂ " x 10 ¹ / ₂ "	5-Compt.	500/cs.
C6934001	<i>T002</i>	9 ¹ / ₅ " x 6 ³ / ₅ "	1-Compt.	500/cs.

D. PRESSWARE® DUAL-OVENABLE TRAYS PACTIV

Dual-ovenable paperboard trays withstand temperatures up to 400°F for up to 60 minutes. They can be stored in a freezer or refrigerator without cracking or denting. There are two closure options; clear OPS dome lids or peelable film (dome lids are not to be used in microwave or conventional ovens).

Baker's Assurance®			
16200560	<i>PBA7106</i>	23 oz., 7 ¹ / ₄ " x 11 ⁵ / ₁₆ " x 23/32"	500/cs.

Blue Country Classic™ - Blue			
16202614	<i>PBC5613R</i>	14 ¹ / ₂ oz., 4 ²⁷ / ₃₂ " x 6 ¹⁷ / ₃₂ " x 1 ³ / ₈ "	1000/cs.
16202615	<i>PBC5615</i>	16 ³ / ₅ oz., 4 ²⁹ / ₃₂ " x 6 ³ / ₃₂ " x 1 ¹¹ / ₁₆ "	500/cs.
16200236	<i>PBC6816</i>	32 oz., 6" x 7 ⁷ / ₈ " x 1 ³ / ₄ "	500/cs.
16200625	<i>PBC7014</i>	45 oz., 7 ¹⁵ / ₃₂ " x 9 ³¹ / ₃₂ " x 1 ¹ / ₂ "	250/cs.

Classic Stoneware™ - Round - White/Brown Specks			
16200856	<i>PCS0412</i>	5 ⁷ / ₁₀ oz., 4 ³ / ₁₆ " x 1 ¹ / ₄ ", Round	1000/cs.
16200549	<i>CI80412</i>	OPS Dome Lid for PCS0412, Clear	1000/cs.
16202540	<i>PCS0511</i>	7 ³ / ₅ oz., 5 ¹ / ₁₆ " x 1 ¹ / ₈ ", Round	1000/cs.
16201056	<i>PCS01305</i>	38 oz., 13 ³ / ₃₂ " x 19/32"	250/cs.
16201055	<i>PCS01505</i>	52 oz., 15 ⁷ / ₁₆ " x 19/32"	250/cs.

Classic Stoneware™ - Square - White/Brown Specks			
16204403	<i>PCS4403</i>	3 ¹ / ₂ oz., 4 ⁵ / ₁₆ " x 4 ⁵ / ₁₆ " x 3/8"	3000/cs.
16201106	<i>PCS4412</i>	5 ⁴ / ₅ oz., 4 ³ / ₁₆ " x 4 ³ / ₁₆ " x 1 ¹ / ₄ "	1500/cs.
16201053	<i>PCS4413</i>	9 ¹ / ₂ oz., 4 ⁵ / ₈ " x 4 ⁵ / ₈ " x 1 ³ / ₈ "	1000/cs.

Classic Stoneware™ - Oblong - White/Brown Specks			
16202541	<i>PCS4707</i>	9 ⁷ / ₁₀ oz., 4" x 7 ¹ / ₁₆ " x 7/8"	1000/cs.
16201054	<i>PCS0713H</i>	12 ¹ / ₅ oz., 4 ⁷ / ₈ " x 7 ¹ / ₃₂ " x 1 ³ / ₈ "	1000/cs.
16200865	<i>PCS4512</i>	13 oz., 4 ⁷ / ₈ " x 5 ¹⁵ / ₁₆ " x 1 ¹ / ₄ "	1000/cs.
16208501	<i>PCS5611R</i>	13 ⁴ / ₅ oz., 4 ²⁹ / ₃₂ " x 6 ¹⁷ / ₃₂ " x 1 ¹ / ₈ "	1000/cs.
16200646	<i>CI85611R</i>	OPS Dome Lid for PCS5611R, Clear	1000/cs.
16208503	<i>PCS5613RR1</i>	14 ¹ / ₂ oz., 4 ²⁷ / ₃₂ " x 6 ¹⁷ / ₃₂ " x 1 ³ / ₈ "	1000/cs.
16200012	<i>CI85613R</i>	OPS Dome Lid for PCS5613RR1, Clear	1000/cs.
16201119	<i>PCS5613</i>	14 ¹ / ₂ oz., 4 ³¹ / ₃₂ " x 6 ⁹ / ₁₆ " x 1 ³ / ₈ "	1000/cs.
16201118	<i>CI85613</i>	OPS Dome Lid for PCS5613, Clear	1000/cs.
16201123	<i>PCS5710</i>	15 ² / ₅ oz., 5 ¹ / ₁₆ " x 7 ¹³ / ₁₆ " x 1"	500/cs.
16201125	<i>CI85710</i>	OPS Dome Lid for PCS5710, Clear	500/cs.
16208502	<i>PCS5615</i>	16 ⁴ / ₅ oz., 4 ²⁹ / ₃₂ " x 6 ³ / ₃₂ " x 1 ¹¹ / ₁₆ "	500/cs.
16200606	<i>CI85615</i>	OPS Dome Lid for PCS5615, Clear	1000/cs.
16207342	<i>PCS5811R</i>	20 ¹ / ₂ oz., 5 ²⁹ / ₃₂ " x 8 ⁹ / ₃₂ " x 1 ¹ / ₈ "	500/cs.
16205714	<i>PCS5713</i>	20 ¹ / ₅ oz., 5 ¹ / ₁₆ " x 7 ²⁵ / ₃₂ " x 1 ³ / ₈ "	250/cs.
16200848	<i>CI85713</i>	OPS Dome Lid for PCS5713, Clear	250/cs.
16202542	<i>PCS5617</i>	21 oz., 5" x 6 ¹ / ₂ " x 1 ⁷ / ₈ "	500/cs.
16200203	<i>PCS5713R</i>	21 ³ / ₁₀ oz., 5 ⁷ / ₁₆ " x 7 ¹ / ₁₆ " x 1 ³ / ₈ "	500/cs.



GREEN

Food Trays/Reusable Bags



A. PRESSWARE® DUAL-OVENABLE TRAYS (CONT.) PACTIV

Dual-ovenable paperboard trays withstand temperatures up to 400°F for up to 60 minutes. They can be stored in a freezer or refrigerator without cracking or denting. There are two closure options; clear OPS dome lids or peelable film (dome lids are not to be used in microwave or conventional ovens).

Classic Stoneware™ - Oblong - White/Brown Specks (Cont.)

16205712	CI85713R	OPS Dome Lid for PCS5713R, Clear	500/cs.
16207341	PCS6812R	27 ⁹ / ₁₀ oz., 6 ¹ / ₁₆ " x 8 ²⁵ / ₃₂ " x 1 ¹ / ₄ "	500/cs.
16201057	PCS6816	32 oz., 6" x 7 ⁷ / ₈ " x 1 ³ / ₄ "	500/cs.
16208839	CI86816	OPS Dome Lid for PCS6816, Clear	500/cs.
16201645	PCS6815	36 ⁷ / ₁₀ oz., 6 ¹⁹ / ₃₂ " x 8 ³ / ₄ " x 1 ⁵ / ₈ "	250/cs.
16204646	PCS7014	45 oz., 7 ¹⁵ / ₃₂ " x 9 ³¹ / ₃₂ " x 1 ¹ / ₂ "	250/cs.
16200636	CI8D714	OPS Dome Lid for PCS7014, Clear	250/cs.
16200251	PCS81116	64 ³ / ₁₀ oz., 8 ⁹ / ₁₆ " x 11 ³¹ / ₃₂ " x 1 ³ / ₄ "	250/cs.
16200648	CI881116	OPS Dome Lid for PCS81116, Clear	250/cs.

Ebony Premier® - Black

16200852	PEP4512	13 oz., 4 ⁷ / ₈ " x 5 ²⁹ / ₃₂ " x 1 ¹ / ₄ "	1000/cs.
16200600	PEP5613R	14 ¹ / ₂ oz., 4 ²⁹ / ₃₂ " x 6 ¹⁷ / ₃₂ " x 1 ³ / ₈ "	500/cs.
16201504	PEP5615	16 ⁴ / ₅ oz., 4 ¹⁹ / ₁₆ " x 6 ⁷ / ₃₂ " x 1 ¹¹ / ₁₆ "	500/cs.
16200599	PEP5713R	21 ³ / ₁₀ oz., 5 ¹⁵ / ₃₂ " x 7 ¹⁵ / ₃₂ " x 1 ³ / ₈ "	500/cs.
16201503	PEP6816	32 oz., 6 ¹ / ₃₂ " x 7 ¹⁵ / ₁₆ " x 1 ³ / ₄ "	500/cs.
16209122	PEP6815	36 ⁷ / ₁₀ oz., 6 ⁹ / ₁₆ " x 8 ³ / ₄ " x 1 ⁵ / ₈ "	250/cs.
16209121	PEP7014	45 oz., 7 ¹⁵ / ₃₂ " x 9 ³¹ / ₃₂ " x 1 ¹ / ₂ "	250/cs.

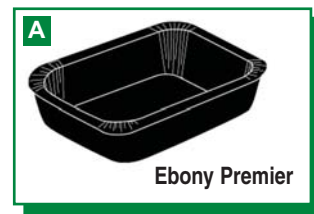

REUSABLE BAGS

B. PRIME SOURCE® SHOPPING BAGS PRIME SOURCE®

Eco-friendly reusable fabric shopping bag. This attractive, long-lasting, non-woven shopping bag folds into a compact 7" x 6¹/₂" pack, making it easy to carry when you shop.

76008624	76008624	13 ¹ / ₂ " x 16 ¹ / ₂ " x 15", Black	100/bdl.
76008620	76008620	13 ¹ / ₂ " x 16 ¹ / ₂ " x 15", Green	100/bdl.
76008622	76008622	13 ¹ / ₂ " x 16 ¹ / ₂ " x 15", Navy	100/bdl.
76008621	76008621	13 ¹ / ₂ " x 16 ¹ / ₂ " x 15", Red	100/bdl.
76008623	76008623	13 ¹ / ₂ " x 16 ¹ / ₂ " x 15", Yellow	100/bdl.



C. GRAY IS THE NEW GREEN BAG™ HILEX POLY

Dispensing system designed for maximum checkout productivity. Patented EZ open feature. Shopper friendly T-shirt style handles. Adaptive hardware to fit almost any checkstand application. Integral tab improves housekeeping - no tab waste to remove.

18302101	4000001	1/6, 12" x 7" x 22", 13 MIC,	1000/cs.
----------	---------	------------------------------	----------



D. HIPPO SAKS™ CROWN POLY

Preserves our environment by reducing bag usage more than 25%. Can hold the groceries of 3-4 non-reinforced bags because of our reinforced bottom seal. Supports source reduction (EPA's #1 waste prevention method). No leaks or bottom holes. 100% recyclable. Made from U.S. polyethylene derived from natural gas, not crude oil.

Hippo 8 Bags

28168113	T80013	12 ¹ / ₂ " x 7 ¹ / ₂ " x 20 ³ / ₅ ", Natural, 13.5 MIC, HMW - HDPE & LLDPE	1400/cs.
28160051	T89999	12 ¹ / ₂ " x 7 ¹ / ₂ " x 20 ³ / ₅ ", Green, Eco, 15.5 MIC, 100% Post Industrial Recycled Resin	1300/cs.

Hippo 12 Bags

28160373	T30373	12 ¹ / ₂ " x 7 ¹ / ₂ " x 24", White, Thank You, 13.5 MIC, HMW - HDPE & LLDPE	1300/cs.
28168013	T38013	12 ¹ / ₂ " x 7 ¹ / ₂ " x 24", Natural, Enviro, 13.5 MIC, HMW - HDPE & LLDPE	1300/cs.
28168015	T38015	12 ¹ / ₂ " x 7 ¹ / ₂ " x 24", Natural, Enviro, 15.5 MIC, HMW - HDPE & LLDPE	1100/cs.
28168017	T38017	12 ¹ / ₂ " x 7 ¹ / ₂ " x 24", Natural, Enviro, 17.5 MIC, HMW - HDPE & LLDPE	1000/cs.
28169999	T39999	12 ¹ / ₂ " x 7 ¹ / ₂ " x 24", Green, Eco, 16.5 MIC, 100% Post Industrial Recycled Resin	1050/cs.



GREEN



Food Bag & Wraps/Pan Liner

GREEN



FOOD BAG & WRAPS

A. ECO-CRAFT® SANDWICH BAG BAGCRAFT

Less mess with grease-resistant paper. Hot or cold applications and microwaveable. Easy-to-eat convenience for single portions.

16400100	<i>300100</i>	6½" x 11" x 8", #25, Natural Kraft	4000/cs.
-----------------	---------------	------------------------------------	----------



B. ECO-CRAFT® INTERFOLDED SHEETS BAGCRAFT

Excellent moisture barrier with soy wax blend. Quick sanitary pick-up and handling.

Separates assorted baked and deli goods. Easy release fresh or frozen.

16401001	<i>010001</i>	6" x 10¾", Natural Kraft	10,000/cs.
16401608	<i>016008</i>	8" x 10¾", Natural Kraft	6000/cs.
16401601	<i>016010</i>	10" x 10¾", Natural Kraft	6000/cs.
16406012	<i>016012</i>	12" x 10¾", Natural Kraft	6000/cs.



C. ECO-CRAFT® DELI WRAP BAGCRAFT

Grease-resistant multi-purpose sandwich wrap/basket liner. Hot or cold applications and microwaveable. Easy to eat convenience for single portions.

16400897	<i>300897</i>	12" x 12", Natural Kraft	5000/cs.
10906380	<i>300898</i>	15" x 16", Natural Kraft	3000/cs.



PAN LINER

D. ECO-BAKE PAN LINER BAGCRAFT

Comparable to a silicone grease-proof baking sheet but without the chromium. Manufactured from chlorine-free pulp. Excellent heat retention for baking of high moisture items; can be used at temperatures up to 425°F. Printed, 100% recycled.

16400180	<i>030010</i>	16¾" x 24¾", Medium Temperature	1000/cs.
-----------------	---------------	---------------------------------	----------

All Purpose Cleaners & Degreasers



ALL PURPOSE CLEANERS & DEGREASERS

A. ENVIRO PATROL OXIDE2 CARROLL

Multi-surface cleaner, deodorizer and stain remover. Fortified with hydrogen peroxide. Couples and organic solvent derived from orange and citrus peels with hydrogen peroxide, creating a cleaning solution with unequalled ability to dissolve and emulsify soils of all types. Absolutely superior cleaning ability without the use of a petroleum solvent or glycol ethers (butyl cellosolve). It penetrates and emulsifies for easy removal of oils and soils from any washable surface. The hydrogen peroxide cleans stains and takes odor away - safely and instantly. Dilutes at 2 oz./gal. (1:64) for most applications. Cold water effective.

30010196 19623 1 qt. RTU, Low Human Toxicity 12/cs.
30010197 19628 1 gal., Low Human Toxicity 4/cs.



B. ENVIRO PATROL HEAVY-DUTY CLEANER CARROLL

A high performance, extra strength heavy-duty cleaner and degreaser for the toughest of cleaning jobs, from the kitchen to the industrial plant. Replaces conventional kitchen and industrial cleaner/degreasers with an effective environmentally preferable alternative. Quickly removes petroleum-based soils including motor oil, lithium grease, lubricant oils, hydraulic fluid and stamping oil. Use for spray-on/wipe-off cleaning, mop and bucket, automatic scrubbing, pressure washer, or manual cleaning procedures. Dilutes at 1 oz./gal. (1:128) for most applications. This product has been 3rd Party Certified by Green Seal® according to GS-37 Environmental Standard and is recognized by the U.S. Environmental Protection Agency Design for the Environment (DfE) Formulator Initiative for its improved environmental and human health characteristics. Cold water effective.

30011982 19828 1 gal., Green Seal® (DfE) 4/cs.



C. ENVIRO PATROL MULTI-PURPOSE CLEANER CARROLL

Use as a high performance multi-surface cleaner, daily non-alkaline floor cleaner, scrub/recoat detergent, window cleaner, washroom cleaner, odor neutralizer, tile/grout cleaner and brightener, and carpet care product. Dilutes at 1 oz./gal. (1:128) for most applications. This product has been 3rd Party Certified by Green Seal® according to GS-37 Environmental Standard and is recognized by the U.S. Environmental Protection Agency Design for the Environment (DfE) Formulator Initiative for its improved environmental and human health characteristics. Cold water effective.

30018528 18528 1 gal., Green Seal® (DfE) 4/cs.



D. ENVIRO PATROL GLASS & SURFACE CLEANER CARROLL

Use as a high performance glass and utility cleaner. It can be used as a spray and wipe glass cleaner or with a sponge and squeegee. Leaves no residues. Helps prevent resoiling. Use on Plexiglas®, windows, windshields, walls, countertops, cabinets, partitions, light fixtures, stainless steel, chrome, plastic, vinyl and other hard surfaces not harmed by water. Dilutes at 1 oz./gal. (1:128) for most applications. This product has been 3rd Party Certified by Green Seal® according to GS-37 Environmental Standard. Cold water effective.

30018228 18228 1 gal. Green Seal® 4/cs.



E. GREEN WORKS™ NATURAL ALL PURPOSE CLEANER CLOROX

From the kitchen to the bathroom, our natural all purpose cleaner cuts grease, grime and dirt as well as traditional cleaners. But because it's made from plants and minerals it leaves no harsh chemical fumes or residue. Performs as well as the leading conventional cleaner. Safe on counters, appliances, stainless steel, sealed granite, chrome, cook top hoods, sinks and toilets. Ready-to-use formula.

38380456 00456 32 oz. 12/cs.
38380457 00457 64 oz., Refill 6/cs.



F. GREEN WORKS™ NATURAL DILUTABLE CLEANER CLOROX

Works on grease, grime and dirt. Is safe on multiple surfaces throughout the kitchen and bathroom, including non-wood floors, counters, sinks, stoves, garbage cans and toilets. Performs as well or better than the leading conventional cleaners. Dilutable formula (concentrate).

38380458 00458 64 oz. 6/cs.



GREEN

All Purpose Cleaners & Degreasers



A. MURPHY® OIL SOAP COLGATE-PALMOLIVE

Economical, natural cleaner is ideal for mopping wood floors, paneling and other large wood surfaces. Naturally cleans finished and hard surfaces. EPA DfE approved formula.

11901101	01101	16 oz.	12/cs.
11902106	01106	32 oz., Concentrate	12/cs.
11900103	01103	1 gal., Concentrate	4/cs.



B. AJAX® SCOURING CREAM CLEANER COLGATE-PALMOLIVE

No harsh abrasives. Fresh lemon scent. Perfect for modern surfaces; polishes and destains to keep surfaces looking new. Especially effective on vertical surfaces.

11901170	04941	24 1/2 oz.	9/cs.
----------	-------	------------	-------



C. FABULOSO® ALL PURPOSE CLEANER COLGATE-PALMOLIVE

Cleans and leaves a long-lasting fresh scent. Effective for a wide variety of cleaning applications. Advanced technology formula penetrates deep into surface to capture grease and soils. Neutral pH makes product safe for people and surfaces. No alkaline builder to leave a residue. No-rinsing step needed in floor cleaning applications. All cleaning agents are compostable. Bilingual labeling.

11904307	04307	1 gal., Lavender	4/cs.
11904373	04373	1 gal., Ocean Cool	4/cs.



D. SIMPLE GREEN® ALL PURPOSE CLEANER/DEGREASER SIMPLE GREEN

Versatile all purpose cleaner is non-toxic and compostable, without harmful bleach or ammonia. Because it is a concentrate, you can use Simple Green full strength or add water to clean just about anything.

73433016	13006	5 gal.	1/ea.
----------	-------	--------	-------



E. SIMPLE GREEN® CLEAN BUILDING™ ALL PURPOSE CLEANER CONCENTRATE SIMPLE GREEN

Formulated for cleaning all water-safe hard surfaces. Concentrate offers economical dilution, and with no fragrance or volatile organic ingredients, it doesn't adversely impact indoor air quality. Green color makes it easily identified when diluted into secondary containers. Non-toxic, compostable, non-caustic, and non-flammable. Makes 65 gallons of ready-to-use cleaner.

73431001	11001	1 gal., Green Seal®	2/cs.
----------	-------	---------------------	-------



F. CRYSTAL SIMPLE GREEN® INDUSTRIAL STRENGTH CLEANER/DEGREASER SIMPLE GREEN

Safe, effective and powerful all purpose cleaner/degreaser for critical cleaning applications that demand a fragrance-free solution. Non-toxic, non-abrasive and no caustic fumes. Exempt from OSHA and EPA special handling and personal protection requirements. Approved for use in federally inspected meat and poultry plants, and meets Montreal Protocol Guidelines and FDA requirements for cleaning cosmetics, medical and pharmaceutical environments. Excellent for use in parts washers, pressure washers, floor scrubbers and other mechanized applicators.

73439128	19128	1 gal.	6/cs.
----------	-------	--------	-------



G. Z-VERDANT RTU CLEANER ZEP

Environmentally preferred, easy-to-use cleaner for use on multiple surfaces and tough soils. May be used on any surface not harmed by water. Easily breaks down common soils making it an excellent everyday cleaner. Contains no harmful solvents or harsh chemicals.

75070100	R06901	1 qt.	12/cs.
75070101	R06935	5 gal.	1/ea.



H. VOC COMPLIANT SOLVENT DEGREASER ZEP

Environmentally preferred, solvent-based degreaser with d-limonene for use where a water-free formula is preferred. Meets all CA-CARB and OTC requirements.

75070113	R07824	1 gal.	4/cs.
75070114	R07835	5 gal.	1/ea.

GREEN

Glass Cleaners/Dishwash/Disinfectant/Restroom



GLASS CLEANERS

A. GREEN WORKS™ NATURAL GLASS & SURFACE CLEANER CLOROX

Clean without leaving anything behind; like harsh chemical fumes or residue. Our natural glass and surface cleaner is the natural way to get a streak-free clean. The plant and mineral-based ingredients work as well as traditional cleaners to cut through filmy residue. Safe on glass, mirrors, appliances, stainless steel and sealed granite.

38380459	00459	32 oz., Trigger Sprayer	12/cs.
38380460	00460	64 oz., Refill	6/cs.



B. AJAX EXPERT® GLASS & MULTI-SURFACE CLEANER COLGATE-PALMOLIVE

Powerful ready-to-use formula requires no mixing and is convenient to use. Dual solvent system cuts through film and grease fast. Contains ammonia for extra cleaning power. Flash dries quickly without streaking or filming. Use on glass, countertops, mirrors and other hard washable surfaces. Contains compostable surfactants. Bilingual labeling. Ready-to-use bottles include trigger sprayers.

11901320	04195	1 gal., Concentrate	4/cs.
-----------------	-------	---------------------	-------



C. SIMPLE GREEN® CLEAN BUILDING™ GLASS CLEANER CONCENTRATE SIMPLE GREEN

Specifically for streak and smear-free cleaning of glass and other reflective surfaces. Concentrate offers economical use dilution, with no added fragrance or volatile organic ingredients that can adversely impact indoor air quality. Also safe to use on plastics. Non-toxic, compostable, non-caustic, and non-flammable formulation. Makes 31 gallons of ready-to-use cleaner.

73431201	11201	1 gal.	2/cs.
-----------------	-------	--------	-------



HAND LIQUID DISHWASH

D. PALMOLIVE® PLUS DISHWASHING LIQUID COLGATE-PALMOLIVE

Cuts through stubborn grease. Rich, thick formula removes dried-on, cooked-on food. pH balanced. Long-lasting performance makes it an economical choice.

11901702	01410	3¼ oz., Green	72/cs.
11901640	04910	1 gal., Green	4/cs.
11901660	04911	5 gal., Green	1/ea.



E. ULTRA PALMOLIVE® DISHWASHING LIQUID FOR POTS & PANS COLGATE-PALMOLIVE

Highly concentrated formula tackles the toughest foodservice dishwashing tasks. Ideal for use as a presoak. Great as a general all purpose cleaner, its grease-cutting ability makes it perfect for cleaning tables, countertops, windows, mirrors and more. Ocean Breeze scent.

11900056	40043	1 gal.	4/cs.
-----------------	-------	--------	-------



LIQUID DISINFECTANT

F. BROAD SPECTRUM DISINFECTANT CLEANER ZEP

Environmentally preferred, ready-to-use germicidal cleaner and deodorant. Effective on mold and mildew. Conforms to CDC blood borne pathogen procedures for environmental services. Kills Parvo, Tuberculosis, HIV 1, MRSA, and Staph.

75070031	R02301	1 qt.	12/cs.
75070032	R02324	1 gal.	4/cs.



RESTROOM CLEANERS

G. ENVIRO PATROL RESTROOM CLEANER CARROLL

Use as a high performance washroom general purpose cleaner. Concentrated cleaner for removal of soap scum, mildew, lime, water scale and rust deposits on porcelain, tile, ceramic tile and fiberglass surfaces. Safe for daily use on painted surfaces, porcelain, porcelain enamel, aluminum or stainless steel without etching or damaging them. Dilutes at 1 oz./gal. (1:128) for most applications. This product has been 3rd party Certified by Green Seal® according to GS-40 Environmental Standard. Cold water effective.

30014402	44028	1 gal., Green Seal®	4/cs.
-----------------	-------	---------------------	-------



GREEN

Restroom/Deodorant/Soap & Hand Cleaners



A. GREEN WORKS™ NATURAL BATHROOM CLEANER CLOROX

A clean bathroom no longer has to equal harsh chemical fumes. The plant and mineral-based ingredients cut through soap scum, hard water and rust, leaving bathrooms naturally clean. Safe on bathroom counters, sinks, tub, tiles and shower doors.

38380452 00452 24 oz. 12/cs.



B. GREEN WORKS™ NATURAL TOILET BOWL CLEANER CLOROX

Works on tough stains, rust, mineral deposits and hard water. Angled neck design makes cleaning under the rim easier. Since it's made with plant and mineral-based ingredients, it's better for the environment. No bleach or phosphorous.

38380451 00451 24 oz., RTU 12/cs.



C. SIMPLE GREEN® CLEAN BUILDING™ BATHROOM CLEANER CONCENTRATE SIMPLE GREEN

Specifically formulated for cleaning scale and scum types of soils typically found on hard bathroom surfaces. Pink color makes it easily identified when diluted into secondary containers. Safe to use on washable hard surfaces such as ceramic, glazed tile, Corian®, Formica®, grout, faucets and fixtures, porcelain, and cured fiberglass. Non-toxic, compostable, non-caustic, and non-flammable. Makes 21 gallons of ready-to-use cleaner.

73431101 11101 1 gal., Green Seal® 2/cs.



D. NON-ACID DEODORIZING TOILET BOWL CLEANER ZEP

Environmentally preferred, non-acidic cleaner and deodorizer, removes scale, stains, and scum. Use on toilet bowls, tiles, sinks, showers, and bathroom fixtures.

75070006 R00301 1 qt. 12/cs.



E. BIOLOGICAL DRAIN MAINTAINER ZEP

Environmentally preferred drain maintenance product powered by enzymatic activity. Safe for use in septic systems to keep drains free flowing. A biological solution for safe maintenance.

75070036 R02635 5 gal. 1/ea.



LIQUID DEODORANT

F. Z-FRESH ODOR NEUTRALIZER ZEP

Environmentally preferred, highly effective odor neutralizer. Chemically eliminates the source of odors and replaces them with a pleasant clean fragrance.

75070022 R01601 1 qt., Breeze 12/cs.

75070025 R01901 1 qt., Potpourri 12/cs.

75070026 R02001 1 qt., Subdue 12/cs.

SOAP & HAND CLEANERS



G. PRIME SOURCE® G2 FOAM SOAP PRIME SOURCE®

A mild, compostable foam soap formula. Green Seal® and EcoLogo™ approved.

75004261 75004261 1200 mL, Green Seal® 2/cs.

75004260 75004260 1250 mL, Green Seal® 3/cs.

75004262 75004262 1500 mL, Green Seal® 2/cs.



H. GOJO® GREEN CERTIFIED FOAM HAND CLEANER GOJO

A mild, compostable foam soap formula certified by Green Seal® and EcoLogo™ to meet their joint standard (GS41/CCD-104) for hand cleaners and hand soaps.

35405715 571506 7½ oz., Tabletop Bottle, Green Seal® 6/cs.

35405725 572502 46 oz., Refill Bottle, Green Seal® 2/cs.

35405665 566502 1200 mL, Fits TFX™, Green Seal® 2/cs.

35405166 516503 1250 mL, Fits FMX-12™, Green Seal® 3/cs.

35408560 856502 1500 mL, Fits CX™/CXi™, Green Seal® 2/cs.

35405266 526502 2000 mL, Fits FMX-20™, Green Seal® 2/cs.

Hand Cleaners/Floor Care



A. GOJO® GREEN CERTIFIED LOTION HAND CLEANER GOJO

A mild, compostable lotion soap formula certified by Green Seal® and EcoLogo™ to meet their joint standard (GS41/CCD-104) for hand cleaners and hand soaps.

35406512	<i>916512</i>	800 mL, Green Seal®	12/cs.
35402165	<i>216508</i>	1000 mL, Fits NXT®, Green Seal®	8/cs.



B. SOY INDUSTRIAL HAND CLEANER ZEP

Environmentally preferred hand cleaner. Uses a powerful yet mild combination of soy solvents and walnut shell abrasive to loosen tough grime. Apple cinnamon fragrance.

75070080	<i>R05324</i>	1 gal.	4/cs.
-----------------	---------------	--------	-------

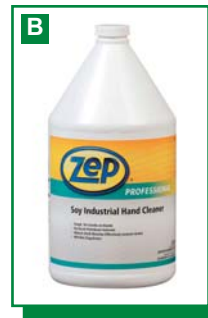

C. PURELL® GREEN CERTIFIED INSTANT HAND SANITIZER GOJO

Made from 100% naturally renewable ethanol. Meets the USDA BioPreferred program for biobased content. Readily compostable gel formula. Meets the EcoLogo™ hand sanitizer standard CCD-170 for environmental leadership and proven performance.

35400219	<i>969112</i>	8 oz. Bottle	12/cs.
35400221	<i>369112</i>	12 oz. Bottle	12/cs.
35400222	<i>509103</i>	1200 mL, Fits FMX™	3/cs.
35400218	<i>549104</i>	1200 mL, Fits FMX™	4/cs.



D. PURELL® GREEN CERTIFIED INSTANT HAND SANITIZER FOAM GOJO

Made from 100% naturally renewable ethanol. Meets the USDA BioPreferred program for biobased content. Readily compostable non-aerosol foam formula. Meets the EcoLogo™ hand sanitizer standard CCD-170 for environmental leadership and proven performance.

35400223	<i>579104</i>	535 mL Bottle	4/cs.
35400224	<i>519103</i>	1200 mL, Fits FMX™	3/cs.
35400217	<i>539102</i>	1200 mL, Fits TFX™	2/cs.



E. PURELL® INSTANT HAND SANITIZER SKIN NOURISHING FOAM GOJO

Non-aerosol, alcohol-based foam sanitizer with the exclusive Dermaglycerin System™. Clinically proven to improve healthcare worker skin hydration in 14 days. Contains seven moisturizers for optimal skin conditioning. Fragrance-free, dye-free. Compatible with latex, nitrile and vinyl gloves and CHG. Meets CDC and APIC recommendations.

35409804	<i>579804</i>	535 mL, Pump Bottle	4/cs.
35405398	<i>539802</i>	1200 mL, Fits TFX™	2/cs.
35400183	<i>519803</i>	1200 mL, Fits FMX-12™	3/cs.



FLOOR CARE

F. ENVIRO PATROL NEUTRAL CLEANER CARROLL

Quickly removes soil without dulling, damaging, etching, or harming floor finishes even when used for daily applications. Dilutes at 1 oz./gal. (1:128) for most applications. This product has been 3rd Party Certified by Green Seal® according to GS-37 Environmental Standard and is recognized by the U.S. Environmental Protection Agency Design for the Environment (DfE) Formulator Initiative for its improved environmental and human health characteristics. Cold water effective.

30011272	<i>12728</i>	1 gal., Green Seal® (DfE)	4/cs.
-----------------	--------------	---------------------------	-------



G. BROAD SPECTRUM DISINFECTANT FLOOR CLEANER ZEP

Environmentally preferred neutral floor and hard surface cleaner disinfects floors and hard surfaces. Hospital grade disinfectant eliminates bacteria, fungi and viruses including HIV, MRSA, and Staph.

75070027	<i>R02124</i>	1 gal.	4/cs.
75070028	<i>R02135</i>	5 gal.	1/ea.



H. Z-VERDANT ALL PURPOSE CLEANER ZEP

Environmentally preferred, concentrated, all purpose cleaner. May be used on any surface not harmed by water. Effective on a variety of soils such as wax buildup, fingerprints, and black marks on floors. May be used for most daily cleaning and maintenance operations. Contains no harmful solvents or harsh chemicals.

75070133	<i>R08924</i>	1 gal.	4/cs.
75070134	<i>R08935</i>	5 gal.	1/ea.



GREEN

Floor Care/Carpet Care



A. Z-VERDANT AUTO SCRUBBER SOLUTION ZEP

Environmentally preferred auto scrubber concentrate. Removes oil, grease, and dirt from floors and most other washable surfaces. Compostable, no petroleum, solvents or caustics.

75070129	R08724	1 gal.	4/cs.
75070130	R08735	5 gal.	1/ea.

B. ENVIRO PATROL WAX & FINISH REMOVER CARROLL

High performance, ultra low odor, non-toxic, non-corrosive, butyl-free, ammonia-free wax and finish remover. Dissolves multiple coats of finish without the unpleasant odor associated with conventional strippers. Rinses quickly without leaving residual alkali to interfere with finish application. Dilute 1 part to 6 parts of cold water for most applications. This product has been 3rd party Certified by Green Seal® according to GS-40 Environmental Standard and is recognized by the U.S. Environmental Protection Agency Design for the Environment (DfE) Formulator Initiative.

30011276	35028	1 gal., AE, Green Seal® (DfE)	4/cs.
30011274	35019	5 gal., Green Seal® (DfE)	1/ea.

C. ENVIRO PATROL METAL-FREE FLOOR FINISH CARROLL

Designed with the newest in environmentally preferable metal-free polymer technology for sealing and finishing all types of resilient flooring. Contains NO zinc, phthalates or alkyl phenol ethoxylates. Exceptional gloss, durability, soil resistance, detergent resistance, recoatability, removability, and slip resistance. Dries to a smooth, hard, clear and colorless coating in about 30 minutes under normal conditions. This product has been 3rd party Certified by Green Seal® according to GS-40 Environmental Standard and is recognized by the U.S. Environmental Protection Agency Design for the Environment (DfE) Formulator Initiative. Cold water effective.

30016728	66728	1 gal., AE, Green Seal® (DfE), Metal-Free	4/cs.
30010667	66719	5 gal., AE, Green Seal® (DfE), Metal-Free	1/ea.
30011275	66719	5 gal., AE, Green Seal® (DfE), Enviro Patrol	1/ea.

D. Z-TREAD BURNISH RESTORER ZEP

Environmentally preferred, concentrated, floor gloss restorer cleans and prepares floor for burnishing in one easy step. Eliminates need for frequent stripping and refinishing.

75070058	R03835	5 gal.	1/ea.
----------	--------	--------	-------

CARPET CARE

E. SIMPLE GREEN® CLEAN BUILDING™ CARPET CLEANER CONCENTRATE SIMPLE GREEN

Formulated especially for cleaning carpets and rugs. Green Seal® Certified and also CRI Certified. Carpet warranties that call for the use of only CRI-approved products will not be jeopardized. No added fragrance or volatile organic ingredients. Non-toxic, compostable, non-caustic, and non-flammable. Makes 22 gal. of ready-to-use cleaner.

73431301	11301	1 gal., Green Seal®	2/cs.
----------	-------	---------------------	-------

F. HIGH FOAM CARPET SHAMPOO ZEP

Environmentally preferred carpet shampoo designed for deep cleaning. "Dry" foam allows for rapid drying and a quicker return to use. Inhibits surface resoiling and leaves behind a fresh fragrance. Safe on stain-resistant treated carpets.

75070015	R01124	1 gal.	4/cs.
75070016	R01135	5 gal.	1/ea.

G. LEMONGRASS CARPET EXTRACTION SOLUTION ZEP

Environmentally preferred carpet cleaner with light lemongrass fragrance. Designed for hot water extraction or bonnet method carpet cleaning. Safe on stain-resistant treated carpets. Friable surfactants dry to a powder which are easily vacuumed up leaving no residue behind.

75070009	R00624	1 gal.	4/cs.
75070010	R00635	5 gal.	1/ea.

H. BIOENZYMATIC CARPET SPOTTER ZEP

Environmentally preferred, biologically-based carpet spotter removes tough stains from carpets through combined detergent and enzymatic action.

75070014	R01001	1 qt.	12/cs.
----------	--------	-------	--------

GREEN

Automotive/Toilet Tissue



AUTOMOTIVE

A. FOAMING VEHICLE SHAMPOO ZEP

Environmentally preferred, ultra-concentrated liquid detergent formulated for friction car and truck washing facilities. Excellent for removing road film, dirt and salt deposits. Won't harm wax finishes.

75070118	R08124	1 gal.	4/cs.
75070119	R08135	5 gal.	1/ea.



STANDARD TOILET TISSUE

B. GREEN SOURCE™ BATH TISSUE PRIME SOURCE®

100% recycled. Chlorine-free. EcoLogo™ Certified. Trilingual packaging (English, Spanish, French).

75009500	75009500	2-Ply	96/cs.
----------	----------	-------	--------

C. SCOTT® 100% RF STANDARD TOILET TISSUE KIMBERLY-CLARK

Made with 100% recycled fiber. Meets EPA standards for minimum post-consumer waste content (towels: 40%) and is Green Seal® Certified.

15406446	64460	605 ct., 4 1/2" x 4", White, 2-Ply, Green Seal®	80/cs.
----------	-------	---	--------



D. TORK® WHITE TOILET TISSUE SCA TISSUE

High capacity rolls eliminate service outages. Embossed. Banded rolls and easy start tail seals prevent waste and source reduction. Rapid breakup capabilities. TS1636S replaces TS1636. Made from 100% recycled fibers. Environmental Choice EcoLogo™ Certified.

Tork® Advanced - 1-Ply

14100086	110291A	2000 ct., 3 5/16" x 3 3/4" Sheets, 5 2/5" Roll dia.	36/cs.
----------	---------	---	--------

Tork® Universal - 1-Ply

14101640	TS1639A	1000 ct., 4" x 3 3/4" Sheets, 1-Ply	48/cs.
----------	---------	-------------------------------------	--------

14101637	TS1636S	1000 ct., 4" x 3 3/4" Sheets, 1-Ply	96/cs.
----------	---------	-------------------------------------	--------



JUMBO TOILET TISSUE

E. GREEN SOURCE™ JUMBO TOILET TISSUE PRIME SOURCE®

100% recycled. Chlorine-free. EcoLogo™ Certified. Trilingual packaging (English, Spanish, French).

75009505	75009505	2-Ply	12/cs.
----------	----------	-------	--------

F. SCOTT® 100% RF JRT JR. BATHROOM TISSUE KIMBERLY-CLARK

Made with 100% recycled fiber. Meets EPA standards for minimum post-consumer waste content (towels: 40%) and is Green Seal® Certified.

15406722	67223	3 5/8" x 2000', White, 1-Ply, Green Seal®	12/cs.
----------	-------	---	--------

15406780	67805	3 5/8" x 1000', White, 2-Ply, Green Seal®	12/cs.
----------	-------	---	--------



G. TORK® WHITE JUMBO TOILET TISSUE SCA TISSUE

T-Tork® - 1-Ply

High capacity provides fewer refills and reduces labor. Large size is pilfer proof. Reduced stub roll means less waste. Fewer cores and no wrappers leads to source reduction. Perforated. Made from 100% recycled fiber. Environmental Choice EcoLogo™ Certified.

14100055	1101042	3 5/8" x 2247', 1-Ply	6/cs.
----------	---------	-----------------------	-------

Tork® Advanced - 2-Ply

Quality jumbo toilet tissue. 100% recycled, Environmental Choice EcoLogo™ Certified.

14100920	TJ0921A	3 5/8" x 1000', 2-Ply	12/cs.
----------	---------	-----------------------	--------

Tork® Universal - 1-Ply

Soft, absorbent one-ply tissue delivers quality, value and performance. Rapid break-up capability. Core is designed to fit virtually all size jumbo tissue dispensers. Made from 100% recycled fibers. Environmental Choice EcoLogo™ Certified. 3 1/2" dia. core.

14100914	TJ0912A	3 5/8" x 2000', 1-Ply, 8 1/2" Roll dia.	12/cs.
----------	---------	---	--------

14101214	TJ1212A	3 5/8" x 4000', 1-Ply, 11 3/4" Roll dia.	6/cs.
----------	---------	--	-------

Tork® Advanced Mini - 1-Ply

High capacity provides fewer refills and reduces labor. Reduced stub roll means less waste. Fewer cores and no wrappers leads to source reduction. Less storage space is needed.

Made from 100% recycled fibers. Environmental Choice EcoLogo™ Certified. 2 1/2" dia. core.

14103902	12013902	3 5/8" x 1925', 1-Ply, 7 1/8" Roll dia.	12/cs.
----------	----------	---	--------



GREEN



Facial Tissue/Paper Towels



FACIAL TISSUE

A. SCOTT® 100% RF SURPASS FACIAL TISSUE KIMBERLY-CLARK

Made with 100% recycled fiber. Meets EPA standards for minimum post-consumer waste content (towels: 40%) and is Green Seal® Certified.

15401295	21295	Boutique, 110 ct., 8" x 8 ³ / ₁₀ ", White, 2-Ply	3960/cs.
15401285	21285	Flat, 125 ct., 8" x 8 ³ / ₁₀ ", White, 2-Ply	60/125/cs.



B. TORK® FACIAL TISSUE - FLAT BOXES SCA TISSUE

Soft and absorbent two-ply facial tissue offers the right combination of performance and value. Soft shield protects the tissues and provides easy, one-at-a-time dispensing. Ideal for the vanity or in-wall dispensers. Made from 100% recycled fibers, helps conserve natural resources. Dispenser box is manufactured from 100% recycled materials with a minimum of 15% post-consumer materials. Environmental Choice EcoLogo™ Certified.

Tork® Advanced

14106811	TF6810	100 ct., 8 ² / ₁₀ "W x 7 ⁹ / ₁₀ "L Sheets, White, 2-Ply	30/cs.
-----------------	--------	---	--------

Tork® Universal

14106710	TF6710A	100 ct., 8 ² / ₁₀ "W x 7 ⁹ / ₁₀ "L Sheets, White, 2-Ply	3000/cs.
-----------------	---------	---	----------



ROLL PAPER TOWELS

C. GREEN SOURCE™ ROLL TOWELS PRIME SOURCE®

100% recycled. Chlorine-free. EcoLogo™ Certified. Trilingual packaging (English, Spanish, French).

75009525	75009525	7 ³ / ₄ " x 300', Natural, Standard	12/cs.
75009520	75009520	7 ³ / ₄ " x 300', White, Standard	12/cs.
75009535	75009535	7 ³ / ₄ " x 700', Natural, Jumbo	6/cs.
75009530	75009530	7 ³ / ₄ " x 700', White, Jumbo	6/cs.



D. HI-VALU ROLL TOWELS PRIME SOURCE®

Hardwound roll towels. 100% recycled pulp.

73004333	73004333	7 ³ / ₄ " x 600', White	12/cs.
73004334	73004334	7 ³ / ₄ " x 600', Natural	96/cs.



E. SCOTT® 100% RF HARD ROLL TOWELS KIMBERLY-CLARK

Made with 100% recycled fiber. Meets EPA standards for minimum post-consumer waste content (towels: 40%) and is Green Seal® Certified.

15402031	02031	8" x 800', Natural, 1-Ply, Green Seal®	12/cs.
15401052	01052	8" x 800', White, 1-Ply, Green Seal®	12/cs.

F. TORK® HARDWOUND ROLL TOWELS SCA TISSUE

Tork® Advanced

Roll towels are soft, strong and highly absorbent and offer the perfect combination of quality, performance and value. Embossing enhances hand feel and maximum absorbency. Fewer towels are used per hand dry. Towels are made from 100% recycled fiber. Environmental Choice EcoLogo™ Certified. 1⁴/₈" core diameter.

14101350	RB350A	7 ⁷ / ₈ " x 350', White	12/cs.
14100600	RB600	7 ⁷ / ₈ " x 600', White	12/cs.
14100800	RB800	7 ⁷ / ₈ " x 800', White	6/cs.

Tork® Universal

Long-lasting rolls minimize maintenance costs while maximizing service. Towels are made from 100% recycled fiber. Environmental Choice EcoLogo™ Certified. 1⁴/₈" core, 5¹/₂" roll diameter.

14100104	RK206E	7 ⁷ / ₈ " x 206', Natural	24/cs.
14101351	RK350A	7 ⁷ / ₈ " x 350', Natural	12/cs.
14100351	RB351	7 ⁷ / ₈ " x 350', White	12/cs.
14106000	RK600E	7 ⁷ / ₈ " x 600', Natural	12/cs.
14100103	RK800E	7 ⁷ / ₈ " x 800', Natural	6/cs.



GREEN

Paper Towels



A. TORK® HAND ROLL TOWELS SCA TISSUE

Embossing enhances hand feel and maximum absorbency; fewer towels used per hand dry. Roll towel performance provides source reduction and less packaging. Long-lasting rolls minimize maintenance costs. Towels are made from 100% recycled fiber. Environmental Choice EcoLogo™ Certified.

Tork® Universal

14106002 RB6002 7¹/₈" x 600', White 12/cs.

Tork® Premium

14100050 RB425 7⁶/₁₆" x 425', White, Green Seal® 12/cs.

Tork® Basic

14100488 290088 7³/₄" x 700', Natural, Green Seal® 6/cs.



KITCHEN ROLL PAPER TOWELS

B. GREEN SOURCE™ KITCHEN ROLL TOWELS PRIME SOURCE®

100% recycled. Chlorine-free. EcoLogo™ Certified. Trilingual packaging (English, Spanish, French).

75009555 75009555 11", 210 ct., White, 2-Ply 12/cs.

C. TORK® ADVANCED PERFORATED ROLL TOWELS SCA TISSUE

Tork Advanced perforated roll towels have high bulk, two-ply construction that maximizes absorbency for superior spill holding power using fewer towels. Super strong soft towels hold together even on tough jobs. Ideal for cleaning and wiping all surfaces. SCA does not guarantee that this product will contain any recycled fiber. 5³/₁₀" roll diameter.

14100107 HB9201 120 ct., 11"W x 6³/₄"L, White, 2-Ply 30/cs.

D. TORK® UNIVERSAL KITCHEN ROLL TOWELS SCA TISSUE

High bulk, two-ply construction maximizes absorbency for superior spill holding power using fewer towels. Super strong soft towels hold together even on tough jobs. Ideal for cleaning and wiping all surfaces. Standard count gives you twice the toweling. Reduces replacement time, helps eliminate run-out, and saves storage and delivery costs. Made from 100% recycled fiber and meets the EPA compliant (minimum 90% Post-Consumer Content) providing environmental benefits, and a positive image. Replaces HK1975E. Environmental Choice EcoLogo™ Certified.

14101975 HK1975A 210 ct., 9" x 11", Natural, 2-Ply, Green Seal® 12/cs.



CENTERFEED PAPER TOWELS

E. TORK® CENTERFEED TOWELS SCA TISSUE

Tork centerfeed towels deliver one-at-a-time service and reduce waste. High capacity reduces labor and few or no moving parts means nothing to jam or break. High absorbency means that less towels are used. Touch only dispensing towel reduces cross-contamination. Made from 100% recycled fiber, providing environmental benefits. Environmental Choice EcoLogo™ Certified. 2⁹/₁₀" core dia.

Tork® Advanced Mini - White

14100385 121225 262', 8⁹/₁₀" x 11⁴/₅", 2-Ply 12/cs.

Tork® Universal - White

14100133 120133 1000 ct., 983', 7¹/₅" Roll dia., White, 1-Ply 6/cs.

14100105 121211 600 ct., 590', 7⁴/₅" Roll dia., White, 2-Ply 6/cs.

14100134 121202 610 ct., 600', 7⁴/₅" Roll dia., White, 2-Ply 6/cs.

14101230 121201 600 ct., 590', 7⁴/₅" Roll dia., White, 2-Ply 6/cs.



C-FOLD PAPER TOWELS

F. HI-VALU C-FOLD TOWELS PRIME SOURCE®

High quality and value priced. Ideal for all public environments.

73004304 73004304 150 ct., 10¹/₄" x 13", White 2400/cs.

G. SCOTT® 100% RF C-FOLD TOWELS KIMBERLY-CLARK

Made with 100% recycled fiber. Meets EPA standards for minimum post-consumer waste content (towels: 40%) and is Green Seal® Certified. White.

15402921 02920 200 ct., 10¹/₁₀" x 13¹/₅", 1-Ply, Green Seal® 2400/cs.



GREEN



Paper Towels



A. TORK® C-FOLD TOWELS SCA TISSUE

Soft and absorbent towels. Embossing enhances hand feel and maximum absorbency. High wet strength. Improved product design helps to control usage. 100% recycled chipboard sleeves assure maximum protection and ease of handling. Made from 100% recycled fiber. Environmental Choice EcoLogo™ Certified. 3¹³/₂₀" x 10¹/₈" folded.

Tork® Advanced
14100700 *CB520* 150 ct., 12³/₄" x 10¹/₈", White 2400/cs.

Tork® Universal
14100706 *CB530* 150 ct., 12³/₄" x 10¹/₈", White 2400/cs.

Tork® Premium
 Ultra soft and absorbent super premium towels. Deeply embossed towels enhance hand feel and maximize absorbency. Excellent wet strength. Made from 100% recycled fiber. Environmental Choice EcoLogo™ Certified. 3¹³/₂₀" x 10¹/₈" folded.
14101540 *CB510* 125 ct., 12³/₄" x 10¹/₈", White 2400/cs.



MULTIFOLD PAPER TOWELS

B. GREEN SOURCE™ MULTIFOLD TOWELS PRIME SOURCE®

100% recycled. Chlorine-free. EcoLogo™ Certified. Trilingual packaging (English, Spanish, French).

75009515 *75009515* Natural 4000/cs.
75009510 *75009510* White 4000/cs.



C. HI-VALU MULTIFOLD TOWELS PRIME SOURCE®

Universal paper towel are high quality and value priced. Ideal for all public environments.

73004307 *73004307* 200 ct., 9¹/₄" x 9¹/₂", Natural 4000/cs.
73004306 *73004306* 200 ct., 9¹/₄" x 9¹/₂", White 4000/cs.



D. SCOTT® 100% RF MULTIFOLD TOWELS KIMBERLY-CLARK

Made with 100% recycled fiber. Meets EPA standards for minimum post-consumer waste content (towels: 40%) and is Green Seal® Certified.

15401801 *01801* 250 ct., 9¹/₅" x 9²/₅", Natural, 1-Ply, Green Seal® 4000/cs.
15401807 *01807* 250 ct., 9¹/₅" x 9²/₅", White, 1-Ply, Green Seal® 4000/cs.

E. TORK® ADVANCED INTERFOLDED TOWELS SCA TISSUE

The unique interfolded system creates ready-to-use towels with no towel "fall out". Portion control delivers one towel every time. Easy to refill, reducing maintenance time and costs. Towels are made from 100% recycled fibers providing environmental benefits. Environmental Choice EcoLogo™ Certified.

14101291 *101291* 144 ct., 8⁹/₁₀" x 10" 3024/cs.



F. TORK® MULTIFOLD TOWELS SCA TISSUE

Soft and absorbent towels provide the right combination of quality, performance and value. Embossing enhances hand feel and maximum performance. Multifold design helps to minimize towel usage. Made from 100% recycled fibers. Environmental Choice EcoLogo™ Certified.

Tork® Advanced
14100550 *MB560A* 150 ct., 9¹/₂" x 9¹/₈", White 2400/cs.
14100551 *MB550A* 250 ct., 9¹/₂" x 9¹/₈", White, Green Seal® 4000/cs.

Tork® Universal
14100553 *MK518A* 250 ct., 9¹/₂" x 8¹/₁₀", Natural, Green Seal® 4000/cs.
14100520 *MK520A* 250 ct., 9¹/₂" x 9¹/₈", Natural, Green Seal® 4000/cs.
14100552 *MK530A* 250 ct., 9¹/₂" x 9¹/₈", Natural 4000/cs.
14100538 *MB540A* 250 ct., 9¹/₂" x 9¹/₈", White 4000/cs.



GREEN

Paper Towels/Hygiene/Wipers/Microfiber Cleaning



SINGLEFOLD PAPER TOWELS

A. TORK® UNIVERSAL SINGLEFOLD TOWELS SCA TISSUE

Tork Universal soft and absorbent towels provide the right combination of quality, performance and value. Embossing enhances hand feel and maximum performance. Singlefold design provides quality, people appreciate while working to reduce your overall costs and it fits all standard singlefold towel dispensers. Second fold creates a second 1/2" tab to aid dispensing. Towels are made from 100% recycled fibers providing environmental benefits, and a positive image builder. SB1840A replaces SB1840. SK1850A replaces SK1850E and SK1854E. Environmental Choice EcoLogo™ Certified.

14101855	SK1850A	250 ct., 10 1/4" x 9 1/8", Natural	4000/cs.
14101841	SB1840A	250 ct., 10 1/4" x 9 1/8", White	4000/cs.



HYGIENE

B. ENVIRO GARDS® ULTRA THIN MAXI PAD HOSPECO

A super absorbent sanitary napkin that is both flushable and compostable. Specially engineered, patented materials combine to make the only flushable and compostable sanitary napkin available for restroom feminine hygiene vending.

14502004	EG4	#4 Box	125/cs.
-----------------	-----	--------	---------

C. PAPER LINER HOSPECO

Kraft waxed paper liner. With gusset-wax finish. Fit Sanisac and #250, #201W, #ND1W, #ND1E receptacles. 100% recycled post-consumer waste.

14502200	260	10 1/4" x 7 1/2" x 3 1/2"	900/cs.
-----------------	-----	---------------------------	---------

D. HEALTH GARDS® TOILET SEAT COVER REFILLS HOSPECO

For environmentally concerned customers, Heath Gards Green toilet seat covers are made from recycled paper. 100% recycled, flushable and disposable.

14505001	GREEN5000	250 ct., 1/2 Fold, Green	5000/cs.
-----------------	-----------	--------------------------	----------

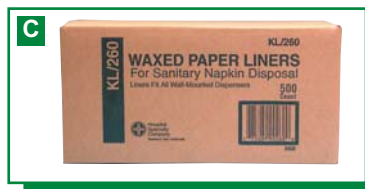

WIPERS

E. TOUGHWORKS™ 4-PLY SCRIM WIPERS HOSPECO

Strong, durable wipers made from multiple layers of tissue reinforced by a grid of threading. Superior wet strength. Low-lint. Multiple plies. Nylon reinforced for added strength. Ideal for smooth surfaces such as glass or stainless steel. 100% recycled post-consumer waste.

14509069	MC9069H	50 ct., 12" x 13", White, QF	900/cs.
14502302	MC2300H	150 ct., 9 3/4" x 17", White, IF	900/cs.
14502377	MC2375BH	9 3/4" x 275', Blue, Roll	6/cs.
14502378	MC2375H	9 3/4" x 275', White, Roll	6/cs.



MICROFIBER CLEANING TOOLS

F. WYPALL® MICROFIBER CLOTHS KIMBERLY-CLARK

Microfiber cloths with Microban® protection are durable, remarkably absorbent, and environmentally friendly. No chemicals needed. Cleans virtually any surface; wet, dry, or damp. Absorbs eight times its weight in liquid. Can be laundered 300 times. Color-coding helps reduce cross-contamination.

15403620	83620	15 3/4" x 15 3/4", Blue	24/cs.
15403630	83630	15 3/4" x 15 3/4", Green	24/cs.
15403980	83980	15 3/4" x 15 3/4", Red	24/cs.
15403610	83610	15 3/4" x 15 3/4", Yellow	24/cs.



G. GLASSIC™ MICROFIBER CLOTHS CCP

Ideal for cleaning soap, grease, or finger prints from windows, mirrors, and metal surfaces. Leaves a streak-free finish. Can be laundered five times more than 100% cotton towels.

27600228	E222022	10" x 7", Green, Mitt	12/cs.
27602222	E222000	12" x 12", Green, Cloth	12/cs.



H. SUPREMO™ MICROFIBER CLOTHS CCP

All purpose cleaning cloth. Great for dusting and cleaning all types of surfaces.

27602210	E221000	12" x 12", Blue	12/cs.
27602211	E220000	12" x 12", Green	12/cs.



GREEN

Microfiber Cleaning Tools



A. MICROFLEX™ DUSTER & REFILLS CCP

Flexible, thin foam frame allows for effective cleaning in tight, hard-to-reach areas. Frame accepts a hand held handle or either one of our Pro Flat mop handles for high area cleaning. Microfiber refill for durability and long product life. Simply rinse away dirt with water after every use. Duster refills available separately.

27606025	<i>E224000</i>	2" x 27", Complete	1/ea.
27602907	<i>E224100</i>	2" x 22", Refills	3/cs.



B. ERGOWORX™ TOUCHLESS MICROTEK CLEANING SYSTEM CCP

Designed to fit all the most popular plastic janitorial carts made, including those manufactured by Continental (old and new styles), RCP, Impact/White, Akro-Mils and most Chinese imports. Also designed to fit all the most popular stainless steel janitorial carts made, including those manufactured by Geerpres® and Royce-Rolls. The ErgoWorx™ Solution and Discharge buckets are made from Derma-Tek™, non-porous plastic so they are easy to clean and help maintain a professional appearance. The Auto-Discharge mop frame is made from durable glass-filled nylon. Non-ferrous, so it is safe for use in areas with MRI equipment and will not rust or corrode. The patented Auto-Discharge Mop Frame eliminates the need to touch the soiled/contaminated Microfiber mop head, preventing cross-contamination. System includes: (1) solution bucket w/perforated screen, (1) discharge bucket w/aluminum discharge rod and (1) auto-discharge microfiber mop frame. The Microfiber Trolley can be added to the SYS-5 to create a mobile cleaning system that is both compact and efficient. The 3" non-marking, all swivel casters provide finger touch mobility, ideal for tight hallways and small rooms. The MFT-5 is designed to accommodate common cleaning tools including a wet floor sign, microflex duster, wipes and RTU trigger sprayer bottles. Safe for use in areas with MRI equipment and will not rust or corrode.

27605050	<i>SYS5</i>	22" x 19 ⁷ / ₈ " x 11 ⁵ / ₈ ", Complete System	1/ea.
276050511	<i>SB5YW</i>	22" x 8" x 11 ¹ / ₈ ", Discharge Bucket w/Aluminum Discharge Rod	1/ea.
276012001	<i>MF5BK</i>	18" x 5 ⁵ / ₈ " x 1 ³ / ₄ ", Auto-Discharge Mop Frame, Black	1/ea.
27605052	<i>MFT5BK</i>	31 ³ / ₄ " x 23" x 38 ¹ / ₂ ", Trolley, Black	1/ea.



C. MICROFIBER REFILLS CCP

Super Pro II™ Microfiber Refills

Looped-end construction and durable microfiber for long product life. Made of 100% microfiber, it can be laundered 300 to 500 times when cared for properly. Perma-Stitch sewn border for extreme durability. Hook and loop attachment for easy installation and removal from frame. Can be used for damp or dry mopping.

27602991	<i>C103020</i>	5" x 20", Blue	10/cs.
27602998	<i>C108020</i>	5" x 20", Green	10/cs.
27602996	<i>C104020</i>	5" x 20", Red	10/cs.
27602995	<i>C107020</i>	5" x 20", Yellow	10/cs.
27602992	<i>C103026</i>	5" x 26", Blue	10/cs.
27602997	<i>C104026</i>	5" x 26", Red	10/cs.

Super Pro Finish Mop Microfiber Refill

Microfiber finish flat mop is looped end and constructed of high wet modulus rayon blend yarn that provides quick, controlled liquid release. The finish flat mop will cover a 20" wide swath. Unlike conventional finish mops, 100% of the floor finish goes onto the floor along with full contact of the refill to the surface allowing better productivity and less chemical wasted in the mop. Should be rinsed after every use.

27602980	<i>C106020</i>	5" x 20", Light Blue	6/cs.
-----------------	----------------	----------------------	-------

The Aggressor™ Microfiber Scrubbing Refill

Innovative combination of microfiber yarn and synthetic stiff brush fibers. Designed to remove debris stuck to the floor that normal "yarn only" microfiber flat mops cannot.

276001261	<i>C109020</i>	5" x 20", Blue/White	1/ea.
27600126	<i>C109020</i>	5" x 20", Blue/White	10/cs.



D. MICROFIBER PRO™ FLAT MOP HANDLE CCP

Made of lightweight, long-lasting aluminum that will not rust or corrode. Twist lock mechanism allows extendable handle to adjust from 39" to 60"

276071401	<i>C714000</i>	39" to 60"	1/ea.
27607140	<i>C714000</i>	39" to 60"	10/cs.

GREEN

Microfiber/Wet Mopping/Compostable Liners



A. MICROFIBER PRO II™ FLAT MOP FRAMES CCP

Lightweight design allows for dramatic improvements in labor productivity. Trapezoid head effectively cleans corners and edges. 360 degree swivel attachment for maneuvering in tight areas. Handle locking clip to secure handle to frame connector. Designed to complement our line of microfiber refills.

276071701	<i>C717018</i>	4¾" x 18", Blue/Silver	1/ea.
276071711	<i>C717024</i>	4¾" x 26", Blue/Silver	1/ea.
27607171	<i>C717024</i>	4¾" x 26", Blue/Silver	10/cs.



WET MOPPING

B. ROUGH RIDER™ CUT-END MOP HEAD CCP

Very absorbent strands make this mop great for foodservice and other general maintenance uses. Stands up to any floor surface including stone and concrete.

27602213	<i>A42213</i>	1¼" Headband, Large	12/cs.
-----------------	---------------	---------------------	--------



C. WAVEBRAKE® MOP BUCKET RUBBERMAID

The WaveBrake® mop bucket and wringer system reduces splashing, which means a safer environment, cleaner floors, and improved productivity.

177075661	<i>757088BLUE</i>	35 qt., Blue	1/ea.
------------------	-------------------	--------------	-------



D. WAVEBRAKE® SIDE-PRESS COMBOS RUBBERMAID

The WaveBrake® mop bucket and wringer system reduces splashing, which means a safer environment, cleaner floors and improved productivity. High efficiency side-press wringer. Lasts 58 times longer than comparative wringers. Tested to exceed 50,000 wringing cycles, average wringers perform approximately 860 cycles. Premium tubular steel and structural web molded plastic.

17707602	<i>758888BLUE</i>	35 qt., Blue	1/ea.
-----------------	-------------------	--------------	-------



COMPOSTABLE LINERS

E. COMP-LETE™ COMPOSTABLE BAGS FORTUNE PLASTICS

Offer superior strength and compostability. BPI's "Compostable Logo" is awarded to products that meet ASTM D6400, assuring end users and composters that the bags will biodegrade swiftly and safely during municipal, commercial, or household composting. Will not leave plastic residues in the finished compost. Made from MATER BI™ material. Ideal for collecting food scraps and yard trimmings for composting. Replacing non-degradable trash bags with compostable ones helps composters reduce processing, separation, and disposal costs while keeping consumers collection bins clean, which encourages participation.

13800092	<i>BIO3980R</i>	33 gal., 30" x 39", Natural, 0.80 MIL	250/cs.
13800088	<i>BIO4685R</i>	40-45 gal., 40" x 46", Natural, 0.85 MIL	200/cs.



F. BIOTUF™ COMPOSTABLE BAGS - LIGHT GREEN HERITAGE BAG

Tough on trash, easy on the environment. Superior strength designed for pre- and post-consumer food waste diversion programs. Excellent puncture and tear resistance. Proven lifting strength and load capacity. Odor control, dissipates moisture. Photodegrades if left by roadside. 100% ASTM D6400 Certified degradable, 100% compostable.

38996649	<i>Y6039SER01</i>	30 gal., 30" x 39", 1.2 MIL	125/cs.
38996650	<i>Y6848YER01</i>	32 gal., 34" x 48", 1 MIL	100/cs.
38996651	<i>Y8448YER01</i>	48 gal., 42" x 48", 1 MIL	100/cs.
38996652	<i>Y9460YER01</i>	64 gal., 47" x 60", 1 MIL	100/cs.



G. NATURE FRIENDLY® TRASH BAGS NATURE FRIENDLY PRODUCTS

Nature Friendly Products' trash and retailer bags are compostable, providing consumers with an eco-friendly alternative to traditional disposables. Made from a proprietary resin, they are completely compostable within 50-100 days in home and commercial composting facilities. These products are non-toxic and superior in strength and performance.

C6937003	<i>G105</i>	55 gal., Large, 0.9 MIL	100/cs.
C6937007	<i>G106</i>	69 gal., Large, 0.9 MIL	80/cs.



GREEN



Recycling Containers

GREEN



RECYCLING CONTAINERS

A. DESKSIDE RECYCLING CONTAINERS RUBBERMAID

An easy and effective way to recycle paper. Contains Post-Consumer Recycled Resin (PCR) exceeding EPA guidelines. Designed to be used in systems with existing office containers and accessories.

177029551	295573	13 ⁵ / ₈ qt., Small, Blue	1/ea.
177029561	295673	28 ¹ / ₈ qt., Medium, Blue	1/ea.
177029581	295773	41 ¹ / ₄ qt., Large, Blue	1/ea.

B. BRUTE® MOBILE OFFICE PAPER COLLECTION CONTAINER RUBBERMAID

Can serve as central collection containers or shipping containers, reducing the amount of handling. Heavy-duty wheels roll easily, even over steps or curbing. Transport recyclable waste with ease and efficiency.

177026361	263406	32 gal., Blue	1/ea.
-----------	--------	---------------	-------

C. BRUTE® RECYCLING CONTAINERS W/O LIDS RUBBERMAID

Easy to maneuver. Contains Post-Consumer Recycled Resin (PCR) exceeding EPA guidelines. Can serve as central collection containers or shipping containers, reducing the amount of handling. Transport recyclable waste with ease and efficiency.

177026211	2620DBLUE	Round, 20 gal., Dark Blue	1/ea.
177032061	263206	Round, 32 gal., Blue	1/ea.
177043061	264373	Round, 44 gal., Blue	1/ea.
177035371	353673	Square, 40 gal., 23 ¹ / ₂ " sq. x 28 ³ / ₄ "H, Blue	1/ea.

D. LARGE CAPACITY RECYCLING CONTAINERS RUBBERMAID

Large capacity recycling containers for any outdoor environment. Contains Post-consumer Recycled Resin (PCR) exceeding EPA guidelines. Station containers serve as a convenient central collection site for multiple work stations. Recommended for indoor and outdoor use. Perfect for large crowds and high traffic areas. Designed to withstand extreme weather and handling.

Glutton®			
177002641	256B73	56 gal., Blue	1/ea.
17700258	256LDBLUE	Bottle & Can Top For 256B, Dark Blue	1/ea.
Plaza®			
17700968	396873	Bottle & Can Container, 50 gal., Blue	1/ea.
17700969	396973	Paper, 50 gal., Dark Blue	1/ea.

E. RECYCLING CONTAINERS & TOPS RUBBERMAID

For use in areas of high paper generation, such as near copiers, printers and in mailrooms. Station containers serve as a convenient central collection site for multiple work stations. Recommended for indoor and outdoor use. Large capacity ideal for heavy traffic areas. Designed to withstand extreme weather and handling.

Slim Jim®			
177035481	354075	23 gal., Blue, 20"L x 11"W x 30"H	1/ea.
Half Round			
177035211	352006BLUE	21 gal., Blue	1/ea.
Square			
177080011	356806	19 gal., 14 ¹ / ₂ " sq. x 24"H, Blue	1/ea.
177035671	356973	23 gal., Blue	1/ea.
177039521	395873	35 gal., 19 ¹ / ₂ " sq. x 27 ⁵ / ₈ "H, Blue	1/ea.
177059051	395973	50 gal., 19 ¹ / ₂ " sq. x 34 ¹ / ₄ "H, Blue	1/ea.
Container Tops			
177027031	270388BLUE	Paper Recycling Top Fits 23 gal., Dark Blue	1/ea.
177026711	267360DBLUE	Swing Lid Fits 15 ⁷ / ₈ & 23 gal., Dark Blue	1/ea.
177027911	2791	Bottle & Can Recycling Top Fits 35 & 50 gal., Dark Blue	1/ea.
177059071	2794	Paper Recycling Top Fits 35 & 50 gal., Dark Blue	1/ea.

Matting



MATTING

A. CLEAN STEP SCRAPER MATTING

MILLENNIUM MAT

All-rubber mat ideal for any outside entryway. The superior molded tread aggressively scrapes shoes clean of dirt and grime and traps it into the base of the mat. Available in black only. Certified slip-resistant by the National Floor Safety Institute.

C5440150	14030500	3' x 5', Black	1/ea.
C5440151	14040600	4' x 6', Black	1/ea.



B. ECOGUARD® INDOOR MATTING

MILLENNIUM MAT

Made from 99% recycled material, EcoGuard is the most eco-friendly and ecologically responsible mat ever. Carpeted surface is made from 100% post-consumer PET plastic bottles. The all-rubber backing is made from used tires, preventing landfill waste.

C5440200	EG020304	2' x 3', Charcoal	1/ea.
C5440201	EG030504	3' x 5', Charcoal	1/ea.
C5440205	EG030508	3' x 5', Green	1/ea.
C5440202	EG031004	3' x 10', Charcoal	1/ea.
C5440206	EG031008	3' x 10', Green	1/ea.
C5440203	EG040604	4' x 6', Charcoal	1/ea.
C5440207	EG040608	4' x 6', Green	1/ea.



C. FLEX STEP ANTI-FATIGUE MATTING

MILLENNIUM MAT

Reduces fatigue and discomfort while increasing productivity. Air domes offer flexible and comfortable support, and low-profile beveled edges reduce the risk of tripping. Accepted by the American Podiatric Medical Association. Certified slip-resistant by the National Floor Safety Institute.

C5440300	24020300	2' x 3', Black	1/ea.
C5440301	24030500	3' x 5', Black	1/ea.



GREEN

Notes



GREEN

All Purpose Cleaners



ALL PURPOSE CLEANERS

A. PRIME SOURCE® TORNADO PLUS MULTI-PURPOSE CLEANER DEGREASER PRIME SOURCE®

Contains N.O.S. (sodium carbonate) for superior cleaning power.

76008504 76008504 3.78 L 4/cs.



B. PRIME SOURCE® ULTIMATE ALL PURPOSE CLEANERS PRIME SOURCE®

Powerful cleaning action. Use on wood, metal and painted surfaces. Clean, fresh fragrance. Concentrated all purpose cleaner with moderate alkalinity that will not dull or remove floor finishes. Safe for most washable surfaces.

75004000 75004000 18 oz. Aerosol 12/cs.

75004001 75004001 1 gal. 4/cs.

75004002 75004002 5 gal. 1/ea.



C. PRIME SOURCE® SUPERMARKET MIRACLE MULTI-SURFACE CLEANER & PROTECTOR PRIME SOURCE®

Protects surfaces from fingerprints and static electricity. For use on glass, Plexiglas®, mirrors, chrome, fiberglass, face shields and even computer monitors.

75004011 75004011 12 oz. Aerosol 12/cs.

D. ENVIROPATROL® CARROLL

Heavy-Duty Cleaner

A high performance, extra strength heavy-duty cleaner and degreaser for the toughest of cleaning jobs, from the kitchen to the industrial plant. Replaces conventional kitchen and industrial cleaner/degreasers with an effective environmentally preferable alternative. Quickly removes petroleum-based soils. Use for spray-on and wipe-off cleaning, mop and bucket, automatic scrubbing, pressure washer or manual cleaning procedures. Dilutes at 1 oz./gal. (1:128) for most applications. Green Seal® certified. Cold water effective.

30011982 19828 1 gal., Green Seal® (DfE) 4/cs.

Multi-Purpose Cleaner

Use as a high performance multi-surface cleaner, daily non-alkaline floor cleaner, scrub/recoat detergent, window cleaner, washroom cleaner, odor neutralizer, tile/grout cleaner and brightener and carpet care product. Dilutes at 1 oz./gal. (1:128) for most applications. This product has been 3rd Party Certified by Green Seal® according to GS-37 Environmental Standard and is recognized by the U.S. Environmental Protection Agency Design for the Environment (DfE) Formulator Initiative for its improved environmental and human health characteristics. Cold water effective.

30018528 18528 1 gal., Green Seal® (DfE) 4/cs.

Oxide2

Multi-surface cleaner, deodorizer and stain remover. Organic solvent derived from orange and citrus peels fortified with hydrogen peroxide creating a cleaning solution with unequaled ability to dissolve and emulsify soils of all types. Absolutely superior cleaning ability without the use of a petroleum solvent or glycol ethers (butyl cellosolve). It penetrates and emulsifies for easy removal of oils and soils from any washable surface. The hydrogen peroxide cleans stains and takes odor away - safely and instantly. Dilutes at 2 oz./gal. (1:64) for most applications. Cold water effective.

30010196 19623 1 qt. RTU, Low Human Toxicity 12/cs.

30010197 19628 1 gal., Low Human Toxicity 4/cs.



E. FORMULA 409® ALL PURPOSE CLEANER CLOROX

Specially formulated to cut grease on contact. Easy-to-use - no mixing required.

38380628 00628 22 oz., Trigger Sprayer 12/cs.



All Purpose Cleaners



A. GREEN WORKS® CLOROX

Natural All Purpose Cleaners

From the kitchen to the bathroom, our natural all purpose cleaner cuts grease, grime and dirt as well as traditional cleaners. But because it's made from plants and minerals it leaves no harsh chemical fumes or residue. Performs as well as the leading conventional cleaner. Safe on counters, appliances, stainless steel, sealed granite, chrome, cook top hoods, sinks and toilets. Ready-to-use formula. Recognized by the U.S. Environmental Protection Agency Design for the Environment (DfE) Formulator Initiative for its improved environmental and human health characteristics.

38380456 00456 32 oz. 12/cs.

38380457 00457 64 oz., Refill 6/cs.

Natural Dilutable Cleaner

Works on grease, grime and dirt. Is safe on multiple surfaces throughout the kitchen and bathroom, including non-wood floors, counters, sinks, stoves, garbage cans and toilets. Performs as well or better than the leading conventional cleaners. Dilutable formula (concentrate). Recognized by the U.S. Environmental Protection Agency Design for the Environment (DfE) Formulator Initiative for its improved environmental and human health characteristics.

38380458 00458 64 oz. 6/cs.



B. LEMON FRESH PINE-SOL® ALL PURPOSE CLEANER CLOROX

Improved grease-cutting formula. Dissolves splattered grease and food stains from appliances, countertops and cabinets. Cuts grease and food stains from laundry. Spot cleans carpets. Fresh lemon fragrance.

38385419 35419 144 oz., Lemon Fresh 3/cs.



C. LESTOIL® HEAVY-DUTY CLEANER CLOROX

Concentrated heavy-duty cleaner. Powers through grease and stains.

38383910 33910 28 oz. 12/cs.

D. PINE-SOL® ORANGE ENERGY™ ALL PURPOSE CLEANER CLOROX

Cleans, deodorizes and shines non-finished and no-wax floors, tiles, walls, sinks, countertops, microwaves, refrigerators, stoves, range hoods, deep fryers and more. Fresh orange fragrance leaves your house smelling like freshly peeled oranges.

38388744 41772 144 oz. 3/cs.

E. AJAX EXPERT® NO-RINSE MULTI-SURFACE CLEANERS COLGATE-PALMOLIVE

Excellent general purpose cleaner for hard, washable surfaces. Micro-emulsion technology formula penetrates deep into surfaces to suspend grease and soils for easy removal. All cleaning agents are biodegradable.

11901143 01143 2 oz. Packets 80/cs.

11904944 04944 1 gal. 4/cs.

F. AJAX® COLGATE-PALMOLIVE

All Purpose Cleaner

Grease-cutting formula removes tough dirt and grease. Fresh lemon scent. Flip cap dispenser gives controlled application and dilution. Use on all floors, bathtubs, walls, toilets, sinks and countertops. Add 1/4 cup to 1 gallon of water.

11900019 41197 32 oz. 12/cs.

Ammonial™ All Purpose Cleaner Liquid

Ammonial cleaning power for use on most hard washable surfaces. No rinse formula. Contains biodegradable surfactants.

11908230 04949 1 gal. 4/cs.

Disinfectant Creme Cleanser

Cleans, deodorizes, kills odor causing bacteria. Liquid formula clings to vertical surfaces. Fresh lime scent. Free-rinsing, leaves no dulling film.

11901705 14942 35 oz. 9/cs.

Quik-Solv Spray Cleaner

Industrial strength solvent-based detergent cleaner. Removes tough soils and stains as well as baked on grease. No mixing required. Just spray and wipe. Versatile enough to use for most spot cleaning jobs. Safe for all hard surfaces. All cleaning agents are biodegradable.

11904164 74164 32 oz. 12/cs.



All Purpose Cleaners



A. AJAX® (CONT.) COLGATE-PALMOLIVE

Scouring Creme Cleaner

No harsh abrasives. Fresh lemon scent. Perfect for modern surfaces; polishes and destains to keep surfaces looking new. Effective on vertical surfaces. DfE approved formula.

11901700 04941 24½ oz. 9/cs.



B. FABULOSO® ALL PURPOSE CLEANERS COLGATE-PALMOLIVE

Cleans and leaves a long-lasting fresh scent. Effective for a wide variety of cleaning applications. Advanced technology formula penetrates deep into surface to capture grease and soils. Neutral pH makes product safe for people and surfaces. No alkaline builder to leave a residue. No-rinsing step needed in floor cleaning applications. All cleaning agents are biodegradable. Bilingual labeling. DfE approved formula.

11900015 53046 32 oz., Lavender 9/cs.

11903017 53017 32 oz., Lavender 12/cs.

11903024 53032 56 oz., Lavender 6/cs.

11904307 04307 1 gal., Lavender 4/cs.

11904373 04373 1 gal., Ocean Cool 4/cs.



C. MURPHY® MULTI-USE WOOD CLEANER W/ORANGE OIL COLGATE-PALMOLIVE

Convenient ready-to-use all purpose formula with special cleaning agents to remove finger marks, crayon and grease. Pure vegetable oil soap; no dulling residue. Cleans finished wood and hard surfaces. Contains natural orange oil.

11901030 01030 22 oz., Trigger Sprayer 12/cs.



D. SOFT SCRUB® LEMON CLEANSER DIAL

Mild abrasive and versatile multipurpose cleanser that is tough on grease, dirt and soap scum without damaging surfaces. Fresh lemon scent.

12805020 15020 38 oz. 6/cs.



E. EASY PAKS® ALL PURPOSE CLEANER DIVERSEY

Concentrated powdered compound quickly effervesces in water to produce a cleaning dilution that can be varied to meet your needs. Specially-formulated to loosen and remove stubborn soils. Can be used on stainless steel, chrome, porcelain, ceramic tile, quarry tile, terrazzo, linoleum, marble, concrete, painted surfaces and vinyl. NSF C1 Registered.

15200154 90651 (90) 1/2 oz. 2/90/cs.



F. FANTASTIK® DIVERSEY

All Purpose Cleaners

Ready-to-use for fast, effective cleaning on most washable surfaces. Removes stubborn stains including grease, scuff marks, pencil and crayon marks, smoke film and fingerprints. No rinsing required. Can be used on a variety of surfaces including exhaust fans, stove hoods, walls, ceramic tile, porcelain fixtures, bathtubs, plastic upholstery, cabinets, stainless steel, metal awnings, painted woodwork, chrome, appliances, sinks and showers.

15200046 94368 32 oz., Trigger Sprayer - Professional 12/cs.

15200504 2900504 32 oz., Capped Trigger Bottle 12/cs.

15200047 94369 1 gal. 4/cs.

15200045 94366 5 gal., Bag-in-Box 1/ea.

Orange Action All Purpose Cleaner

Tough cleaning action with pure orange oil. Cuts through tough grease and grime without leaving a smeary residue. Deodorizes multi-surfaces. Use on appliances, stainless steel, chrome, countertops, sinks, cabinets, ceramic tile, floors, basins, tubs, showers, fiberglass and porcelain surfaces.

15200187 CB182628 32 oz., Trigger Sprayer 12/cs.



G. JANITOR IN A DRUM® HEAVY-DUTY CLEANER DIVERSEY

A heavy-duty hard surface cleaner containing a superior grease suspension formula that provides the cleaning power needed on tough commercial kitchen floors and emulsifies grease for easy pick-up without harsh alkalis or solvents. An ideal all purpose cleaner to use on most washable surfaces and may be used on aluminum, painted surfaces, rubber, and vinyl. It can be used with a pressure sprayer, steam cleaner, automatic floor scrubber, mop, sponge, or brush. Goes to work immediately to remove soils and stains, scuff marks, dirt, grease, smoke film, and most food stains.

15200143 94365 1 gal. 4/cs.



All Purpose Cleaners



A. MR. MUSCLE® CHLORINATED CLEANSER DIVERSEY

Cleans and deodorizes using mild abrasives like those found in more expensive soft liquid cleansers. Easily removes stains, corrosion and most soils from surfaces like tile, porcelain, metal, enamel and terrazzo.

15200032 91210 21 oz. 24/cs.

B. SPEEDBALL® HEAVY-DUTY SPRAY CLEANERS DIVERSEY

Conquers tough soils. Removes grease, oil encrusted soil, tire marks, ink, smoke, carbon film, graffiti, heel marks and more. Ready-to-use convenience.

57080088 4043320 1 qt., Original Scent 12/cs.
57083120 4043110 1 gal., Original Scent 4/cs.

C. SPITFIRE™ POWER CLEANER DIVERSEY

The super-strength formula eliminates grease, petroleum and food oils. This powerful cleaner works on the toughest dirt, grime or stains on a wide variety of surfaces and soils. Lightly scented and pleasant to use, the no-rinse formula leaves no residue.

15207961 3702 32 oz., RTU 12/cs.

D. STRIDE CITRUS® ALL PURPOSE CLEANERS DIVERSEY

Use as an all purpose neutral cleaner for everyday floor cleaning and light-duty spray and wipe cleaning. Non-dulling and rinse-free. Pleasant citrus fragrance.

15203904 3904 1 gal., Conc. 1:32-1:64 4/cs.
15203906 3906 5 gal. Envirobox™, Conc. 1:32-1:64 1/ea.

E. STRIDE® ALL PURPOSE CLEANERS DIVERSEY

Fresh floral fragrance. Use as an all purpose neutral cleaner for everyday floor cleaning and light-duty spray and wipe cleaning.

15204689 4689 1 gal., 1:32 - 1:64 4/cs.
15207107 4693 5 gal. Envirobox™ 1/ea.

F. WHISTLE® ALL PURPOSE CLEANERS DIVERSEY

Special formula for heavy-duty cleaning. Use on washable hard surfaces, chrome appliances and fixtures. No rinsing or streaking. No phosphates. Trilingual packaging. Multi-surface: Use on walls, floors, woodwork, cabinets, counters, ceramic tile, stainless steel, chrome, tiles and more. Concentrated for use at various dilution rates depending on soil load.

15200083 91218 1 gal., Concentrate 4/cs.

Special ammoniated formula for heavy-duty cleaning. Use on washable hard surfaces, chrome appliances, fixtures. No rinsing or streaking. No phosphates. Trilingual packaging. Multi-surface: use on walls, floors, woodwork, cabinets, counters, ceramic tile, stainless steel, chrome, tiles and more. NSF C1 Registered.

15200085 91249 32 oz., Trigger Sprayer 12/cs.

G. WINDEX® DIVERSEY

Multi-Surface Antibacterial Cleaner

Versatile cleaner effectively kills 99.9% of bacteria, removes grease and cleans surfaces, including glass, to a streak-free shine. Sanitizes hard, nonporous surfaces in 10 seconds. Disinfects hard, nonporous surfaces in five minutes. Wherever food contact is likely, rinse surface with tap water after use. See label for complete list of organisms and directions on how to sanitize and disinfect.

15200380 CB701380 32 oz., Trigger Sprayer 8/cs.

Multi-Surface Vinegar

Cleans almost anything to a streak-free shine. Versatile for use on windows, mirrors, countertops, appliances, kitchen and bathroom surfaces, chrome and even car interiors. Non-aerosol, ammonia-free formula has no harsh vinegar smell and leaves a fresh, clean scent.

15200384 CB701397 32 oz. 8/cs.

H. MR. CLEAN® ALL PURPOSE CLEANER PROCTER & GAMBLE

Versatile cleaner for any hard, washable surface. Leaves no dulling streaks.

16905306 31501 28 oz., Lemon Scent 12/cs.

All Purpose Cleaners



A. SPIC AND SPAN® PROCTER & GAMBLE

Disinfecting All Purpose & Glass Cleaners

Powerful 3-in-1 formula helps improve cleaning productivity and simplifies cleaning while saves time in one easy step. Spic and Span replaces a glass cleaner, an all-purpose cleaner, and a disinfecting cleaner. Cleans stainless steel. Hospital-grade disinfectant, bactericide, fungicide, virucide and deodorizer. EPA Registration No. 6836-245-3573. Kills Influenza A2 Hong Kong, Respiratory Syncytial Virus (RSV), Vaccinia, Herpes Simplex Type 1, Herpes Simplex Type 2, HIV-1.

16901240	31240	32 oz., RTU	8/cs.
16907008	02030	64 oz., 10X	3/cs.
16909680	32538	1 gal., 15X	2/cs.
16908196	60319	1 gal., RTU	3/cs.

Powder All Purpose Cleaner

A versatile, heavy-duty all purpose cleaner whose power is released in water. Works great on tracked-in dirt. Non-phosphate. Use diluted (1 cup per 4 gallons) for non-waxed floors, walls, tubs and tiles. Use concentrated (2 cups per 4 gallon) and add ammonia for stripping wax and other tough jobs.

16900139	31973	27 oz.	12/cs.
----------	-------	--------	--------

B. LYSOL® RECKITT BENCKISER

Brand All Purpose Cleaner 4-in-1

Versatile all purpose cleaner that cleans, disinfects and deodorizes. Cuts through tough grease and grime. Convenient, ready-to-use trigger spray. Kills 99.9% of bacteria in 30 seconds on hard, non-porous surfaces.

58345352	75352	32 oz., Lemon Breeze®	12/cs.
----------	-------	-----------------------	--------

Brand II All Purpose Cleaner 4-in-1

Versatile all purpose cleaner with 4-in-1 action. Kills 99.9% germs (when used as directed), cuts grease, removes soap scum and deodorizes. Convenient, ready-to-use trigger spray.

58348031	80313	32 oz., Pacific Fresh®	12/cs.
----------	-------	------------------------	--------

C. PROFESSIONAL LYSOL® RECKITT BENCKISER

Antibacterial All Purpose Cleaner

Controls mold and mildew, counteracts odors. Kills Salmonella Choleraesuis, E. coli, Staph and other bacteria. Cleaner and degreaser for food and non-food areas. For light-duty cleaning and sanitizing, makes up to 128 gallons. For heavy-duty cleaning and disinfecting, makes up to 64 gallons. EPA Registration No. 675-36.

58344392	74392	1 gal.	4/cs.
----------	-------	--------	-------

Antibacterial Kitchen Cleaner

Cuts through tough kitchen grease and grime. Kills harmful bacteria including Salmonella, E. coli, Listeria monocytogenes, Staph and HIV-1 (AIDS virus). No harsh chemicals, contains no abrasives or bleach. Ready-to-use, citrus scent formula. EPA Registration No: 777-66-675.

58347441	74411	32 oz., Trigger Sprayer	12/cs.
----------	-------	-------------------------	--------

D. SIMPLE GREEN® SIMPLE GREEN

All Purpose Cleaner

The original non-toxic, biodegradable, concentrated formula with a lemon scent. The concentrated formula can be diluted with water to remove grease, soap scum, stains and more from any washable, indoor or outdoor surface.

73434002	14002	24 oz., Trigger Sprayer	12/cs.
----------	-------	-------------------------	--------

All Purpose Cleaners/Degreasers

Versatile all purpose cleaner is non-toxic and biodegradable, without harmful bleach or ammonia. Concentrate.

73433012	13012	24 oz., Trigger Sprayer	12/cs.
73433013	13013	32 oz., Trigger Sprayer, Consumer Brand	12/cs.
73433014	13014	67 oz., Trigger Sprayer	6/cs.
73433005	13005	1 gal.	6/cs.
73433016	13006	5 gal.	1/ea.
73433008	13008	55 gal.	1/ea.

Clean Building™ All Purpose Cleaner Concentrate

Formulated for cleaning all water-safe hard surfaces. Concentrate offers economical dilution, and with no fragrance or volatile organic ingredients, it doesn't adversely impact indoor air quality. Green color. Non-toxic, biodegradable, non-caustic, and non-flammable. Makes 65 gallons of ready-to-use cleaner.

73431001	11001	1 gal., Green Seal®	2/cs.
----------	-------	---------------------	-------



All Purpose Cleaners



CHEMICALS

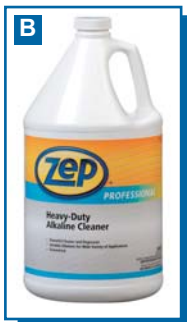

A. FOAMING CITRUS CLEANER ZEP

Rich foaming, multi-purpose citrus aerosol safely cleans a wide variety of hard surfaces. Applies as thick foam to ensure proper coverage. Clings to vertical surfaces for enhanced performance and prolonged contact time. Leaves a fresh citrus scent.

75070099 R06801 24 oz. 12/cs.

B. HEAVY-DUTY ALKALINE CLEANER ZEP

All purpose cleaner and degreaser uses a blend of detergents and a water soluble solvent to remove tough soils. Compatible with a broad range of dilutions to accommodate any cleaning application. May be used in pressure washer applications or hand steaming.

75070125 R08524 1 gal. 4/cs.
75070126 R08535 5 gal. 1/ea.

C. HEAVY-DUTY HIGH ALKALINE CLEANER ZEP

Concentrated, multi-purpose, low-foam, powerfully alkaline, cleaner and degreaser for use in extra heavy-duty industrial cleaning applications. May be applied with mop, brush, or pressure washer. Caustic formulation acts fast on most industrial cleaning applications.

75070127 R08624 1 gal. 4/cs.
75070128 R08635 5 gal. 1/ea.

D. MULTI-SURFACE CLEANER ZEP

Heavy-duty aerosol non-streaking cleaner for glass and other hard surfaces. Premium product for cleaning any surface not normally harmed by water. Grease, surface smears, fingerprints, and other soils are easily removed by simply spraying and wiping away.

75070097 R06601 20 oz. 12/cs.

E. Z-VERDANT RTU CLEANER ZEP

Environmentally preferred, easy-to-use cleaner for use on multiple surfaces and tough soils. May be used on any surface not harmed by water. Easily breaks down common soils making it an excellent everyday cleaner. Contains no harmful solvents or harsh chemicals.

75070100 R06901 1 qt. 12/cs.
75070101 R06935 5 gal. 1/ea.

ALL PURPOSE CLEANERS - BLEACH

F. PRIME SOURCE® OXYGEN BLEACH CLEANSER PRIME SOURCE®

Calcite-based, non-chlorinated formula effectively cleans porcelain, ceramic tile, stainless steel fixtures and aluminum.

75004015 75004015 21 oz. 24/cs.

G. AJAX® COLGATE-PALMOLIVE

Heavy-Duty Oxygen Bleach Cleanser

Non-chlorinated, economical cleanser for durable surfaces. The economical choice for general soils where chlorine or ammonia odors are undesirable.

11904278 14278 21 oz. 24/cs.

Oxygen Bleach Cleanser

Calcite-based, non-chlorinated formula. For use on porcelain, ceramic tile, stainless steel fixtures, and aluminum. Works well in tough cleaning situations where chlorine is undesirable.

11901460 04275 14 oz., Silica 48/cs.

H. SOFT SCRUB® COMMERCIAL CLEANSER W/BLEACH DIAL

Soft Scrub® cleanser has superior surface safety, attacks grease and rinses clean. Formulated to protect surfaces and to minimize work and residue.

12805519 15519 36 oz. 6/cs.

I. FANTASTIK® ALL PURPOSE CLEANER W/BLEACH DIVERSEY

The powerful surfactants in the formula will cut through kitchen grease and restroom soap scum. The bleach will remove food stains from countertops and kitchen surfaces and mold and mildew stains in the restrooms. Use throughout kitchen and restrooms. Fresh, clean scent.

15200325 4471141 32 oz., Trigger Sprayer 12/cs.

All Purpose Cleaners/Freezer Cleaners



A. COMET® PROCTER & GAMBLE

Cleaner w/Bleach

Cuts through tough grease and bleaches many troublesome food stains. Helps remove soap scum, hard water stains, and body soils in sinks, toilets and urinals. Attacks and bleaches mold and mildew stains with little to no scrubbing.

16907017	07017	32 oz., RTU	8/cs.
16902291	02291	1 gal., RTU	3/cs.

Powder Disinfectant Cleanser

Bleaches tough stains and disinfects as it cleans. Abrasive powder cleanser with chlorine bleach for scouring tough stains on toilet bowls, wall tiles, tubs, sinks, chrome, stainless steel, stove tops and pots and pans. Its gentle abrasives can be used on fiberglass tubs and showers, imitation marble and similar hard plastic surfaces. Effective against staphylococcus, salmonella and pseudomonas.

16908447	08447	21 oz., EPA	24/cs.
16902987	32987	21 oz.	24/cs.



B. PROFESSIONAL LYSOL® ALL PURPOSE CLEANER PLUS BLEACH RECKITT BENCKISER

All purpose cleaner contains a combination of detergents and bleach to cut through tough soils, food grease and soap scum. Specially formulated for both restroom and food area surfaces. Whitens and removes stubborn mold and mildew as well as food stains. Authorized under 1998 USDA standards for use in food preparation areas (Category A-1).

58344532	94532	32 oz., Trigger Sprayer	12/cs.
----------	-------	-------------------------	--------



ALL PURPOSE CLEANERS - PINE

C. PRIME SOURCE® ECONO PINE CLEANER PRIME SOURCE®

Provides economical cleaning. Rinse-free. Made from pure pine oil.

75004009	75004009	1 gal.	4/cs.
----------	----------	--------	-------



D. PRIME SOURCE® REFRESH PINE DEODORANT CLEANER PRIME SOURCE®

All purpose cleaner and deodorant that contains pine oil to provide outstanding deodorizing power.

75004017	75004017	1 gal.	4/cs.
75004018	75004018	5 gal.	1/ea.



E. ALL PURPOSE PINE CLEANER CARROLL

Formulated with emulsifiable pine oil. Effective cleaner with outstanding deodorizing power. Concentrated formula safe for use on most washable surfaces. Excellent pine fragrance.

30010143	34028	1 gal.	4/cs.
----------	-------	--------	-------



F. PINE-SOL® ALL PURPOSE CLEANER CLOROX

Cleans and deodorizes floors, countertops, tile, sinks, garbage cans, and more. Excellent grease and soil removal. Removes dirt from hard surfaces. Deodorizes with a fresh pine scent. EPA registered disinfectant.

38380145	40145	15 oz.	12/cs.
38380174	40174	28 oz.	12/cs.
38380125	40125	48 oz.	8/cs.
38381773	41773	60 oz.	6/cs.
38385418	35418	144 oz.	3/cs.



G. AJAX® PINE FOREST CLEANER COLGATE-PALMOLIVE

Pine-scented cleaner for general cleaning and deodorizing hard washable surfaces. Dual detergent system for greasy and particulate soils. All cleaning agents are biodegradable.

11908205	04209	1 gal.	4/cs.
----------	-------	--------	-------



FREEZER CLEANERS

H. PRIME SOURCE® FREEZE CLEAN FREEZER CLEANER PRIME SOURCE®

Ready-to-use cleaner with anti-freeze properties. Use to remove soils in sub-freezing conditions.

75004007	75004007	1 gal.	4/cs.
----------	----------	--------	-------



Freezer Cleaners/Degreasers



A. JOHNSON® FREEZER FLOOR CLEANER DIVERSEY

Low temperature formula keeps freezer surfaces and floors clean without shutdown. Works down to -5°F.

15208130 48030 1 gal. 4/cs.

DEGREASERS

B. PREMIUM PLUS ULTRA FOAMY MEATROOM DEGREASER PRIME SOURCE®

Ultra-foamy, non-butyl degreaser is perfect for use in supermarkets and the foodservice and processing industry. Non-flammable, biodegradable, rinses away free for easy cleaning.

75004580 75004580 1 gal. 4/cs.
75004581 75004581 5 gal. 1/ea.

C. PRIME SOURCE® BREAKDOWN HIGH FOAM DEGREASER PRIME SOURCE®

High foaming degreaser effective in cleaning animal fat, blood stains and greasy soils from a variety of food tools and equipment. Excellent for foodservice and food processing customers.

75004134 75004134 1 gal. 4/cs.
75004135 75004135 5 gal. 1/ea.
75004133 75004133 55 gal. 1/ea.

D. PRIME SOURCE® CITRA KLEEN CLEANER/DEGREASER PRIME SOURCE®

Concentrated, water-based, non-butyl degreaser that rapidly dissolves grease, dirt and soils. Citra Kleen's mild citrus scent enables this product to be used in enclosed or confined areas.

75004140 75004140 1 gal. 4/cs.
76008508 76008508 3.78 L 4/cs.
76008509 76008509 18.9 L 1/ea.

E. PRIME SOURCE® GREEN MULTI-PURPOSE CLEANER DEGREASER PRIME SOURCE®

Water-based, environmentally friendly green cleaner.

76008502 76008502 3.78 L 4/cs.

F. PRIME SOURCE® ORANGE SOLVENT NATURAL CITRUS DEGREASER PRIME SOURCE®

Powerful, d-limonene-based degreaser that effectively removes grease, oils, food soils, adhesives, inks, rubber marks, organic and inorganic soils.

75004136 75004136 32 oz. 12/cs.
750041371 75004137 1 gal. 1/ea.
75004137 75004137 1 gal. 4/cs.

G. PRIME SOURCE® POWER SPRAY RTU DEGREASER/CLEANER PRIME SOURCE®

Ready-to-use spray and wipe degreaser that effectively removes black heel marks, crayon, ink, adhesives and other stubborn soils.

75004144 75004144 32 oz., RTU 12/cs.

H. PRIME SOURCE® TORNADO RTU NON-BUTYL CLEANER/DEGREASER PRIME SOURCE®

Ready-to-use, non-butyl, d-limonene cleaner/degreaser that penetrates and removes heavy organic and inorganic soils from virtually any washable surface.

75004142 75004142 32 oz., RTU 12/cs.

I. PRIME SOURCE® TUF DUTY HEAVY-DUTY CLEANER/DEGREASER PRIME SOURCE®

Highly concentrated for the removal of industrial soils, oils and greases, carbon deposits and ink.

75004130 75004130 1 gal. 4/cs.
76008539 76008539 3.78 L 4/cs.
76008540 76008540 18.9 L 1/ea.
75004131 75004131 5 gal. 1/ea.
75004132 75004132 55 gal. 1/ea.

Degreasers



A. DEVOUR MEATROOM FOAMING DEGREASER CARROLL

Alkaline built, non-butyl, foaming cleaner/degreaser. Excellent for supermarket, food service and food processing applications. Non-flammable, biodegradable, free-rinsing. No fragrance added. USDA A1.

30010454 13628 1 gal. 4/cs.



B. DG-90® EMULSIFIABLE DEGREASER CARROLL

Formulated with natural citrus solvents and emulsifiers for a 100% active solution for heavy cleaning and degreasing. Safe for use on virtually every hard surface or fabric to remove heavy petroleum soils, food soils, rubber marks, adhesives, inks, etc. USDA C1.

30010151 33128 1 gal. 4/cs.



C. DOOR KNOCKER® CLEANER/DEGREASER CARROLL

Water-based solvent, non-butyl degreaser. For industrial, institutional and commercial settings. Concentrated, moderate foam, free-rinsing. Citrus fragrance. USDA A4, A8.

30010164 16628 1 gal. 4/cs.



D. ORANGE ALL CLEANER/DEGREASER CARROLL

D-limonene formula with excellent emulsifying and dissolving ability. No petroleum solvents, no flash back odor, no hydrocarbons, no ammonia or bleach. Quickly penetrates and emulsifies a wide range of tough soils. Deodorizing citrus fragrance.

30015828 15828 1 gal. 4/cs.



E. SPRAY SOLVS IT! MULTIPURPOSE CLEANER CARROLL

Water-based solvent rapidly dissolves grease, dirt and other soils. Product can be used on most surfaces, except glass. Clear blue; fresh peppermint fragrance; USDA A8, C1.

30010138 12223 1 qt. 12/cs.

30010159 11528 1 gal. 4/cs.



F. FORMULA 409® CLOROX

Cleaners/Degreasers/Disinfectants

Quickly removes grease, grime, food stains and other oil-based dirt. Powerful ready-to-use formula. EPA Registered disinfectant and sanitizer for non-food contact surfaces.

38385306 35306 32 oz., Trigger Sprayer 12/cs.

38385300 35300 1 gal., Refill 4/cs.

Heavy-Duty Degreaser

Concentrated formula for the heavy-duty degreasing tasks.

38385296 35296 32 oz., Trigger Sprayer 9/cs.

38380018 00014 1 gal. 4/cs.



G. AJAX® SOFT CLEANSER COLGATE-PALMOLIVE

Contains chlorinating agents, detergents and grease cutters. Quickly removes greasy stains and soils. Mild calcite abrasives gently polish stains away safely.

11904290 14290 21 oz. 30/cs.



H. AJAX EXPERT® COLGATE-PALMOLIVE

Foaming Cleaner/Degreaser

Neutral pH formula, foaming degreaser. Fragrance-free for cleaning food contact surfaces. Effective on all hard surfaces for meat rooms, food processing plants, commercial kitchens.

11904950 04950 1 gal. 4/cs.

Heavy-Duty Degreaser/Concrete Cleaner

Ready-to-use, d-limonene-based spray and wipe cleaner for heavy-duty jobs. Cuts grease and soils without harsh chemicals. Pleasant citrus fragrance. Contains biodegradable cleaning agents.

11904166 04166 1 gal., Refill 4/cs.

High Performance Degreaser

Unique chemical action loosens and dissolves grease and soils. Patented formulation using microemulsion technology. Effective on heavy grease and soils on floors, walls, grills, ceramic tile, vent hoods and more. Contains biodegradable cleaning agents.

11904940 04940 1 gal. 4/cs.



I. BREAK-UP™ FOAMING GREASE RELEASE CLEANER DIVERSEY

Specially formulated for removal of protein, fats and food residues. Effective on all hard surfaces in meat rooms and other food preparation and service areas. Recommended for supermarkets, restaurants, institutional kitchens and food processing plants. Carries USDA A-1 rating.

15204495 4495 1 gal. 4/cs.



Degreasers



A. EASY PAKS® HEAVY-DUTY CLEANER/DEGREASER DIVERSEY

Specially designed for tough floor degreasing and general purpose spray and wipe cleaning. For floors and other hard surfaces as well as stainless steel, linoleum, vinyl, asphalt, ceramic tile, quarry tile, terrazzo, marble, concrete, painted surfaces and vinyl.

15200184 90682 (36) 1½ oz. Packets 72/cs.



B. PRIME-CUT ULTRA™ FOODSERVICE DEGREASER DIVERSEY

Super concentrated, non-corrosive, degreaser for foodservice and food preparation surfaces. J-Pak bag.

15204296 4296 2½ gal. 1/ea.



C. WHISTLE® DEGREASER/DISINFECTANT TB DIVERSEY

For use as a cleaner and disinfectant in hospitals, nursing homes, schools and hotels. Tuberculocidal, fungicidal, virucidal, kills Hepatitis B and HIV. Formulated to disinfect hard, nonporous surfaces such as walls, sink tops and tables. Deodorizes areas which generally are hard to keep fresh smelling. Colorless with a lemon scent.

15200084 91330 32 oz. 6/cs.



D. DAWN® PROCTER & GAMBLE

Heavy-Duty Degreaser

Full-strength cleaning for tough, greasy soils. Non-corrosive to hands. Solvent-based degreaser for the full strength cleaning of extra tough, greasy build-up on surfaces like range hoods, ovens, walls behind equipment, floors, drive-thrus and fuel islands.

16904852 84957766 1 gal. 3/cs.

Power Dissolver

Specially formulated to dissolve burnt-on, baked-on, carbonized grease and foods from the bottoms and outsides of pots, pans and baking sheets, eliminating the need to scour. Uses a patented solvent-based formula to quickly penetrate and dissolve grease, making it simple to wipe grease away. Also an effective, safe-to-use oven cleaner.

16901983 01983 32 oz. 6/cs.



E. SPIC AND SPAN® PROCTER & GAMBLE

HEAVY-DUTY DEGREASERS

Full strength cleaning for tough, greasy build-up on range hoods, ovens and walls. Safe for use on food contact surfaces. Non-caustic, non-flammable and non-corrosive means employee safety.

16908153 02674 1/2 gal. 5/cs.

16900031 07002 1 gal. 3/cs.



F. EASY-OFF® HEAVY-DUTY RECKITT BENCKISER

CLEANER/DEGREASER

Specially formulated to cut through kitchen grease, fat, oil and petroleum. Non-flammable formula easily removes tough, oily soil from a wide variety of surfaces. Controlled suds for easy rinsing. Can be used in pressure washers and automatic scrubbers. Concentrated formula is economical to use. USDA A-1.

58344383 74383 1 gal. 4/cs.

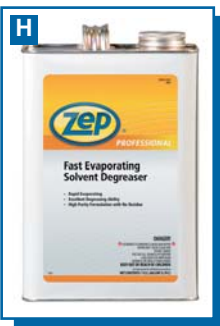

G. CRYSTAL SIMPLE GREEN® INDUSTRIAL SIMPLE GREEN

STRENGTH CLEANERS/DEGREASERS

Safe, effective and powerful all purpose cleaner/degreaser for critical cleaning applications that demand a fragrance-free solution. Non-toxic, non-abrasive and no caustic fumes. Exempt from OSHA and EPA special handling and personal protection requirements. Approved for use in federally inspected meat and poultry plants, and meets Montreal Protocol Guidelines and FDA requirements for cleaning cosmetics, medical and pharmaceutical environments. Excellent for use in parts washers, pressure washers, floor scrubbers and other mechanized applicators.

73439010 19010 20 oz., Foaming Aerosol 12/cs.

73439128 19128 1 gal. 6/cs.

73439055 19055 55 gal. 1/ea.



H. FAST EVAPORATING SOLVENT DEGREASERS ZEP

Extra heavy-duty industrial degreaser designed for use where fast evaporation and no residue are desirable. Removes oil deposits, grease and tar from moving parts and mechanical equipment.

75070107 R07524 1 gal. 4/cs.

75070108 R07535 5 gal. 1/ea.

Degreasers/Sanitizers



A. FOAMING HEAVY-DUTY DEGREASER ZEP

Industrial strength aerosol cleaner and degreaser strong enough for the toughest cleaning jobs. For use on vinyl, ceramic, Formica, porcelain, stainless steel, and other hard surfaces.
75070098 R06701 20 oz. 12/cs.



B. HEAVY-DUTY BUTYL DEGREASER ZEP

Industrial strength butyl formulation cuts through greases, oils, and other tough soils. Low foaming, free rinsing, biodegradable formula may be applied with a mop or pressure washer. Broad dilution range for a variety of applications.

75070131 R08824 1 gal. 4/cs.
75070132 R08835 5 gal. 1/ea.

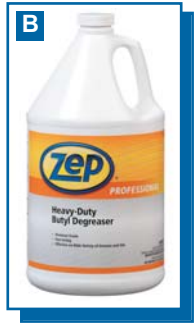

C. HEAVY-DUTY CITRUS DEGREASER ZEP

Organic, non-petroleum cleaner and degreaser with d-limonene and soy for use on equipment and machinery. Utilizes renewable resources to cut through tough grease.

75070111 R07701 1 qt. 12/cs.
75070112 R07724 1 gal. 4/cs.



D. SELF-EMULSIFYING SOLVENT DEGREASER ZEP

Concentrated, rinseable, general-purpose solvent cleaner. Composed of grease fighting solvents and emulsifiers. Works well on both heavy and light cleaning such as engines, machinery and oil soaked floors. May be diluted before use. Low odor formulation suitable for indoor use.

75070109 R07624 1 gal. 4/cs.
75070110 R07635 5 gal. 1/ea.

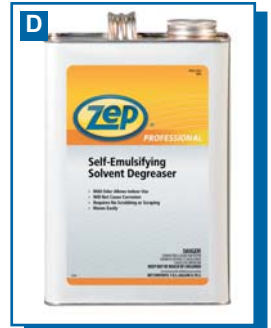

E. VOC COMPLIANT SOLVENT DEGREASER ZEP

Environmentally preferred, solvent-based degreaser with d-limonene for use where a water-free formula is preferred. Meets all CA-CARB and OTC requirements.

75070113 R07824 1 gal. 4/cs.
75070114 R07835 5 gal. 1/ea.

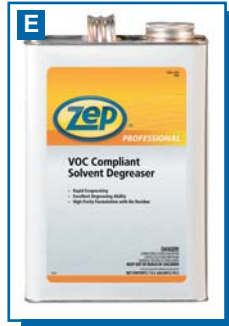

SANITIZERS

F. CLOROX® ANYWHERE® HARD SURFACE™ CLOROX

Daily Sanitizing Spray

A convenient way to sanitize. It's gentle enough to use on hard, non-porous surfaces around kids and food, yet powerful enough to kill 99.9% of common household bacteria, E. coli, Salmonella, Staphylococcus (Staph) and Streptococcus (Strep.). Plus, since it has no harsh fumes and leaves no harmful residue, it needs no wiping or rinsing.

38381683 01683 22 oz. 9/cs.

Sanitizing Spray

Sanitizing spray delivers the sanitizing power of bleach in a ready-to-use, stable formula. Sanitizes a wide variety of hard, nonporous surfaces using a revolutionary pH-balanced formula that is color-safe and mild enough to use without gloves.

38381698 01698 32 oz. 12/cs.



G. AJAX® CUTTING BOARD DESTAINER COLGATE-PALMOLIVE

Ready-to-use cutting board destainer. Cleans cutting boards and chopping blocks. Bleach formula.

11904180 04179 1 gal. 4/cs.



H. SANI-SURE® DIVERSEY

Multi Surface Sanitizer

For use on both food and non-food contact surfaces. Use on tabletops, countertops, floors, walls, sinks, splash backs and trays. For use on food processing/preparation equipment. Trichloromelamine (TCM) formula provides 125 ppm available chlorine to be used during each eight hour shift.

15200101 90670 1/8 oz. Packets 100/cs.

Soft-Serve Sanitizer

Highly-concentrated formula is ideal for shake, slush, soft-serve or yogurt machines. No-foaming formula. Pre-measured pouch designed to help control costs, product waste and inventory. Excellent for the removal of fat particles; helps dissolve milkstone and protein.

15200153 90234 1 oz. Packets 100/cs.



Sanitizers/Vandal/Gum/Ammoniated Glass Cleaners



CHEMICALS



A. PROFESSIONAL LYSOL® NO RINSE SANITIZER **RECKITT BENCKISER**
 Meets federal food code requirements as a no rinse sanitizer. Perfect for three-bin sink and clean-in-place applications. Can also be used to disinfect and deodorize. Economical, concentrated formula makes up to 512 gallons. Controls algae in swimming pools and industrial non-potable water supplies. EPA Registration No: 675-30.
 58340010 74389 1 gal. 4/cs.

VANDAL/GRAFFITI/GUM REMOVERS



B. PRIME SOURCE® CHIP OFF GUM & WAX REMOVER **PRIME SOURCE®**
 Spray on and chip off. Use on carpets, upholstery, wood, vinyl or cloth.
 76000771 76000771 184g 12/cs.
 75004571 75004571 7 oz. 12/cs.

C. PRIME SOURCE® GRAFFITI VANDAL MARK REMOVER **PRIME SOURCE®**
 Powerful cleaning action with clean, fresh fragrance. Use on wood, metal and painted products.
 75004570 75004570 16 oz. 12/cs.
 76000770 76000770 511 g 12/cs.

D. PRE-MOISTENED GRAFFITI REMOVER TOWELS **ZEP**
 Heavy-duty, dual surfaced towels with powerful solvent action for quick removal of paint and ink from boats, vehicles, phone booths, glass, tile, and most uncoated metal surfaces.
 75070136 R09101 72 ct. 6/cs.



E. VANDAL MARK REMOVER **ZEP**
 Non-chlorinated formulation removes ink, crayon, pencil, adhesives, and grease from most painted surfaces, wood paneling, furniture, vinyl seats, wall coverings, Formica, fiberglass, and most plastics. For indoor and outdoor use.
 75070092 R06201 24 oz. 12/cs.

AMMONIATED GLASS CLEANERS



F. WINDA SHINE GLASS & UTILITY CLEANERS **CARROLL**
 Ready-to-use institutional glass cleaner with non-streaking and fast drying qualities. It is fortified with an undetectable splash of ammonia for an extra burst of grease cutting ability. Special anti-fogging ingredients help maintain surfaces in the presence of steam. Resist re-soiling and reduce dust-attracting static. Pleasant floral fragrance.
 30010129 14123 1 qt., Light Blue 12/cs.
 30010130 14128 1 gal., Light Blue 4/cs.

G. AJAX EXPERT® GLASS & MULTI-SURFACE CLEANERS **COLGATE-PALMOLIVE**
 Powerful ready-to-use formula requires no mixing and is convenient to use. Dual solvent system cuts through film and grease fast. Contains ammonia for extra cleaning power. Flash dries quickly without streaking or filming. Use on glass, countertops, mirrors and other hard washable surfaces. Contains biodegradable surfactants. Bilingual labeling. DfE approved formula.
 11901340 74199 32 oz., Trigger Attached 12/cs.
 11904174 04174 1 gal., RTU 4/cs.
 11901320 04195 1 gal., Concentrate 4/cs.



H. GLANCE® GLASS & MULTI-SURFACE CLEANER **DIVERSEY**
 Non-streaking, non-smearing, quick drying formula. Cleans and shines glass, mirrors, sinks, countertops, stainless steel, and many other washable surfaces.
 15204705 4705 32 oz., RTU 12/cs.

Ammoniated & Non-Ammoniated Glass Cleaners



A. WINDEX® DIVERSEY

Glass Cleaner with Ammonia-D® Super Concentrate

Cleans with Ammonia-D® for a streak-free shine. Loosens soil upon contact. Won't streak or leave a film. Also cleans chrome, stainless steel, Plexiglas®, mirrors, ceramic tile, enamel, plastic and other hard surfaces. Contains no phosphates. Six quarts per case; each quart yielding nine quarts of ready-to-use glass cleaner. Improved formula, 1:8 concentration; 13% more product per case (six additional ready-to-use quarts).

15200381 4601541 32 oz. 6/cs.

Glass & Surface Wipes

Pre-moistened wipes. Leaves a streak-free shine.

15200398 CB701106 28 ct. 252/cs.

Original Glass Cleaner

Cleans with Ammonia-D® for a streak-free shine. Loosens soil upon contact. Will not streak or leave a film. Also cleans chrome, stainless steel, Plexiglas®, mirrors, ceramic tile, enamel, plastic and other hard surfaces. Contains no phosphates.

15204123 CB001237 12 oz., Sprayer 12/cs.

Original Powerized Glass Cleaner w/Ammonia-D®

Cleans with Ammonia-D® for a streak-free shine. Loosens soil upon contact. Won't streak or leave a film. Also cleans chrome, stainless steel, Plexiglas®, mirrors, ceramic tile, enamel, plastic and other hard surfaces. Contains no phosphates. NSF C1 Registered.

15200161 90135 32 oz., Trigger Sprayer, Capped 12/cs.

15200082 90139 32 oz., Trigger Sprayer 12/cs.

15200081 90940 1 gal., Refill 4/cs.

15200007 90122 5 gal., Bag-in-Box 1/ea.

Powerized Foaming Glass Cleaner w/Ammonia-D®

Cleans with Ammonia-D® for a streak-free shine. Loosens soil upon contact. Will not streak or leave a film. Also cleans chrome, stainless steel, Plexiglas®, mirrors, ceramic tile, enamel, plastic and other hard surfaces. Contains no phosphates.

15200080 90129 567 g, Aerosol 12/cs.

B. PROFESSIONAL EASY-OFF® GLASS CLEANER RECKITT BENCKISER

Cuts the dirt and grease that causes streaking and spotting. Ideal for cleaning windows, countertops, mirrors, Plexiglas®, vinyl, chrome, and stainless steel. Specifically formulated to help prevent scratching by dissolving dirt particles. Enhanced ammoniated cleaning power.

58340101 00101 32 oz., Lemon Scent 12/cs.

C. GLASS CLEANER ZEP

Ready-to-use non-aerosol glass and surface cleaner used to clean any surface not damaged by water. Ammonia formulation removes fingerprints and smudges.

75070071 R04601 1 qt., RTU 12/cs.

75070072 R04624 1 gal., RTU 4/cs.

D. STREAK-FREE GLASS CLEANER ZEP

Ready-to-use, heavy-duty glass cleaner. Removes film, greasy fingerprints, bugs, lipstick and other soils.

75070143 ZU112032 32 oz. 12/cs.

NON-AMMONIATED GLASS CLEANERS

E. PRIME SOURCE® ECONO GLASS CLEANER PRIME SOURCE®

Economical, film-free cleaning. Controls dust accumulation. Safe, non-ammonia formula.

75004054 75004054 1 gal. 4/cs.

F. PRIME SOURCE® FILM-FREE GLASS CLEANERS PRIME SOURCE®

Heavy-duty, streak-free cleaning. Helps control dust and fingerprints. Non-ammonia; may be used on Plexiglas® surfaces.

75004049 75004049 19 oz. 12/cs.

760007671 76000767 539 g, Aerosol 1/ea.

76000767 76000767 539 g, Aerosol 12/cs.

75004050 75004050 1 qt. 12/cs.

76008546 76008546 946 mL, RTU 12/cs.

75004051 75004051 1 gal. 4/cs.

75004053 75004053 55 gal. 1/ea.



Non-Ammoniated Glass Cleaners



CHEMICALS



A. PRIME SOURCE® GLASS CLEANER PRIME SOURCE®

A concentrated, economical product that is effective on many difficult soils. Fast drying, streak-free formula, 1:8 dilution. Ideal for use on many hard surfaces. VOC and A.P.E. free.
76008538 76008538 3.78 L 4/cs.

B. ENVIROPATROL® GLASS & SURFACE CLEANER CARROLL

Use as a high performance glass and utility cleaner. It can be used as a spray and wipe glass cleaner or with a sponge and squeegee. Leaves no residues. Helps prevent resoiling. Use on Plexiglas®, windows, windshields, walls, countertops, cabinets, partitions, light fixtures, stainless steel, chrome, plastic, vinyl and other hard surfaces not harmed by water. Dilutes at 1 oz./gal. (1:128) for most applications. Green Seal® certified. Cold water effective.
30018228 18228 1 gal. Green Seal® 4/cs.

C. GLASS & SURFACE CLEANER CARROLL

An extra-strength, concentrated super-base intended to be diluted before use. Economically dilutable to 8 oz. per gallon of water for everyday cleaning of glass, mirrors and other hard surfaces.
30010133 18328 1 gal. 4/cs.

D. WINDA SHINE GLASS CLEANER CARROLL

Non-ammoniated, non-streaking foaming cleaner with fast drying and anti-fogging ingredients. Cleans and polishes glass and other hard surfaces. Pleasant fragrance.
30010034 80333 18½ oz. 12/cs.

E. FORMULA 409® GLASS & SURFACE CLEANER CLOROX

Simplify cleaning with one product for glass and other hard surfaces. Unique formula cuts dirt and grease without streaking.
38381270 35293 32 oz., Trigger Sprayer 9/cs.
38381269 03107 1 gal., Refill 4/cs.

F. GREEN WORKS® NATURAL GLASS & SURFACE CLEANER CLOROX

Clean without leaving anything behind; like harsh chemical fumes or residue. The natural way to get a streak-free clean. The plant and mineral-based ingredients work as well as traditional cleaners to cut through filmy residue. Safe on glass, mirrors, appliances, stainless steel and sealed granite. DfE approved formula. Ready-to-use.
38380459 00459 32 oz., Trigger Sprayer 12/cs.
38380460 00460 64 oz., Refill 6/cs.

G. GLASS PLUS® GLASS CLEANER DIVERSEY

Light-duty, non-ammoniated glass cleaner cuts through dirt, grease and grime on windows, mirrors, appliances and more.
15200049 94378 32 oz., Trigger Sprayer 12/cs.

H. NATURE'S SOURCE™ GLASS & SURFACE CLEANER DIVERSEY

Enjoy a natural kind of shine. This biodegradable cleaner keeps your countertops sparkling and windows streak-free naturally. Simply spray on, wipe and let the plant-based cleaners do their work. You'll enjoy the good feeling that comes from making a smart choice for you, your family and the planet. DfE approved formula.
15200442 CB701502 26 oz. 8/cs.

I. PROFESSIONAL EASY-OFF® AMMONIA-FREE GLASS CLEANER RECKITT BENCKISER

Concentrate makes up to 10 gallons of cleaning solution. Specifically formulated to help prevent scratching by dissolving dirt particles. Cleans mirrors, glass, display cases, telephones, appliances, tile, vinyl, laminated plastics. Leaves surface streak-free and film-free with no rinsing.
58345116 75116 1 gal. 4/cs.

J. SIMPLE GREEN® CLEAN BUILDING™ GLASS CLEANER CONCENTRATE SIMPLE GREEN

Streak and smear-free cleaning of glass and other reflective surfaces. Concentrate offers economical use dilution with no added fragrance or volatile organic ingredients that can adversely impact indoor air quality. Also safe to use on plastics. Non-toxic, biodegradable, non-caustic, and non-flammable formulation. Makes 31 gallons of ready-to-use cleaner.
73431201 11201 1 gal. 2/cs.

Non-Ammoniated Glass/Electronics/Furniture Polish



A. FOAMING GLASS CLEANER ZEP

Premium glass and mirror cleaning. Easy-to-use foam formulation. Convenient aerosol.
75070142 ZUFGC24 24 oz. 12/cs.



B. FOAMING GLASS & MIRROR CLEANER ZEP

Water-based solvents and fast-acting surfactants in a foaming aerosol glass and mirror cleaner dissolves tobacco residue, grease, and fingerprints. Can be used on any surface not harmed by water. Dries evenly and quickly to eliminate streaking. VOC compliant formulation.

75070073 R04701 24 oz. 12/cs.



C. GLASS CLEANER ZEP

Glass and all surface cleaner, effectively removes fingerprints, smudges, and other soils. May also be used as a light-duty cleaner on all water washable surfaces.

75070069 R04501 20 oz., Concentrate 12/cs.
75070070 R04535 5 gal., Concentrate 1/ea.



ELECTRONICS CLEANER

D. PLEDGE® ELECTRONICS CLEANER DIVERSEY

Anti-static formula Pledge® for computers, TVs, VCRs, stereos and other electronics.
15204323 94323 9 oz. 12/cs.

FURNITURE POLISH

E. FINESHINE FURNITURE POLISH AEROSOL PRIME SOURCE®

Blend on natural beeswax, carnauba wax, lemon oil and silicone leaves an even and deep gloss. Can safely be used on light or dark woods, plastic, marble and enameled surfaces.
75004066 75004066 18 oz. 12/cs.



F. PRIME SOURCE® GLAZE LEMON FURNITURE POLISH PRIME SOURCE®

A rich blend of natural beeswax and carnauba wax. Protects furniture against water marks, scratches and stains. May also be used on plastic and vinyl.
75004065 75004065 16 oz. 12/cs.
76000768 76000768 539 g 12/cs.

G. PLEDGE® DIVERSEY

Dust & Allergen Furniture Polish
 Anti-dust formula with Allergen Trappers® keep surfaces dust-free longer. Leaves no waxy build-up. No CFCs. Light, clean fragrance.
15204431 CB003971 12½ oz., Outdoor Fresh 12/cs.

Furniture Polish
 Leading name in wood care. Gentle cleansing conditioners remove fingerprints, smudges and dirt from wood furniture, cabinets, paneling, vinyl and leather. Shines, dusts, polishes and protects in one easy step. Lemon scent.
15209439 CB003995 12½ oz. 12/cs.
15200002 94430 18 oz. 6/cs.
15200166 CB121286 Wipes, 18 ct. 12/cs.

Multi-Surface Clean & Dust Wipes
 Multi-surface cleaner in the convenience and portion control of a wipe.
15204629 CB214629 25 ct. 300/cs.

Multi-Surface Cleaner
 Safely removes dust, fingerprints, smudges and smears from almost any surface. No-wax formula leaves no residue or build-up behind. Can be used on wood, glass, metal, electronics, plastic, mirrors, stainless steel, chrome, marble, granite, appliances, countertops, porcelain and more.
15200383 CB703123 16 oz. 6/cs.



H. SHINE-UP™ SPRAY FURNITURE CLEANER/POLISH DIVERSEY

Cleans and polishes furniture to a beautiful shine. Resists smears and fingerprints. White in color with a lemon scent.
15202788 4502788 17.7 oz., Aerosol 12/cs.



CHEMICALS

Furniture & Metal Polish



A. OLD ENGLISH® RECKITT BENCKISER

Furniture Polish

Cleans, shines and conditions without wax build-up. Contains conditioning Old English® oil to beautify and preserve wood. Helps prevent drying and cracking and protects against ordinary wear such as dust and fingerprints.

58344035 74035 12 1/2 oz., Lemon 12/cs.

Furniture Wipes

Quick and disposable with no residue build-up. Removes dust and smudge marks.

58345821 75821 25 ct., 7 1/2" x 10 1/2" 12/cs.

Lemon Furniture Oil

Gently moisturizes and protects wood without wax or silicones. Protects against drying and cracking, giving wood a rich, natural glow as it removes dirt and stains. Perfect for use on teak, oak, walnut, cherry, and all other natural woods including today's lighter veneers. Preserves and restores wood's natural beauty.

58341863 01863 8 oz. 12/cs.

Scratch Cover

Helps restore damaged wood surfaces. Hides unsightly scratches and nicks.

58345144 75144 8 oz., Dark Wood 6/cs.

58345462 75462 8 oz., Light Wood 6/cs.

B. LEMON FURNITURE POLISH ZEP

Removes dirt, fingerprints, grease marks, and smudges. Premium formulation contains lemon oil to condition wood and other hard surfaces. Polishes to a deep glossy shine. Contains no wax.

75070068 R04401 20 oz. 12/cs.

METAL POLISH

C. PRIME SOURCE® BRITE STAINLESS STEEL CLEANER PRIME SOURCE®

Water-based formulation cleans, shines and protects. Use on chrome, aluminum, brass and copper.

75004062 75004062 16 oz. 12/cs.

D. PRIME SOURCE® FLARE STAINLESS STEEL CLEANER PRIME SOURCE®

Oil-based formulation helps seal out corrosion. Restores original brilliance to stainless steel.

75004061 75004061 15 oz. 12/cs.

76000769 76000769 425 g 12/cs.

E. 3M™ STAINLESS STEEL CLEANER & POLISH 3M

Cleans and polishes stainless steel, chrome, aluminum and laminated plastic surfaces. Pleasant lime fragrance. Contains no petroleum distillates.

66551402 61500061322 21 oz. 12/cs.

F. BRITE BOY METAL POLISH CARROLL

The premier polish for brass, metal, aluminum, copper and silver. Unique formula stands alone in performance and ease of use. Cleans, restores and protects. Ready-to-use.

30019212 49211 16 oz. 12/cs.

30019232 49232 32 oz. 12/cs.

G. DEEP GLOSS® STAINLESS STEEL MAINTAINER DIVERSEY

Creamy, water-based spray cleans, polishes and protects stainless steel without abrasives. Resists smudges and water-marks.

15200590 4970590 16 oz. Aerosol 12/cs.

H. TWINKLE® STAINLESS STEEL CLEANER & POLISH DIVERSEY

Water-based formula removes grease, dirt, fingerprints, smudges and water marks from stainless steel, brass, aluminum and chrome. Leaves no residue or greasy film. Protects against re-soiling. Contains no CFCs. White in color with a lemon scent. NSF C1 Registered.

15200090 91224 17 oz. 12/cs.

Metal Polish/Oven & Grill Cleaners



A. BRASSO® MULTIPURPOSE METAL POLISH RECKITT BENCKISER

Wipes away tarnish on most metals, leaving a brilliant shine. Gently cleans and polishes brass, copper, chrome, stainless steel and pewter. Removes tarnish quickly and easily. Contains no harsh acids. Leaves a smooth, polished surface and a brilliant shine. Ideal to clean brass fixtures and banisters. Ready-to-use.

58346600 76523 8 oz. 8/cs.



B. PROFESSIONAL EASY-OFF® STAINLESS STEEL CLEANER & POLISH RECKITT BENCKISER

Resists fingerprints and watermarks. Contains no abrasives and will not scratch surfaces. Removes fingerprints, smears and soils. Oil-based. Helps restore shine. Virtually odorless.

58346461 76461 17 oz. 6/cs.

C. CREAM CLEANER & POLISH ZEP

Mildly abrasive cream cleaner will not scratch surfaces as it cleans. Use on all bathroom surfaces including chrome, fiberglass, brass, stainless steel, copper, and aluminum. Polishes and deodorizes in one application.

75070004 R00201 1 qt. 12/cs.



D. STAINLESS STEEL CLEANER & POLISH ZEP

Water-based stainless steel aerosol polish. May be used on other hard surfaces. Leaves a water resistant shield that inhibits fingerprints. Lemon fragrance. Leaves surface dry. VOC compliant.

75070115 R07901 24 oz. 12/cs.

E. PRE-MOISTENED STAINLESS STEEL POLISHING TOWELS ZEP

Heavy-duty Hydroknit® towels for use on stainless steel, chrome, and aluminum surfaces. Removes grease, fingerprints, water stains while brightening surfaces.

75070138 R09301 72 ct. 6/cs.



OVEN & GRILL CLEANERS

F. PRIME SOURCE® SPARK OVEN & GRILL CLEANER PRIME SOURCE®

Economical to use. Removes tough grease, grime and carbonized soil from ovens and grills.

75004150 75004150 18 oz. 12/cs.

76000765 76000765 511 g 12/cs.

75004151 75004151 1 qt. 12/cs.

76008551 76008551 946 mL 12/cs.

75004152 75004152 1 gal. 4/cs.

76008514 76008514 3.78 L 4/cs.



G. PRIME SOURCE® ULTRA GRILL CLEANER PRIME SOURCE®

For hot or cold surfaces. Removes tough grease, grime, carbonized soil from ovens/grills.

75004154 75004154 1 gal. 4/cs.

H. HEAVY-DUTY OVEN & GRILL HARD SURFACE CLEANER CARROLL

Highly alkaline, biodegradable cleaner and carbon remover. Penetrates help eliminate or reduce scouring and scraping. Effective on steel, stainless steel and porcelain surfaces. No fragrance added. USDA A8.

30010528 40528 1 gal. 4/cs.



I. AJAX® OVEN & GRILL CLEANER COLGATE-PALMOLIVE

High foaming degreaser-cleaner penetrates and removes baked on foods, grease and carbon deposits. Removes soil and food deposits, which can hamper the food's flavor.

Cleans on hot or cold surfaces. Non-flammable. Phosphate-free.

11904926 04926 32 oz. 12/cs.



J. MR. MUSCLE® OVEN & GRILL CLEANER DIVERSEY

Works immediately on warm or cold ovens. Self-scouring action with unsurpassed clinging ability. Specially designed to clean institutional, industrial and commercial surfaces including: Stainless steel, porcelain enamel, iron, undecorated ceramic tile, concrete and glass. Works well on ovens, grills, broilers, ventilating hoods, splash panels, steam table-tops, pots, pans, fryers and griddles. Use also on oven doors, fronts, windows and racks. Aerosol contains no CFCs. Packaging labels are bilingual (English and French).

15200087 91206 19 oz. Aerosol 6/cs.

15200151 91208 32 oz., Trigger Sprayer 6/cs.



CHEMICALS

Oven & Grill/Fryer Cleaners/Hand Dishwash



A. EASY-OFF® FUME-FREE MAX™ NON-CAUSTIC OVEN CLEANER **RECKITT BENCKISER**
 Advanced cold-oven technology penetrates tough oven grease and effectively cleans with no harsh fumes and no lye. No harsh chemicals, no need for protective gloves. Pleasant, fresh lemon scent. Bi-lingual label.
 58340178 00178 16 oz. 12/cs.



B. PROFESSIONAL EASY-OFF® Fume-Free Max™ Non-Caustic Oven Cleaner **RECKITT BENCKISER**
 Advanced cold-oven technology penetrates tough oven grease and effectively cleans with no harsh fumes and no lye. No harsh chemicals, no need for protective gloves. Pleasant, fresh lemon scent. Bi-lingual label.
 58344017 74017 24 oz. 6/cs.
Oven & Grill Cleaner
 Advanced grease-cutting formula for burned-on grease and grime. Self-scouring action cleans a wide variety of surfaces, equipment and utensils. Can be used on warm and cold ovens.
 58340138 00148 16 oz. 12/cs.
 58340395 04250 24 oz. 6/cs.
 Advanced ready-to-use formula quickly removes caked-on grease. Non-flammable, ready-to-use, thick formula clings to vertical surfaces. Rapid penetration saves time and money by minimizing scouring and scrubbing. Works on hot grills up to 170°F, no need to shut down grill. No offensive odor.
 58340022 80689 64 oz. 6/cs.



C. FRYER BOIL OUT **CCP**
 Removes the carbon build-up in fry pots and is economical and Easy-to-use. Clean heating elements maintain constant temperature during frying which results in quality foods and reduces fryer down time. Each container will provide approximately ten boil outs for a 50 lb. capacity fryer.
 27600769 FB08 8 lb., Standard 2/cs.



D. MR. MUSCLE® FRYER BOIL-OUT **DIVERSEY**
 Frequent cleaning with Mr. Muscle® Fryer Boil-Out enhances the characteristics of equipment and improves the quality of fried food. A clean fryer operates more efficiently and lasts longer. Carbonized grease that has accumulated on the interior surface of the fryer imparts a rancid flavor to deep-fried foods. This problem is eliminated with routine use of Mr. Muscle®, as shortening stays fresher and works longer in equipment that is cleaned on a regular basis. Portion control pouch helps simplify product handling, eliminates waste and control cost. Low-foaming formula degreases and cleans foodservice fryers, while preventing boil over. Heat and chemical action combine to penetrate, emulsify and clean away built-up grease. Eliminate the need for neutralizing. Non-corrosive. Contains no phosphates. NSF A8 Registered.
 15200086 91209 2 oz. 36/cs.



E. EMERALD ISLE FOAMING MANUAL DISH DETERGENT **PRIME SOURCE®**
 Lotionized dish washing liquid cleans even the greasiest dishes and glassware. Dries without spotting.
 75004582 75004582 1 gal. 4/cs.
 75004583 75004583 5 gal. 1/ea.
F. PINK DISH SOAP FOAMING MANUAL DISH DETERGENT **PRIME SOURCE®**
 Cleans even the greasiest dishes and glassware. Lotionized, exceptional mildness to hands. Dries without spotting.
 75004188 75004188 1 gal. 4/cs.
 75004195 75004195 1 gal., Kosher 4/cs.
 75004189 75004189 5 gal. 1/ea.

FRYER CLEANERS

HAND DISHWASH - LIQUID

Hand Dishwash



A. PREMIUM PLUS ULTRA BLUE DISH DETERGENT CONCENTRATE PRIME SOURCE®

Superior concentrate detergent has long-lasting action for use on the greasiest of soils. Enriched formula is easy on the hands for extended use.

75004584	75004584	1 gal.	4/cs.
75004585	75004585	5 gal.	1/ea.



B. PRIME SOURCE® EXCEL DISHWASH DETERGENT PRIME SOURCE®

High-sudsing action. Deep cleans even the greasiest dishes, pots and pans.

75004157	75004157	1 gal.	4/cs.
----------	----------	--------	-------

C. PRIME SOURCE® EXCEL EMERALD DISHWASH DETERGENT PRIME SOURCE®

High-sudsing action. Deep cleans even the greasiest dishes, pots and pans.

75004190	75004190	1 gal.	4/cs.
----------	----------	--------	-------



D. PRIME SOURCE® EMERALD ISLE DISH DETERGENT PRIME SOURCE®

Lotionized dish, pot and pan detergent. Neutral PH, rinses freely, highly concentrated.

75004192	75004192	1 gal.	4/cs.
----------	----------	--------	-------

E. PRIME SOURCE® FOAMY POT & PAN PINK LOTION DETERGENT PRIME SOURCE®

Gentle on hands. Can be used in a wide variety of applications.

75004186	75004186	1 gal.	4/cs.
----------	----------	--------	-------



F. PRIME SOURCE® LEMON DISH MANUAL DISHWASH DETERGENT PRIME SOURCE®

A low cost hand dishwash detergent designed to rinse freely without spots or streaks.

Performs in hard water and is gentle to skin. A.P.E. free. Lemon fragrance.

76008510	76008510	3.78 L	4/cs.
----------	----------	--------	-------

G. GREEN WORKS® POT & PAN DISHWASH CLOROX

Extraordinary cleaning power without harsh chemical residue left on your dishes. Made with natural ingredients like essential oils and coconut-based cleaners. Tough stains like greasy baked-on food easily rinse away, leaving nothing but a natural, streak-free shine. 99% all-natural ingredients. Easy on hands. Not tested on animals. Environmentally conscious.

38380381	30381	38 oz.	8/cs.
38380388	30388	1 gal.	4/cs.



H. S.O.S.® POT & PAN DETERGENT CLOROX

Cuts through grease fast. Long-lasting suds means fewer washwater changes. Versatile enough to clean walls and kitchen equipment. Economical, dilutes to pennies per sinkful.

Saves time and labor because it rinses quickly and easily. Emulsifies tough grease and lifts it to prevent repositing. No residue.

38380080	00001	1 gal.	4/cs.
----------	-------	--------	-------



I. AJAX® DISHWASHING LIQUID COLGATE-PALMOLIVE

Dishwashing Liquid

A powerful dish cleaner that is gentle on hands. Free-rinsing, it is ideal for hand washing dishes, glasses, and greasy pots and pans.

11904922	04922	1 gal.	4/cs.
----------	-------	--------	-------

Pink Rose Lotion Dish Detergent

For hand dish washing. Effective against grease. Pleasant rose fragrance.

11904616	14616	1 gal.	4/cs.
----------	-------	--------	-------

J. OCTAGON CRYSTAL WHITE® DISHWASHING LIQUID COLGATE-PALMOLIVE

Maximum economy for all manual systems. Maximum cost control where soil conditions are light to moderate.

11900037	14350	1 gal.	4/cs.
----------	-------	--------	-------

Hand Dishwash



CHEMICALS



A. PALMOLIVE® COLGATE-PALMOLIVE

Antibacterial Dishwashing Liquid

One product does the work of two: a powerful, grease-cutting manual dishwashing liquid and an antibacterial liquid hand soap. Grease-cutting formula provides outstanding cleaning. Gentle pH formula is soft on hands. Proven antibacterial protection for the hands when used as hand soap. Ultra concentrated.

11904789	04789	29 oz.	12/cs.
11904930	04930	1 gal.	4/cs.

Dishwashing Liquid

Cuts through stubborn grease. Rich, thick formula removes dried-on, cooked-on food. pH balanced. Long-lasting performance makes it an economical choice.

11900047	20181	850 mL	12/cs.
----------	-------	--------	--------

Original Dishwashing Liquid

Cuts through stubborn grease. Rich, thick formula removes dried-on, cooked-on food. pH balanced. Long-lasting performance makes it an economical choice. DfE approved formula. Ready-to-use.

11901640	04910	1 gal., Green	4/cs.
11901660	04911	5 gal., Green	1/ea.

Plus Dishwashing Liquid

Cuts through stubborn grease. Rich, thick formula removes dried-on, cooked-on food. pH balanced. Long-lasting performance makes it an economical choice. DfE approved formula. Ready-to-use.

11901702	01410	3 ³ / ₄ oz., Green	72/cs.
----------	-------	--	--------



B. ULTRA PALMOLIVE® COLGATE-PALMOLIVE

Antibacterial Dishwashing Liquid/Hand Soap

Provides all the benefits of a dishwashing detergent and an antibacterial hand soap. When used to clean dishes, long-lasting suds have the power to clean even the greasiest pots and pans while still being soft on hands. Proven antibacterial protection when used as a hand soap. Kosher approved. Ultra concentrated.

11904791	47914	13 oz.	20/cs.
11900032	47928	25 oz.	12/cs.

Dishwashing Liquid

Cuts through stubborn grease. Rich, thick formula removes dried-on, cooked-on food. pH balanced. Concentrated for long-lasting performance.

11906225	46225	25 oz., Fresh Green Apple	12/cs.
----------	-------	---------------------------	--------

Dishwashing Liquid For Pots & Pans

Highly concentrated formula tackles the toughest foodservice dishwashing tasks. Ideal for use as a presoak. Great as a general all-purpose cleaner, its grease-cutting ability makes it perfect for cleaning tables, countertops, windows, mirrors and more. Ocean Breeze scent. DfE approved formula.

11900056	40043	1 gal.	4/cs.
----------	-------	--------	-------

Original Dishwashing Liquid

Cuts through stubborn grease. Rich, thick formula removes dried-on, cooked-on food. pH balanced. Long-lasting performance makes it an economical choice.

11906115	46114	13 oz., Green	20/cs.
11901029	46128	25 oz., Green	12/cs.
11907430	47430	64 oz.	6/cs.



C. SUNLIGHT® POT & PAN DISHWASH LIQUID DIVERSEY

For institutional use. Ideal for the greasiest dishes, glassware, cutlery or pots and pans. pH balanced for mildness. Super concentrated, high active, high sudsing pot and pan formula.

15200155	2979486	3 oz.	90/cs.
15200117	2979460	5 gal.	1/ea.



D. DAWN® MANUAL POT & PAN DETERGENT PROCTER & GAMBLE

Cuts the tough grease others leave behind. High surfactant formula seeks out greasy soil, cuts through it, surrounds the removed soil and lifts it out of your way. Optimal blend of five different surfactants provides the power to cut and emulsify grease.

16905113	45113	38 oz., Lemon	8/cs.
16905112	45112	38 oz., Original	8/cs.
16902619	02619	1 gal., Lemon	3/cs.
16902613	02613	1 gal., Original	3/cs.
16908077	08077	5 gal., Lemon	1/ea.
16900134	02611	5 gal., Original	1/ea.

Hand Dishwash/Bar Glass Sanitizers



A. IVORY® LIQUID DISH DETERGENT PROCTER & GAMBLE

For hand washing of dishes, pots and pans. Cleans a wide variety of soils and is mild on employee hands.

16900620 00620 12.6 oz. 25/cs.



B. JOY® DISHWASHING LIQUID PROCTER & GAMBLE

Powerful surfactants to clean a wide variety of soils. Designed to be mild. High surfactant level to give a rich layer of suds and high suds mileage. Forms surfactant micelles that stay suspended in wash water to provide micro-reservoirs of reserve cleaning power.

Concentrated; use 1 to 3 fl. oz. per 10 gal. sink. Lemon scent.

16905114 45114 38 oz. 8/cs.
16900131 02302 1 gal. 3/cs.
16908163 08163 5 gal. 1/ea.



C. PROFESSIONAL EASY-OFF® DISH DETERGENT RECKITT BENCKISER

Heavy-duty formula developed for manual washing of dishes, pots, pans and utensils. Long-lasting suds are tough on greasy soils but leave no soapy film or residue. Soaks stubborn soil-free without hard scrubbing. Concentrated formula is economical to use; makes up to 512 gallons.

58340003 74381 1 gal. 4/cs.



HAND DISHWASH - POWDER

D. PRIME SOURCE® PINK SUDS HAND WASHING & ALL PURPOSE DETERGENT PRIME SOURCE®

High-sudsing; reduces redeposition of soil. Fast-rinsing saves time and money. Results in surfaces drying spot and streak-free. Biodegradable, so it's environmentally safe.

75004180 75004180 50 lb. 1/ea.
75004179 75004179 100 lb. 1/ea.

E. AJAX® ARCTIC® SYNTAX™ DISHWASHING BEADS COLGATE-PALMOLIVE

High-sudsing pink powder for hand cleaning dishes, pots, pans. Fast-dissolving, grease-cutting formula is free-rinsing and gentle on hands. Contains corrosion and tarnish inhibitors. Tableware is left clean and streak-free.

11901620 04368 25 lb. 1/ea.

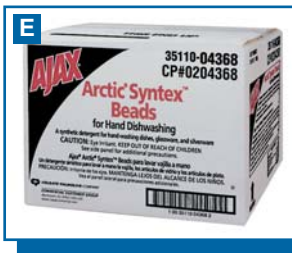

F. CREAM SUDS® POT & PAN PRESOAK & DETERGENT PROCTER & GAMBLE

Designed for soaking tough, baked-on foods from pots and pans. Effective on greasy soils. Can be used on wide variety of washable surfaces, such as floors, walls, stainless and countertops.

16908736 08736 25 lb., Phosphate 1/ea.
16908605 02120 25 lb., w/o Phosphate 1/ea.
16902101 02101 50 lb., Phosphate 1/ea.



BAR GLASS SANITIZERS

G. BEER CLEAN® DIVERSEY

Last Rinse Sanitizer

Powdered compound contains trichloromelamine (TCM) for effective sanitization of bar glassware. Laboratory tested—kills E.coli and Staph. Delivers 100 ppm available chlorine. Accepted by breweries throughout North America.

15200095 90223 1/4 oz. Packets 100/cs.
15200093 90203 25 oz. 2/cs.

Low Suds Glass Cleaner - Electric Brush

For sparkling clean glassware and better tasting beer. Powdered compound cleans in hot-cold, hard or soft water. Concentrated formula for quick cleaning. Odorless detergent system provides excellent rinsing results. Minimal sudsing. Two formulas: Regular for manual brush cleaning and Low Suds for use with electric brushes.

15200096 90224 1/2 oz. Packets 100/cs.
15207650 90241 4 lb. 2/cs.



CHEMICALS

Bar Glass Sanitizers/Machine Dishwash

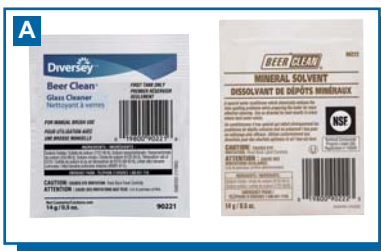

A. BEER CLEAN® (CONT.) DIVERSEY

Glass Cleaners - Manual Brush

For sparkling clean glassware and better tasting beer. Powdered compound cleans in hot-cold, hard or soft water. Concentrated formula for quick cleaning. Odorless detergent system provides excellent rinsing results. Minimal sudsing. Two formulas: Regular for manual brush cleaning and Low Suds for use with electric brushes

15200094	90221	1/2 oz. Packets	100/cs.
15200092	90201	4 lb.	2/cs.

Mineral Solvent

Serves as a "booster" in the water softening process—especially important in adjusting local water conditions. Ties up hard water minerals to obtain maximum cleaning results. Single use packet for better dilution control. NSF G6 Registered for steam table treatment.

15207630	90222	1/2 oz.	100/cs.
----------	-------	---------	---------

MACHINE DISHWASH - LIQUID

B. PALMOLIVE® ECO+ LIQUID GEL AUTOMATIC DISHWASHING DETERGENT COLGATE-PALMOLIVE

Automatic dishwasher detergent leaves your dishes sparkling clean. Dissolves quickly without caking. Eliminates spots and film often caused by powders.

11900007	42706	75 oz., Lemon	6/cs.
----------	-------	---------------	-------

MACHINE DISHWASH - POWDER

C. PRIME SOURCE® FEATHER BEADS HIGH SUDSING DISHWASHING DETERGENT PRIME SOURCE®

Economical and can be used in hot or cold, soft or hard water. Fast-rinsing; saves time and money. Biodegradable, so it's environmentally safe.

75004184	75004184	25 lb.	1/ea.
----------	----------	--------	-------

D. PRIME SOURCE® SUPER CHLOR MACHINE DISH DETERGENT PRIME SOURCE®

Non-foaming, fast rinsing detergent. For use in automated dishwashers. Cuts through grease and fats. Removes dried-on foods and films.

75004183	75004183	25 lb.	1/ea.
----------	----------	--------	-------

E. SUNLIGHT® MACHINE DISHWASHING DETERGENT DIVERSEY

High alkaline, chlorinated machine dishwashing formula with built in sheeting action.

15200121	2979558	1 1/2 oz.	100/cs.
----------	---------	-----------	---------

F. CASCADE® DISHWASHER DETERGENT PROCTER & GAMBLE

Specially formulated for under counter automatic dishwashing. Sheeting action for virtually spotless dishes.

16900933	00801	20 oz.	24/cs.
16900092	34034	45 oz., Powder Fresh	12/cs.
16909921	39921	85 oz.	6/cs.

G. ELECTRASOL® RECKITT BENCKISER

Automatic Dishwash Detergent

Professional formula for pot and pan dishwashing. Deep cleaning power gently removes tough food stains, leaving dishes with a sparkly shine.

58348234	78234	75 oz., Lemon Scent	6/cs.
----------	-------	---------------------	-------

Powerball Automatic Dishwash Detergent 3-In-1 Tabs

3-in-1 Tabs with Jet Dry Powerball provides convenient pre-measured detergent without the mess of a liquid. Tabs contain special cleaning agents that remove the toughest food stains. Gently scrubs dishes while providing encapsulated Jet Dry water-soluble rinse agents that eliminate water spots.

58340919	77050	20 Tabs, Fresh	160/cs.
----------	-------	----------------	---------



Sanitizing Solutions/Laundry Detergent



SANITIZING SOLUTIONS

A. PREMIUM PLUS ULTRA NO RINSE SANITIZERS PRIME SOURCE®

No need to rinse. Perfect for third-sink operations. For use on food processing equipment and food contact surfaces.

75004586	75004586	1 gal.	4/cs.
75004587	75004587	5 gal.	1/ea.



B. PRIME SOURCE® SANI RINSE DISINFECTANT SANITIZERS PRIME SOURCE®

Does not require potable water rinse for glassware and cooking utensils. EPA Registered; use dilution 1:512. *Check with us regarding availability/product registration status in your state.

75004020	75004020	1 gal.	4/cs.
75004021	75004021	5 gal.	1/ea.



C. AJAX EXPERT® LIQUID SANITIZER COLGATE-PALMOLIVE

Use in third sink for sanitizing warewashing items or in spray bottle for counters, tabletops and in-place equipment. No chlorine odor formula is effective in hard water up to 500 ppm. 1/4 oz. per gal. dilution; 1 gal. of concentrate makes 512 gal. of ready-to-use sanitizer solution. Multi-quat formula with FD&C red color. Deodorizes and leaves no residual odors. EPA Registration No. 6836-70-4582.

11904963	04963	1 gal.	4/cs.
----------	-------	--------	-------



D. AJAX® SANITIZER CLEANER POWDER COLGATE-PALMOLIVE

Super concentrated 1/4 ounces per 2 1/2 gallons of water. 8 lb. container makes 1,280 gallons of sanitizer solution. For third sink, clean in place, soft serve and presoak applications.

Contains cleaning agents to remove milkstone from equipment surfaces. Contains chlorine as the active ingredient and is non-clumping. EPA Registration No. 10634-19-4582.

11904967	04967	8 lb.	1/ea.
----------	-------	-------	-------

E. JOHNSON® LIQUID BLOCK WHITENER DIVERSEY

Non-corrosive thick liquid formula provides lightning quick cleaning and whitening of cutting boards. RTU container.

15204404	4404	1 gal.	4/cs.
----------	------	--------	-------

F. CLEAN QUICK® PROCTER & GAMBLE

Chlorine Sanitizer

Chlorine, non-rinse sanitizer. For third-sink sanitizing of dishes, glassware, silverware, and cooking utensils or sanitizing hard (non-porous) surfaces, such as food processing equipment or utensils. 100 ppm chlorine when mixed at 1 oz of sanitizer per 10 gallons of water. Contains 25% sodium dichloro-s-triazinetrione dihydrate.

16908524	02584	1 oz., Single Use Packets	100/cs.
----------	-------	---------------------------	---------

Liquid Quaternary Sanitizer

Quaternary, non-rinse sanitizer, sanitizes without leaving chlorine bleach odors. For third-sink sanitizing of dishes, glasses, silverware, and cooking utensils. Also use to sanitize hard (non-porous) surfaces, such as chopping blocks and countertops. Light pink color confirms product presence in third sink. 200 ppm active quaternary when diluted at 1 fl. oz. of sanitizer to 5 1/2 gallons of water.

16907535	07535	1 gal., w/Test Strips	3/cs.
----------	-------	-----------------------	-------



G. DIP-IT® COFFEEMAKER CLEANER RECKITT BENCKISER

Liquid cleaner dissolves and removes build-up of lime, calcium and other water deposits.

58346320	36320	7 oz.	8/cs.
----------	-------	-------	-------



H. ALL® LIQUID LAUNDRY DETERGENT DIVERSEY

All® uses Stainlifters™ to safely lift dirt and stains.

15200111	2979208	1 gal.	4/cs.
----------	---------	--------	-------



LAUNDRY DETERGENT - LIQUID



Laundry Detergent

CHEMICALS



A. WISK® LIQUID LAUNDRY DETERGENT DIVERSEY

Concentrated liquid attacks everything from protein stains to oily dirt. Use as a powerful stain pre-treatment or all purpose cleaner/degreaser. Provides optimum results on all fabrics in all wash conditions.

15200180	2979945	2 oz., Coin Vend Pack	100/cs.
15200130	2979890	1 gal., Heavy-Duty	4/cs.

B. TIDE® PROCTER & GAMBLE

2X Liquid Laundry Detergent

2X concentrated to give you twice the stain-fighting power in every drop. You get the same number of loads in a smaller, more convenient bottle. Plus the new formula removes stains better than before. One small cap gets your clothes beyond clean, it gets them ultra clean. Dye and perfume-free. For sensitive skin.

16903878	13878	50 oz.	6/cs.
----------	-------	--------	-------

Ultra 2X Liquid Laundry Detergent

2X concentrated to give you twice the stain-fighting power in every drop. You get the same number of loads in a smaller, more convenient bottle. Plus the new formula removes stains better than before. One small cap gets your clothes beyond clean, it gets them ultra clean. Dye and perfume-free. For sensitive skin.

16908886	08886	100 oz., 64 Load	4/cs.
----------	-------	------------------	-------

LAUNDRY DETERGENT - POWDER

C. PRIME SOURCE® CARALO LAUNDRY DETERGENT PRIME SOURCE®

Controlled suds laundry detergent. Contains brightening and whitening agents. For automatic and non-automatic machines.

75004171	75004171	50 lb.	1/ea.
----------	----------	--------	-------

D. PRIME SOURCE® LOW SUDS II LAUNDRY DETERGENT PRIME SOURCE®

Penetrate soils for effective cleaning. Safe to use; formulated to clean, preserves fabric life. Economical; cleans thoroughly and rinses quickly, meaning no need for extra rinses. Biodegradable, so it's environmentally safe.

75004172	75004172	50 lb.	1/ea.
----------	----------	--------	-------

E. ALTA LAUNDRY DETERGENT CARROLL

Economical, non-phosphoric, controlled suds, free flowing detergent. Contains brightening and whitening agents for automatic washing machines. All temperature, all machine types; water soluble detergent. Lemon fragrance.

30011110	91110	50 lb.	1/ea.
----------	-------	--------	-------

F. ULTRA PUREX® DRY LAUNDRY DETERGENT DIAL

Whitens and brightens clothes. Helps prevent dinginess. Enhanced blend of surfactants and builders performs well in all temperatures and leaves clothes with a fresh, clean scent. Color Shield® protects colors from fading. Biodegradable. Phosphate-free.

12801837	01837	80 Use, 107 oz. Box	3/cs.
----------	-------	---------------------	-------

G. ALL® DIVERSEY

Concentrated Powder Laundry Detergent

For large laundry loads. Quality performance, yet low cost per use. High efficiency formula is suitable for use in front load and top load machines. Effective in all water temperatures.

15200112	2979216	50 lb., Concentrated	1/ea.
----------	---------	----------------------	-------

Multi-Purpose Detergent

Lifts out tough dirt and oily stains. Low sudsing. Performs at all temperatures. HE formula suitable for use in both front load and top load machines. Can also be used on floors, concrete pads and other surfaces. Contains no phosphorus.

15200113	2979232	17 lb., Flip Top Pail	1/ea.
----------	---------	-----------------------	-------

Ultra Powder Laundry Detergent

Formulated with Stainlifters™ to lift out tough dirt and oily stains. Excellent in all water temperatures. Designed for the vending opportunities in laundromats and guest amenities.

15200115	2979267	(100) 2 oz., Coin Vend Pack	100/cs.
15200176	2979304	150 Use	1/ea.

Laundry Detergent/Bleach



A. SURF ULTRA® POWDER LAUNDRY DETERGENT DIVERSEY

Unique, heavy-duty detergent attacks stubborn dirt and controls odors. "Active Oxygen" formula lifts dirt and stains, and works in all temperatures.

15200158 2979814 2 oz., Coin Vend Pack 100/cs.



B. TIDE® PROCTER & GAMBLE

Dry Laundry Detergent

Tide® dry laundry detergent with hydrogen peroxide. High-powered, grease-cutting formula effective on tough, greasy food stains.

16902280 42280 263 oz. 2/cs.

Laundry Detergent w/Wearcare

Powder laundry detergent. Helps cotton threads stay strong. Helps cotton colors not fade. Cotton clothes virtually don't age. Non-phosphate. Safe for septic tanks.

16900804 30804 33 oz. 15/cs.

w/Bleach Powder Laundry Detergent

Contains an active bleaching system. Removes many tough stains and whitens whites. Helps keep colors bright. No phosphate. Harmless to septic tanks. Kills 99.9% bacteria (effective against Staphylococcus aureus and Klebsiella pneumoniae; use as directed).

16900095 40026 8 oz. 14/cs.

16902370 32370 26 oz. 15/cs.

16902282 42282 214 oz. 2/cs.



C. ULTRA CHEER® 2 POWDERED LAUNDRY DETERGENT PROCTER & GAMBLE

Provides both outstanding cleaning power and color protection with new Triple Color Guard®. First product that is not a cotton-containing garment ever to bear the cotton incorporated seal for fabric and color care. Formulated with Carezyme, a proprietary technology which provides superior color protection and reduces the buildup of fuzz on cotton fabrics which can make clothes look dull and worn. 120 uses.

16906448 38448 263 oz. 2/cs.

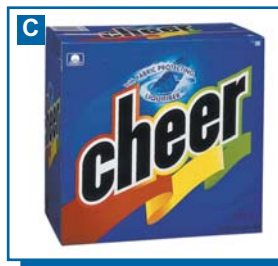

BLEACH

D. CLOROX® BLEACH PEN CLOROX

Unique dual-tip pen delivers Clorox® gel formula bleach only where it is needed. Use on most white fabrics just where bleach is needed. Use on grout or caulking. Use on areas around sinks and tubs. Use for detailed bleach cleaning.

38384690 04690 2 oz. 12/cs.



E. ULTRA CLOROX® CLOROX

2 Color Safe Bleach

This familiar dry product gives you the flexibility to pre-soak your stains. Original clean laundry scent.

38383116 03116 30.3 oz. 6/cs.

Liquid Bleach

Ideal for disinfecting and deodorizing bathtubs, showers, sinks, dishcloths and sponges.

38382450 02450 24 oz., Regular Scent 12/cs.

38382510 02510 60 oz., Regular Scent 8/cs.

38382467 02467 96 oz., Rain Clean Scent 6/cs.

38382440 02452 96 oz., Regular Scent 6/cs.

Liquid Germicidal Bleach

Concentrated formula is super-filtered to remove impurities that can break down ordinary bleach. Sanitizes and disinfects hard surfaces. Will not leave a residual odor. Effective against the HIV-1 (AIDS) virus, TB and Hepatitis-A. Complies with OSHA's Blood Borne Pathogens Standard. Meets FDA guidelines for sanitizing food contact surfaces. USDA Classification C1. EPA registered.

38382491 02490 96 oz. 6/cs.

38382489 02489 182 oz. 3/cs.



F. DRY CHLORINE BLEACH DIVERSEY

Removes stains and brightens whites. Designed for the vending opportunities in laundromats and guest amenities.

15200123 2979646 2 oz., Coin Vend Pack 100/cs.



Stain Removers/Fabric Softeners

STAIN REMOVERS



A. SHOUT® DIVERSEY

Triple-Action Laundry Stain Remover

Combines the cleaning power of lemon with other powerful stain fighters to quickly penetrate, break-up and eliminate the toughest, greasiest stains. Effective on motor oil, grass, blood and other protein-based stains. Safe for all colorfast washables.

15200137 CB022514 20 oz., Trigger Sprayer 12/cs.

Wipes

Pre-moistened towelette instantly reduces stains. Cuts grape juice, coffee, blood and baby formula. Pre-treat stains on clothing— even during wear. Safe on colorfast washable and dry-cleanable fabrics. Individually wrapped towelettes. Convenient and portable.

15200171 94354 1 ct., 4⁷/₁₀" x 5⁹/₁₀" 80/cs.

15200104 CB022460 12 ct., 4⁷/₁₀" x 5⁹/₁₀" 12/cs.



B. TIDE® TO GO STAIN REMOVER PEN PROCTER & GAMBLE

Eliminates most stains on clothing. Convenient to use. For immediate stain removal and pre-treat applications.

16900458 84950458 10 mL 6/cs.

C. SPRAY 'N WASH® RECKITT BENCKISER

Specially formulated with powerful stain fighting ingredients to eliminate the toughest stains. Safe for all colorfast washables. Works in all temperatures.

58340230 00230 22 oz., Trigger Sprayer 12/cs.

FABRIC SOFTENERS



D. SNUGGLE® DIVERSEY

Concentrated Liquid Fabric Softener

Concentrated, professional formula liquid fabric softener for the wash cycle gives clothes a special freshness while reducing static cling. Cuddle-up fresh scent.

15200134 2979953 2 gal., w/Pump 2/cs.

Fabric Softener Sheets

Convenient dryer sheets reduce static cling and leave clothes soft and fresh. Cuddle-up fresh scent. Designed for the vending opportunities in laundromats and guest amenities.

15200132 2979929 2 Sheets, Coin Vend Pack 100/cs.

Liquid Fabric Softener

Liquid fabric softener for the wash cycle gives clothes a special freshness while reducing static cling. Cuddle-up fresh scent. Designed for the vending opportunities in laundromats and guest amenities.

15200136 2979996 1½ oz. 100/cs.

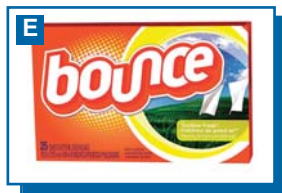

E. BOUNCE® DRYER SHEETS PROCTER & GAMBLE

Helps reduce static cling on garments as they come out of the dryer and as they are worn. Time released freshness. Softness you can feel. Outdoor fresh scent.

16907267 10038 25 ct. 375/cs.

16907270 37270 160 ct. 160/cs.



F. DOWNY® FABRIC SOFTENERS PROCTER & GAMBLE

Liquid fabric softener. April Fresh scent. Rinse-added fabric softener for fluffy softness. Helps reduce static cling.

16900706 00706 10 oz. 12/cs.

16905762 35762 51 oz. 8/cs.

16906447 06447 64 oz. 8/cs.

Aerosol Disinfectants



AEROSOL DISINFECTANTS

A. PRIME SOURCE® HOSPICIDE DISINFECTANT SPRAYS PRIME SOURCE®

Hospital grade disinfectant. Kills HIV-1 and Herpes. Can be used as a deodorant air freshener. EPA registered. *Check with us regarding availability/product registration status in your state.

75004033	75004033	15 oz.	12/cs.
76000764	76000764	440 g	12/cs.



B. PRIME SOURCE® SCRUBBLES FOAMING DISINFECTANT CLEANER PRIME SOURCE®

Quaternary foaming cleaner and deodorant. Use on all restroom fixtures as well as vinyl and leather. Effective on mold and mildew. EPA registered. *Check with us regarding availability/product registration status in your state.

75004034	75004034	18 oz.	12/cs.
-----------------	----------	--------	--------



C. CLOROX® DISINFECTING SPRAY CLOROX

Sanitizes, disinfects and deodorizes in a wide variety of areas. Excellent for use in nursing homes, hospitals, daycare centers, school and hotels. Effective disinfectant against E. coli, TB, HIV-1 and Hepatitis-A. Complies with OSHA guidelines for blood-borne pathogens.

38388504	38504	19 oz.	12/cs.
-----------------	-------	--------	--------



D. END BAC® II DISINFECTANT SPRAY DIVERSEY

Quaternary and ethyl alcohol formula eliminates odors caused by bacteria. Kills staph, strep, athlete's foot fungus and many other surface germs. Germicidal, Virucidal, Antibacterial and Tuberculocidal. Prevents mold and mildew growth on hard surfaces. EPA registered.

15204832	4832	15 oz.	12/cs.
-----------------	------	--------	--------



E. LYSOL® RECKITT BENCKISER

Brand I.C.™ Foaming Disinfectant Cleaner

Ready-to-use quaternary formula cleans, disinfects and deodorizes. Contains no harsh acids, abrasives or bleach. Meets AOAC efficacy standards for hospital aerosol disinfectants. NSF Category Code C2, Reg. No. 123640.

58345524	95524	24 oz.	12/cs.
-----------------	-------	--------	--------

Brand II I.C.™ Disinfectant Spray

Kills 99.9% of germs on hard, non-porous surfaces in 30 seconds. This product is effective against the H1N1 strain of Influenza A and the Influenza A virus. Tuberculocidal, virucidal, fungicidal and bactericidal. Meets AOAC Germicidal Spray Product Test standards for hospital aerosol disinfectants. Control Flo™ valve produces a wetter spray, enhancing surface coverage. NSF Category Code C1, Reg. No. 083684.

58345029	95029	19 oz.	12/cs.
-----------------	-------	--------	--------

Brand III Disinfectant Spray To Go

Perfect travel size, take it wherever you go. Kills 99.9% of germs in 30 seconds. Eliminates odors.

58349132	79132	1 oz., Crisp Linen	12/cs.
-----------------	-------	--------------------	--------



F. PROFESSIONAL AMPHYL® III DISINFECTANT DEODORANT SPRAY RECKITT BENCKISER

Kills 99.9% of germs. Effective against the H1N1 strain of Influenza A and the Influenza A virus. Effective disinfectant that kills odor-causing bacteria at their source. Tuberculocidal, virucidal, fungicidal and bactericidal. Effective against MRSA, Norovirus, Rhinovirus, HIV-1 (AIDS Virus), Poliovirus Type 1 and Hepatitis A.

58348300	08300	13 oz.	12/cs.
-----------------	-------	--------	--------



Aerosol & Liquid Disinfectants



CHEMICALS

A. PROFESSIONAL LYSOL® RECKITT BENCKISER

Brand III Disinfectant Sprays

Kills 99.9% of germs on hard, non-porous surfaces within 30 seconds. Formula is tuberculocidal, virucidal, fungicidal and bactericidal. Effective against HIV-1 (AIDS virus), Poliovirus Type 1 and Hepatitis A. Prevents odors and growth of damaging mold and mildew. Meets AOAC germicidal spray product test standards for hospital aerosol disinfectants.

Meets the requirements for the OSHA Bloodborne Pathogens Standard for Decontamination. EPA Registration No: 777-72-675.

58344185	74185	6 oz., Crisp Linen	12/cs.
58344186	74186	12 oz., Crisp Linen	12/cs.
58342845	02845	12 oz., Spring Waterfall	12/cs.
58344276	74276	19 oz., Country	12/cs.
58344828	74828	19 oz., Crisp Linen	12/cs.
58344675	04675	19 oz., Fresh	12/cs.
58344650	04650	19 oz., Original	12/cs.
58346075	76075	19 oz., Spring Waterfall	12/cs.

Disinfectant Foam Cleaner

Kills Staph, Salmonella, Pseudomonas, HIV-1 (AIDS virus) and other harmful germs on hard, non-porous surfaces (hospital disinfection). Rich foam clings to vertical surfaces. Unique aerosol valve allows spraying from any position, even upside down. Cleans, shines, disinfects and deodorizes. Contains grease cutting agents. Prevents growth of damaging mold and mildew. NSF Category Code C2, Reg. No. 123478.

58345080	02775	24 oz.	12/cs.
----------	-------	--------	--------

B. QUAT DISINFECTANT & DEODORIZER ZEP

Aerosol quat disinfectant deodorizer and cleaner. Powerful clinging foam is ideal for all hard surfaces such as bathroom fixtures, floors and tables. Pleasant fresh fragrance.

75070035	R02501	20 oz.	12/cs.
----------	--------	--------	--------

LIQUID DISINFECTANTS

C. MINT KLEANSE DISINFECTANT CLEANERS PRIME SOURCE®

Deodorizing disinfectant cleaner with a fresh mint fragrance. Dilutes at 5 oz. per gallon for cleaning and disinfection. EPA registered.

75004026	75004026	1 gal.	4/cs.
75004027	75004027	5 gal.	1/ea.
75004028	75004028	55 gal.	1/ea.

D. PRIME SOURCE® NU QUAT NEUTRAL HOSPITAL GRADE DISINFECTANTS PRIME SOURCE®

Exceptional cosmetic grade fragrance. Kills HIV-1 (AIDS virus), MRSA, VRSA and VRE. EPA registered. *Check with us regarding availability/product registration status in your state.

75004023	75004023	1 gal.	4/cs.
76008530	76008530	3.78 L, Lemon	4/cs.
76008527	76008527	3.78 L, Pine	4/cs.
76008528	76008528	18.9 L, Pine	1/ea.

E. BREEZE RTU DISINFECTANT CLEANER CARROLL

Non-acid quat formula, won't harm metal/restroom surfaces. Hospital grade foaming cleaner, HIV claim. One step clean and deodorize for bath and bowl. Citrus fragrance.

30010443	70223	1 qt.	12/cs.
----------	-------	-------	--------

F. CLEAR CLEANER/DISINFECTANTS CARROLL

Quat-based formula, hospital use plus HIV claim. Excellent neutral cleaner on washable hard surfaces. Won't dull detergent resistant floor finishes.

30010222	77628	1 gal., Lemon	4/cs.
30010209	75628	1 gal., Mint	4/cs.
30013628	73628	1 gal., Pine	4/cs.

G. OMNI-Q HOSPITAL GRADE DISINFECTANT CLEANER CARROLL

Quat-based formula, broad spectrum, hospital grade. Effective against Tuberculosis (TB), HIV, Parvo, and E. Coli. Non-acid bathroom cleaner; safe on most hard surfaces. Unique, fresh fragrance. USDA D-1.

30010199	73123	1 qt.	12/cs.
----------	-------	-------	--------

Liquid Disinfectants



A. PINE II® PINE ODOR DISINFECTANT CARROLL

Pine II® is a disinfectant that leaves the pleasant, but not overpowering, deodorizing fragrance of pine. Combines the known and proven disinfecting properties of a phenolic germicide and the deodorizing abilities of pine oil to provide the desired qualities for use in most restroom sanitation programs. EPA registered, USDA C-1.

30010225 79028 1 gal. 4/cs.



B. CLOROX CLEAN-UP® DISINFECTANT CLEANERS W/BLEACH CLOROX

Cleans, disinfects, and deodorizes hard, non-porous surfaces in hospital and industrial facilities.

38381266 35417 32 oz. 9/cs.

38381250 35420 1 gal. 4/cs.



C. PINE-SOL® DISINFECTANT/DEODORIZER CLOROX

Rapidly cuts dirt and grease on hard surfaces. No rinsing required. Deodorizes with a fresh Lemon scent. At full strength, an EPA Registered disinfectant for non-food contact surfaces. Biodegradable. Phosphate-free.

38380239 40239 60 oz., Lemon 6/cs.



D. AJAX EXPERT® DISINFECTANT CLEANER/SANITIZER COLGATE-PALMOLIVE

One step process to clean, disinfect and sanitize. Use as a fungicide, mildew stat, and virucide. Sanitizer inhibits the growth of mold and mildew and their odors. Effective against a broad spectrum of bacteria. One gallon of concentrate makes 64 gal. of ready-to-use solution. Does not contain phosphorous. EPA Registration No. 61178-1-4582.

11904117 04117 1 gal. 2/cs.

E. FORWARD™ DC GENERAL PURPOSE DISINFECTANT CLEANER DIVERSEY

The high powered quaternary disinfectant cleaner that removes the dirt, kills the germs, and leaves the shine. It's fast and powerful, cuts through and emulsifies tough soils. Gentle enough for all washable surfaces. Can be used as a hard surface sanitizer at 1:64, or as a general purpose deodorizing cleaner at 1:128. EPA registered.

15209702 4545 1 gal., 1:20-1:64 4/cs.



F. VIREX® TB GERMICIDAL CLEANER DEODORANT DIVERSEY

Ready-to-use formula provides excellent cleaning, disinfecting and deodorizing in one step. Patented quaternary formula kills TB and HIV-1 so it meets OSHA's Bloodborne Pathogen clean-up standard. Much less corrosive than phenolics or bleach. EPA registered.

15204743 4743 32 oz. 12/cs.



G. QUEST 256™ DISINFECTANT CLEANER DIVERSEY

Fragrance-free neutral disinfectant cleaner. Non-alkaline formula cannot dull floor finishes. Long dilution economy. Cleans away soils that many neutral disinfectants leave behind. Keeps mops looking cleaner, longer. EPA and DIN/PCP registered. Contains quaternary ammonium chlorides.

57081606 4298110 1 gal., 1:256 4/cs.



H. COMET® CRÈME DISINFECTANT CLEANSER PROCTER & GAMBLE

Bleaches tough stains. Disinfects as it cleans. Abrasive powder cleanser with chlorine bleach in a cream form for scouring tough stains on toilet bowls, wall tiles, tubs, sinks, chrome, stove tops and ranges, pots and pans. Clings to vertical surfaces. Aggressive abrasives are safe for most hard surfaces, but can scratch softer ones. Effective against staphylococcus, salmonella, and pseudomonas. EPA Registration No. 3573-46.

16900869 08069 32 oz. 9/cs.



I. LYSOL® Disinfectant Concentrate RECKITT BENCKISER

Powerful disinfectant that eliminates germs and odors throughout the home.

58342291 02201 12 oz., Original 12/cs.

I.C.™ Quaternary Disinfectant Cleaner

Hospital disinfectant cleans and disinfects hard, non-porous surfaces. Economical, concentrated formula makes up to 256 gallons. Virucidal, fungicidal and bactericidal. Multi-purpose, neutral pH, germicidal detergent and deodorant. EPA Registration No: 47371-129-675.

58344983 74983 1 gal. 4/cs.



CHEMICALS

Liquid Disinfectants/Restroom Cleaners



CHEMICALS



A. PROFESSIONAL AMPHYL® HOSPITAL BULK DISINFECTANT CLEANER RECKITT BENCKISER

Economical, concentrated phenolic-based disinfectant that dilutes 1:100 for broad-spectrum use and 1:50 for hospital disinfection. Virucidal, fungicidal, germicidal and tuberculocidal. Sanitizes laundry, linens, blankets and cloth diapers. Prevents odors and growth of mold and mildew. NSF Category Code C2, Reg. No. 123485.

58340014 02500 1 gal. 4/cs.

B. PROFESSIONAL LYSOL® RECKITT BENCKISER

Disinfectant Deodorizing Cleaners

Kills Staph, Strep and HIV-1 (AIDS virus). Prevents odors and growth of damaging mold and mildew. Cleans, disinfects and deodorizes. Economical, concentrated formula makes up to 64 gallons (1:64).

58346185 76185 1 gal., Fresh 4/cs.

58346334 76334 1 gal., Lemon 4/cs.

Disinfectant Pine Action® Cleaner

Kills Staph, Strep, Salmonella and other harmful germs on hard, non-porous surfaces. Prevents odors and growth of damaging mold and mildew. Economical, concentrated formula makes up to 64 gallons. Fresh pine scent. EPA Registration No: 777-82-675.

58342814 02814 1 gal. 4/cs.

C. SIMPLE GREEN® SIMPLE GREEN

D Pro 3 One-Step Germicidal Cleaners & Deodorants

High concentrate that must be diluted prior to use. Fresh herbal pine scented hospital-grade germicidal cleaner. Effective against gram+ and gram- bacteria, HIV-1, Influenza A and more. Used for cleaning, disinfecting and deodorizing hard, non-porous surfaces.

73430301 30301 1 gal. 6/cs.

73430305 30305 5 gal. 1/ea.

D Pro 5 One-Step Disinfectants

One-step disinfectant. Also works as a cleaner, sanitizer, fungicide, mildewstat, virucide, and deodorizer. For bacterial disinfection, heavy-duty cleaning, and sanitation of non-food contact surfaces. No added color or fragrance. Effective against MRSA, Hepatitis B and C, Avian Influenza and much more. Bloodborne pathogen compliant.

73430501 30501 1 gal. 4/cs.

73430505 30505 5 gal. 1/ea.

D. BROAD SPECTRUM DISINFECTANT CLEANER ZEP

Environmentally preferred, ready-to-use germicidal cleaner and deodorant. Effective on mold and mildew. Conforms to CDC blood borne pathogen procedures for environmental services. Kills Parvo, Tuberculosis, HIV-1, MRSA, and Staph.

75070031 R02301 1 qt. 12/cs.

75070032 R02324 1 gal. 4/cs.

E. LEMON DISINFECTANT DEODORIZING CLEANER ZEP

Concentrated quat-based cleaner and deodorizer. Cleans, disinfects and deodorizes in one easy step. Leaves a pleasant lemon fragrance.

75070029 R02201 1 qt. 12/cs.

75070030 R02224 1 gal. 4/cs.

F. LEMONGRASS SANITIZERS & CLEANERS W/PEROXIDE ZEP

Concentrated, all-purpose hard surface cleaner and sanitizer. Uses peroxide to clean and brighten. Safe for most hard surfaces.

75070033 R02424 1 gal. 4/cs.

75070034 R02435 5 gal. 1/ea.

RESTROOM CLEANERS

G. PRIME SOURCE® ARREST FOAMING RESTROOM CLEANER PRIME SOURCE®

Phosphoric acid cleaner for all restroom surfaces. Quick release foam clings to surface, rinses easily. Removes lime, scale and calcium deposits.

75004041 75004041 32 oz. 12/cs.

Restroom Cleaners



A. ENVIROPATROL® RESTROOM CLEANER CARROLL

Use as a high performance washroom general purpose cleaner. Concentrated cleaner for removal of soap scum, mildew, lime, water scale and rust deposits on porcelain, tile, ceramic tile and fiberglass surfaces. Safe for daily use on painted surfaces, porcelain, porcelain enamel, aluminum or stainless steel without etching or damaging them. Dilutes at 1 oz./gal. (1:128) for most applications. Green Seal® certified. Cold water effective.

30014402 44028 1 gal., Green Seal® 4/cs.



B. CLOROX® DISINFECTING BATHROOM CLEANERS CLOROX

Patented alkaline formula lifts soap scum off surfaces and breaks it down; requires less scrubbing. Patented bleach-free formula disinfects as it cleans, killing 99.9% of bathroom bacteria on hard, non-porous surfaces.

38387932 16930 30 oz. 9/cs.
38386038 16931 64 oz. 6/cs.

C. GREEN WORKS® NATURAL BATHROOM CLEANER CLOROX

A clean bathroom no longer has to equal harsh chemical fumes. The plant and mineral-based ingredients cut through soap scum, hard water and rust, leaving bathrooms naturally clean. In fact, our natural bathroom cleaner works as well as traditional cleaners. Safe on bathroom counters, sinks, tub, tiles and shower doors. DfE approved formula.

38380452 00452 24 oz. 12/cs.



D. SOFT SCRUB® DEEP CLEAN FOAMING CLEANSER DIAL

Thick foam works on contact to help remove tough stains, soap scum, lime, calcium and hard water deposits. Its fresh, clean scent is pleasant to use and leaves your bathroom smelling as clean as it looks.

12805022 15022 25.4 oz. 9/cs.

E. ANTIBACTERIAL SCRUBBING BUBBLES® BATHROOM CLEANER & WIPES DIVERSEY

Antibacterial foaming action thoroughly cleans, shines, sanitizes and deodorizes - without scrubbing. Attacks soap scum, hard water stains and dirt. Controls mildew. Kills common germs such as Staphylococcus aureus and E. coli. Won't scratch surfaces; leaves a brilliant shine. Not for use on acrylic, brass or natural marble surfaces. Multi-surface: Can be used to clean tubs, showers, basins, glazed ceramic tile, stainless steel, chrome, fixtures, fiberglass and glazed porcelain surfaces. Wipes are flushable.

15204308 94308 25 oz. 12/cs.
15202237 CB232237 Wipes, 28 ct., 3 1/4" x 8 1/2" 252/cs.



F. BATH MATE™ DISINFECTANT WASHROOM CLEANER DIVERSEY

Premium acid-free disinfectant washroom cleaner. EPA registered. Great for any facility including hospitals. Acid-free formula. Safe for most washable surfaces including polished marble. Strong, lingering, floral fragrance. Cleans away soap scum, body oils and lotions.

57080287 4305320 1 qt. 12/cs.



G. COMET® DISINFECTING BATHROOM CLEANERS PROCTER & GAMBLE

Dissolves tough soap scum and hard water stains. A patented, non-abrasive, full-strength spray cleaner for common restroom surfaces. Solvents and surfactants penetrate and dissolve tough soap scum and hard water stains without scrubbing. Product is a medical environment disinfectant that kills a broad spectrum of germs including Salmonella, Staphylococcus, Pseudomonas, and odor-causing bacteria including Proteus Mirabilis and E. coli. EPA Registration No. 3573-54.

16908174 01105 32 oz. 8/cs.
16900192 01106 1 gal. 3/cs.



H. LYSOL® BATHROOM CLEANER RECKITT BENCKISER

Foaming action removes soap scum and dirt. Cleans, shines and disinfects washable bathroom surfaces and fixtures.

58342569 02569 24 oz. 12/cs.



Restroom Cleaners/Tile Cleaners/Delimers



CHEMICALS

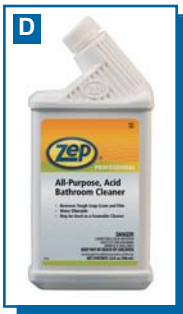

A. PROFESSIONAL LYSOL® HEAVY-DUTY BATHROOM CLEANER **RECKITT BENCKISER**
 Hospital disinfectant cleaner for all restroom cleaning needs. Deep cleaning action penetrates tough soils including body oils and soap scum. Cleans, disinfects and deodorizes with a fresh lime scent. Makes up to 32 gallons for general cleaning and disinfection (broad-spectrum disinfectant at 1:32). Makes up to 8 gallons for heavy-duty cleaning and hospital disinfection (hospital disinfection at 1:8). EPA Registration No. 675-54.
58344201 94201 1 gal. 4/cs.

B. VANI-SOL® BULK WASHROOM CLEANER **RECKITT BENCKISER**
 Versatile, ready-to-use, heavy-duty disinfectant cleaner. Cleans and shines with no harsh abrasives. Controls the growth of mold and mildew stains. Kills Staph and Strep germs and athlete's foot fungus. NSF Category Code C2.
58340294 00294 1 gal. 4/cs.

C. SIMPLE GREEN® CLEAN BUILDING™ BATHROOM CLEANER CONCENTRATE **SIMPLE GREEN**
 Specifically formulated for cleaning scale and scum types of soils typically found on hard bathroom surfaces. Pink color makes it easily identified when diluted into secondary containers. Safe to use on washable hard surfaces such as ceramic, glazed tile, Corian®, Formica, grout, faucets and fixtures, porcelain, and cured fiberglass. Non-toxic, biodegradable, non-caustic, and non-flammable. Makes 21 gallons of ready-to-use cleaner.
73431101 11101 1 gal., Green Seal® 2/cs.

D. ALL-PURPOSE ACID BATHROOM CLEANER **ZEP**
 Mineral acid formulation removes rust, scum, and hard water deposits from most bathroom surfaces including porcelain, ceramic, chrome, aluminum, and stainless steel. Safe and effective for use on toilet bowls, tile, sinks, showers, and bathroom fixtures. Water dilutable for large surface application. Fights odor causing bacteria. Can be applied with a foam gun. Angle neck bottle.
75070002 R00001 1 qt. 12/cs.

TILE CLEANERS/DELIMERS

E. PRIME SOURCE® DELIMER CLEANER **PRIME SOURCE®**
 Safely and effectively removes lime scale buildup. Non-flammable, biodegradable and rinse-free.
75004077 75004077 1 gal. 4/cs.

F. PRIME SOURCE® DESTROY SOAP SCUM REMOVER **PRIME SOURCE®**
 Use on shower stalls, terrazzo, tile, slate tubs and sinks. Chemically removes soap scum and hard water deposits.
75004016 75004016 1 gal. 4/cs.

G. PRIME SOURCE® SOFTY CRÈME CLEANER ND **PRIME SOURCE®**
 Bacteriostatic liquid for cleaning and polishing of metal, porcelain and other hard surfaces. High viscous; free rinsing. Extra soft abrasive cleaner for added safety.
75004045 75004045 32 oz. 12/cs.

H. PRIME SOURCE® SOFTY DISINFECTANT CRÈME CLEANER **PRIME SOURCE®**
 Bacteriostatic liquid for cleaning and polishing of metal, porcelain and other hard surfaces. High viscous; free rinsing. Extra soft abrasive cleaner for added safety.
75004035 75004035 32 oz. 12/cs.
76008503 76008503 946 mL 12/cs.

I. LIME OFF® HEAVY-DUTY DELIMER **CARROLL**
 Concentrated cleaner designed especially for dishwashing machines. Safely and effectively dissolves and removes lime scale build-up. Also removes lime scale and stain build-up on other kitchen equipment. Green color; no fragrance added; USDA A3.
30017528 37528 1 gal. 4/cs.

Tile Cleaners/Delimers/Bowl Cleaners



A. TILEX® CLOROX

Instant Mildew Remover

Cleans tile, grout, toilets and fiberglass instantly. Ready-to-use formula quickly removes mold and mildew both indoors and outdoors. EPA registered disinfectant and sanitizer for non-food contact surfaces.

38381100	01100	16 oz., Trigger Sprayer	12/cs.
38385600	35600	32 oz., Refill, RTU	9/cs.
38385605	35605	1 gal.	4/cs.

Soap Scum Remover

Dissolves soap scum and hard water stains without scrubbing.

38381126	01126	16 oz.	12/cs.
38385604	35604	32 oz.	9/cs.



B. EASY PAKS® DETERGENT/DISINFECTANT DIVERSEY

Offers convenient pre-measured packaging. Cleans, disinfects, deodorizes and controls mold and mildew.

15200102	90650	(90) 1/2 oz.	180/cs.
----------	-------	--------------	---------

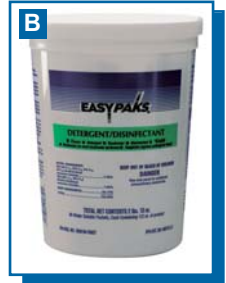

C. VANISH® TILE & GROUT CLEANER DIVERSEY

Institutional formula with special bleach ingredients that oxidize mildew stains, while detergents allow bleach to penetrate grout. Removes stains, soap scum, hard water spots. For all washable restroom hard surfaces, including tile, tubs, sinks, stainless steel. Spray, wipe, rinse—no scrubbing. English/Spanish labeling.

15200183	90156	32 oz.	6/cs.
----------	-------	--------	-------



D. LYSOL® BASIN, TUB & TILE CLEANER RECKITT BENCKISER

Removes soap scum and dirt. Foaming action. Cleans, shines and disinfects washable bathroom surfaces and fixtures.

58347660	77660	32 oz., Green Apple	12/cs.
----------	-------	---------------------	--------



E. PROFESSIONAL LYSOL® BASIN, TUB & TILE CLEANER RECKITT BENCKISER

Kills 99.9% of germs on hard, non-porous surfaces in 30 seconds. Removes soap scum, lime scale and hard water stains on restroom fixtures. Formula is tuberculocidal, virucidal, fungicidal and bactericidal. Contains no abrasives or bleach. Cleans, shines, disinfects and deodorizes. Prevents growth of damaging mold and mildew. Light citric acid formula. NSF Category Code C2, Reg. No. 129341.

58344685	04685	32 oz., Trigger Sprayer	12/cs.
----------	-------	-------------------------	--------



F. SIMPLE GREEN® LIME SCALE REMOVER SIMPLE GREEN

Strong enough to dissolve soap scum, hard water stains and mineral deposits, but mild enough to protect surfaces from damage that harsher cleaners can cause. Will not harm finishes, drains or pipes (including PVC). Wintergreen scent. Ready-to-use.

73430032	50032	32 oz., Trigger Sprayer	12/cs.
73430033	50128	1 gal.	6/cs.



G. CLINGING SHOWER & TILE CLEANER ZEP

Ready-to-use bathroom shower, tile and grout cleaner. Safe for use on most hard surfaces without dilution. Contains a powerful combination of effective surfactants and chlorine. Easily removes soap scum, hard water deposits and most stubborn mold and mildew stains from tile and grout. Thickened formulation to enhance performance on walls and vertical surfaces.

75070007	R00401	1 qt.	12/cs.
----------	--------	-------	--------



BOWL CLEANERS

H. PRIME SOURCE® BOWL SHEEN BOWL & BATHROOM CLEANER PRIME SOURCE®

Disinfectant cleaner that removes rust, calcium deposits and organic stains. 9.4% HCL disinfectant formula. EPA registered. *Check with us regarding availability/product registration status in your state.

75004037	75004037	32 oz.	12/cs.
----------	----------	--------	--------



Bowl Cleaners



A. PRIME SOURCE® KLEAN BOWL EMULSION BOWL CLEANER PRIME SOURCE®

Cleans, de-scales and deodorizes toilet bowls and urinals quickly, thoroughly and with minimum effort.

75004040	75004040	32 oz.	12/cs.
76008532	76008532	946 mL	12/cs.

B. PRIME SOURCE® LUSTER BOWL & BATHROOM CLEANER PRIME SOURCE®

Non-acid disinfectant cleaner that is thickened to cling to vertical surfaces. Kills HIV-1 (AIDS virus), TB, MRSA, VRSA and VRE. EPA registered.

76008535	76008535	946 mL	12/cs.
75004036	75004036	1 gal.	12/cs.

C. PORCELAIN & BOWL CLEANER CARROLL

9.6% HCl formula, hospital use disinfectant bowl cleaner. Removes scale and hard water deposits as it disinfects. Detergent system removes resistant stains. Fresh deodorizing mint fragrance.

30016223	76223	1 qt.	12/cs.
----------	-------	-------	--------

D. PRETTY POTTY® DISINFECTANT BOWL CLEANER CARROLL

20.3% HCl formula, hospital use bowl cleaner. Removes mineral deposits, lime scale and rust. Excellent in hard water/well water locales. Clear amber color changes to blue in use; mint fragrance.

30016323	76323	1 qt.	12/cs.
----------	-------	-------	--------

E. CLOROX® CLOROX

Automatic Bowl Cleaner

Deodorizes and keeps bowl fresh and clean for up to four months.

38381261	00946	3 1/2 oz.	6/cs.
38380940	00940	3 1/2 oz.	12/cs.

Toilet Bowl Cleaner

Contains the power of bleach to clean toilets and remove stains. Cleans and leaves toilet bowls sanitary. Thick gel clings to bowl.

38389031	00031	24 oz., RTU	12/cs.
----------	-------	-------------	--------

F. GREEN WORKS® NATURAL TOILET BOWL CLEANER CLOROX

Works on tough stains, rust, mineral deposits and hard water. Angled neck design makes cleaning under the rim easier. Since it's made with plant and mineral-based ingredients, it's better for the environment. Best of all, it works just as well as traditional cleaners. No bleach or phosphorous. DfE approved formula.

38380451	00451	24 oz., RTU	12/cs.
----------	-------	-------------	--------

G. AJAX® EPA DISINFECTANT BOWL CLEANER COLGATE-PALMOLIVE

Ready-to-use one-step cleaning, disinfecting and deodorizing. Effective soil removal. Eliminates rust, lime and uric acid deposits. EPA Registration No. 8155-6-4582.

11904602	04601	32 oz.	12/cs.
----------	-------	--------	--------

H. CREW® DIVERSEY

Clinging Disinfectant Toilet Bowl Cleaner

Clings to vertical surfaces. Cleans, disinfects and deodorizes. Effectively removes build-ups of rust, stains, lime scale, hard water deposits, uric acid salts and other minerals. EPA registered.

15200010	4578	32 oz., 9.25% HCl Formula, RTU	12/cs.
----------	------	--------------------------------	--------

Non-Acid Bowl Cleaner

Non-acid bowl cleaner for daily use in toilet bowls and on all washable restroom surfaces. Appealing Fresh™ fragrance. EPA registered, DIN and PCPA registered.

15204996	4996	32 oz., RTU	12/cs.
----------	------	-------------	--------

I. EASY PAKS® TOILET BOWL CLEANER DIVERSEY

Specially-formulated enzyme/detergent blend quickly dissolves in water to attack organic waste and urinary salts without harsh acids or caustics. Will not harm plumbing. Pleasant scent. NSF C1 Registered.

15200103	90652	(90) 1/2 oz. Packets	1/ea.
----------	-------	----------------------	-------

Bowl Cleaners



A. NATURE'S SOURCE™ TOILET BOWL CLEANER DIVERSEY

A thick, extended-action formula from the makers of Scrubbing Bubbles®. Clings under the rim, breaking down organic stains and hard-water deposits naturally, leaving nothing behind but a fresh scent. Plus, its plant-based cleaners are biodegradable. DfE approved formula.
15200445 CB701900 24 oz. 8/cs.



B. VANISH® DIVERSEY

Non-Acid Bowl & Bathroom Cleaner II

Cleans and disinfects in one step. Powerful quaternary detergent thickened liquid for toilet bowls, urinals and general purpose bathroom cleaning and disinfecting. Bactericidal, virucidal, odor neutralizer and deodorizer. Disinfects against the following organisms on hard, nonporous environmental surfaces: Staphylococcus aureus, Pseudomonas aeruginosa, Salmonella enterica. Hospital-grade. Evaluated and found to be effective in the presence of 10% serum against the AIDS virus on inanimate surfaces with one minute contact time.

15200148 90158 32 oz., RTU 6/cs.

Thick Liquid Disinfectant Bowl Cleaner

Disinfects in one minute. 9.25% hydrochloric acid formula is extra thick to cling to the sides of the bowl. Cleans, disinfects and deodorizes toilet bowls and urinals. Dissolves limescale and uric acid deposits and stains. One-step, hospital-grade cleaner/disinfectant. Kills Staphylococcus aureus, Salmonella choleraesuis, Pseudomonas aeruginosa, E. coli 0157:H7, Methicillin Resistant Staphylococcus aureus (MRSA), HIV-1 (AIDS virus), Hepatitis A Virus, Herpes Simplex 1 and 2.

15200238 90157 32 oz. 12/cs.



C. CLING™ 2 IN 1 CLIP-ON TOILET BOWL DEODORIZERS & CLEANERS RECKITT BENCKISER

Continuous fragrancing gel plus powerful cleaning block. Powerful cleaning with every flush.
58347136 77136 1.27 oz., Citrus & Tangerine 12/cs.
58340004 77137 1.27 oz., Spring Waterfall 12/cs.



D. LYSOL® DEEP REACH TOILET BOWL CLEANER RECKITT BENCKISER

Kills 99.9% of germs in the bowl and the mouth trap when used as directed. Thick formula coats the entire bowl. Removes lime scale through the 'S' bend. Use regularly to prevent build-up of mineral deposits.

58348008 80088 24 oz. 12/cs.



E. PROFESSIONAL LYSOL® DISINFECTANT TOILET BOWL CLEANER RECKITT BENCKISER

Thick acid formula dissolves stubborn rust stains and mineral stains, but will not harm plumbing or septic systems. Kills Staph, Pseudomonas, E. coli, HIV-1 (AIDS virus) and other harmful germs on hard, non-porous surfaces. Wintergreen scent in a no-waste, angle neck bottle. Cleans, disinfects and deodorizes. EPA Registration No: 777-81-675.

58344278 74278 32 oz. 12/cs.



F. VANI-SOL® HIGH ACID BOWL CLEANSER RECKITT BENCKISER

A powerful liquid toilet bowl cleaner and deodorizer. For use in restrooms with heavy traffic, hard water, or difficult soils. Powerful 23% hydrochloric acid formula. Dissolves even the toughest stains, including built-up lime deposits, hard water scale, and rust stains. Will not harm septic tanks. Contains a metal corrosion inhibitor. Angle neck for easier application.

58342212 02212 32 oz. 12/cs.



G. BOWL CLEANER W/PEROXIDE ZEP

Mildly acidic blend of peroxide and detergents easily removes scum, scale, and mineral deposits. Leaves behind a pleasant lemongrass fragrance.

75070008 R00501 1 qt. 12/cs.

H. DISINFECTANT ACID BOWL CLEANER ZEP

Disinfects toilet bowls while quickly removing rust, scum, scale, and stains. Thickened formula for greater contact time. Works in seconds and easily rinses away. Contains no fuming acids for a safer and more pleasant work environment.

75070003 R00101 1 qt. 12/cs.



Bowl Cleaners/Drain Treatments



CHEMICALS



A. NON-ACID DEODORIZER & TOILET BOWL CLEANER **ZEP**
 Environmentally preferred, non-acidic cleaner and deodorizer, removes scale, stains, and scum. Use on toilet bowls, tiles, sinks, showers, and bathroom fixtures.
 75070006 R00301 1 qt. 12/cs.

DRAIN TREATMENTS

B. PREMIUM PLUS ULTRA ENZYME DRAIN CLEANER **PRIME SOURCE®**
 For use in drains, grease traps and collection systems. Safely digests fat, grease, oil, protein and starch.
 75004588 75004588 5 gal. 1/ea.

C. PRIME SOURCE® PIPE DREAM BIOENZYMATIC DEODORIZER/SPOTTER/DIGESTER **PRIME SOURCE®**
 Organically removes spots from carpet and fabrics. Multi-purpose; blended with multiple, non-pathogenic bacterial strains.
 75004070 75004070 1 gal. 4/cs.
 75004071 75004071 5 gal. 1/ea.

D. ALKA-LION® DRAIN OPENER MAINTAINER **CARROLL**
 Unclog drains and pipes with this professional strength alkaline concentrate. This product was designed to unclog drains in foodservice and other high volume operations. It is fast-acting and effective in removing alkaline sensitive blockages. Use this powerful product with care. Do not allow aluminum contact.
 30010320 39123 1 qt. 12/cs.

E. LIQUID-PLUMR® DRAIN OPENER **CLOROX**
 Professional Strength Liquid-Plumr® clears completely clogged drains by delivering more active ingredients to the clog than other drain openers.
 38380242 00242 1 qt. 9/cs.

F. LIQUID-PLUMR® HEAVY-DUTY CLOG OPENER **CLOROX**
 Formula goes straight to the clog. Active ingredients dissolve hair, food soils, and create free flowing drains. Ready-to-use formula cuts mixing time to save labor costs. Safe for disposals, septic tanks, and plastic pipes.
 38385286 35286 80 oz. 6/cs.

G. DRANO® LIQUID CLOG REMOVER **DIVERSEY**
 Contains a special ingredient to protect pipes from corrosion. Safe for plastic, PVC, metal pipes, garbage disposal and septic systems. Won't harm pipes even when used overnight. Does not contain phosphorous. Starts working to break down clogs on contact. After 15 to 30 minutes, clogs are substantially minimized or dissolved. A final blast of hot water flushes away what's left of the clog.
 15201169 CB000169 32 oz. 12/cs.

H. DRANO® PROFESSIONAL STRENGTH DRAIN CLEANER **DIVERSEY**
 Specially formulated to pour through standing water, powerful Drano products won't harm plastic pipes, disposals or septic tanks. Institutional formula is a 32% caustic formula that attacks tough, grease-based clogs. Ready-to-use.
 15200147 90485 32 oz. 12/cs.

I. ALKALINE DRAIN OPENER **ZEP**
 Concentrated, ready-to-use alkaline drain opener. Ideal for both corrective and preventive maintenance. Suitable for use in kitchen, bathrooms and commercial drains.
 75070037 R02701 1 qt. 12/cs.
 75070038 R02735 5 gal. 1/ea.

J. BIOLOGICAL DRAIN MAINTAINER **ZEP**
 Environmentally preferred drain maintenance product powered by enzymatic activity. Safe for use in septic systems to keep drains free flowing. A biological solution for safe, routine maintenance.
 75070036 R02635 5 gal. 1/ea.

Deodorant Blocks/Rim Cages/Urinal Screens



DEODORANT BLOCKS/RIM CAGES

A. HEALTH GARDS® HOSPECO

Para Toilet Bowl Block

Universal fit for all toilets. Blocks with deluxe hanger.

14508411 08411 4 oz., Cherry 144/cs.

Para Urinal Blocks

Non-toxic biodegradable blocks.

145063115 06311 Corrugated Shipper, 3 oz., Cherry 12/cs.

145064115 06411 Corrugated Shipper, 4 oz., Cherry 12/cs.

14506411 06411 Corrugated Shipper, 4 oz., Cherry 144/cs.

14506902 06901 Sleeve, 4 oz., Cherry 144/cs.

Stick Up Deodorant Blocks

Stick up deodorant blocks.

14500213 05902 9 oz., Apple 12/cs.

14505905 05905 9 oz., Citrus 12/cs.

Toilet Rim Cage

Cleans and deodorizes toilet bowls for up to 30 days. Non-para formulation, tints water blue with each flush.

14500162 02901 Cherry 12/cs.

Toss In Blocks

Non-para toss in blocks.

14500017 04901 4 oz., Cherry 12/cs.

14500016 04905 4 oz., Citrus 12/cs.

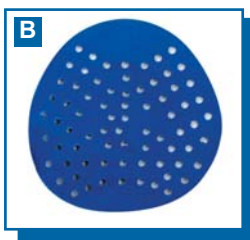

URINAL SCREENS

B. DEOD-O-SCREEN CCP

Vinyl urinal screen has 30 days of built-in deodorant. Universal shape fits most urinals.

Disposable poly-glove included. Each screen is individually packaged.

276021645 1641 Blue (Floral) 12/cs.

C. KLEEN SCREEN URINAL SCREEN CCP

4 oz. enzymatic deodorant block contains surfactants and chelating agents to clean and deodorize for 30 days (up to 2,000 flushes). Coloring agents are released with each flush so you know that it's working. Increased ventilation reduces potential splash back and flexible screen traps more debris to prevent costly drain clogs.

27600793 1654 4 oz., 7¹/₈" x 7³/₄" x 1¹/₄", Red/Strawberry 12/cs.



D. CHLOROSCENT™ URINAL SCREEN HOSPECO

Screen with bleach block. Para should not sit in a dry urinal because it dissipates in air and non-para should not sit in standing water. Chloroscent can be used in either environment.

The bleach assists in the breakdown of uric salts, leaving the base and the throat of the urinal clean and odor-free. Lasts twice as long as para or non-para; up to 60 days.

Acceptable for use with acid bowl cleaners.

14501664 01664 60 Days 12/cs.

E. CHLOROSCREEN™ DISSOLVABLE URINAL SCREEN HOSPECO

Prevents debris from being flushed down the urinal. Increases cleanliness, eliminates odor, leaves a clean scent, and reduces maintenance time. Lasts up to 60 days. Contains no dyes to stain urinals. Naturally dispenses bleach in the water every time the urinal is flushed.

Dissolves 100%. No removal is required. Individually wrapped.

14501661 01661 60 Days 24/cs.



F. HEALTH GARDS® HOSPECO

Urinal Screens w/Non-Para Block

Clean and deodorize for up to 1,500 flushes. Non-staining, non-toxic, biodegradable block.

Prevents drain clog while deodorizing. Exclusive patented no-splash design.

14500164 01901 Cherry 12/cs.

14501905 01905 Citrus 12/cs.

Urinal Screen w/Para Block

Deodorizes for up to 30 days. Prevents drain clogs. Cost effective.

14501991 01991 4 oz., Cherry 12/cs.

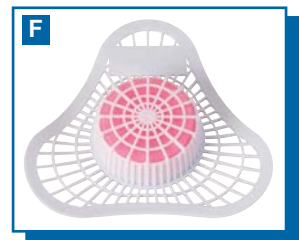

Urinal Screens/Liquid Deodorants

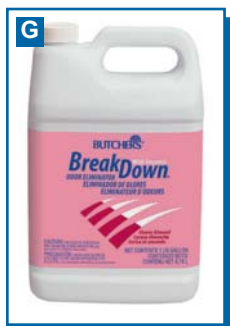
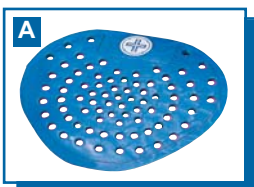

A. HEALTH GARDS® HOSPECO

Vinyl Urinal Screens

Odor control lasts for at least 30 days. Helps to eliminate odors while preventing clogging. Flexible to fit all urinals.

14503907	03907	Bubble Gum (Dark Blue)	12/cs.
14503902	03902	Cherry (Green)	12/cs.
14503901	03901	Cherry (Red)	12/cs.
14503905	03905	Citrus (White)	12/cs.
14503904	03904	Mint (Blue)	12/cs.

LIQUID DEODORANTS

B. PRIME SOURCE® DEODORANTS PRIME SOURCE®

Economical, versatile, may be used as a space spray or in detergents.

75004115	75004115	1 gal., Cherry Blossom	4/cs.
75004116	75004116	1 gal., Lemon	4/cs.
75000040	75000040	55 gal., Cherry Blossom	1/ea.

C. HAPPY® MALODOR COUNTERACTANT CARROLL

Chemically neutralizes odor causing molecules with no overpowering scent. Can be used on fabrics without staining or residue at proper dilution. Add to cleaning products to eliminate odors and improve cleaning. Light floral fragrance.

30010310	41723	1 qt.	12/cs.
30010311	41728	1 gal.	4/cs.

D. HEAVY-DUTY CHEMICAL DEODORANT CARROLL

Chemically reacts with odors to eliminate them, not just cover them up. Highly concentrated, water soluble formula. Excellent for use in portable toilets, aircraft toilets, campers and boats. Dark blue; pleasant fragrance in use; USDA C1.

30010312	41828	1 gal., Dark Blue	4/cs.
----------	-------	-------------------	-------

E. RENUZIT® SUPER ODOR NEUTRALIZER® DIAL

Eliminates the toughest odors, including tobacco smoke, bathroom and pet odors. Patented odor neutralization/elimination technology. Fresh, clean, long-lasting fragrance.

12800007	36003	13 oz., After The Rain®	6/cs.
12808777	36055	32 oz., Commercial RTU	6/cs.

F. GOOD SENSE® ODOR COUNTERACTANT DIVERSEY

Ready-to-use spray odor counteractants help neutralize tobacco, mold, mildew and urine surface/airborne odors. Uses J-Lift™ technology to lift fragrance into the air.

15204437	4437	32 oz., Outdoor Fresh™	12/cs.
----------	------	------------------------	--------

G. BREAKDOWN® ENZYME ODOR ELIMINATOR DIVERSEY

Contains enzymes and odor counteractants that combat the source of odors. Effective against a wide range of odors in carpets, washrooms, trash cans and more. Long-lasting pleasant fragrance.

57081115	4291110	1 gal., Fresh	4/cs.
----------	---------	---------------	-------

H. SUMA® DUMPSTER FRESH™ DIVERSEY

Noticeably reduces the smell of garbage. Three-part treatment offers strong cleaner, "knock down" fragrance and bioactive nonpathogenic (non-disease causing) formula that quickly goes to work creating enzymes to digest grease and other organic soils. Applied bacteria keep odors from coming back. Requires no scrubbing, just spray and walk away.

15206359	4266359	32 oz.	1/ea.
----------	---------	--------	-------

I. FEBREZE® FABRIC REFRESHER & ODOR ELIMINATOR PROCTER & GAMBLE

Unlike cover-up, Febreze's unique odor cleaning formula is designed to penetrate deep into the fabrics to eliminate odors where they get trapped. This one-step odor cleaning system eliminates common odors such as pet, smoke, cooking and musty smells. Safe to use on virtually all types of fabrics.

16909756	03259	32 oz., Trigger Sprayer	8/cs.
16903258	05150	33.8 oz., Trigger Sprayer	6/cs.
16901828	11828	1 gal.	3/cs.
16907563	36551	1 gal., Concentrate	2/cs.
16903032	33032	1 gal., Deep Penetrating	3/cs.

Liquid & Aerosol Deodorants



A. PROFESSIONAL AIR WICK®

LIQUID DEODORIZER

RECKITT BENCKISER

Freshens the air and eliminates odors. Use 1:10 to deodorize and 1:24 for economic, everyday freshening. Helps control cigarette and cigar smoke, mold and mildew, gym, drain, bathroom and cooking odors, as well as odors from incontinent areas. NSF Category Code C1: Reg. No. 129365.

58346732 06732 1 gal., Clean Breeze, Concentrate 4/cs.



B. Z-FRESH ODOR NEUTRALIZERS

ZEP

Environmentally preferred, highly effective odor neutralizer. Chemically eliminates the source of odors and replaces them with a pleasant clean fragrance.

75070022 R01601 1 qt., Breeze 12/cs.

75070025 R01901 1 qt., Potpourri 12/cs.

75070026 R02001 1 qt., Subdue 12/cs.

AEROSOL DEODORANTS

C. PRIME SOURCE® DRY AIR

FRESHENER AEROSOLS

PRIME SOURCE®

Dry air freshener and odor neutralizer. Eliminates tough odors, including tobacco.

75004101 75004101 10 oz., Cinnamon Stick 12/cs.

75004102 75004102 10 oz., Dry Breeze Bouquet 12/cs.

75004100 75004100 10 oz., Mango Magic 12/cs.

75004106 75004106 17 oz., Nice Air Lemon 12/cs.

75004105 75004105 17 oz., Nice Air Spice 12/cs.

75004104 75004104 10 oz., Powder Puff 12/cs.

75004099 75004099 10 oz., Tropical Flower 12/cs.

75004098 75004098 10 oz., Vanilla Caramel 12/cs.



D. GLADE® AIR FRESHENERS

DIVERSEY

Eliminates strong persistent odors with clean scent—not a heavy perfume. Use in commercial, industrial or institutional buildings. Trilingual packaging.

15200041 94780 14 oz., Country Garden® Potpourri 12/cs.

15200030 94787 14 oz., Smoke Odor Eliminator 12/cs.

15200140 94782 14 oz., Super Fresh® 12/cs.



E. GOOD SENSE® AEROSOL AIR FRESHENER

DIVERSEY

Works fast, leaves a gentle, fresh fragrance. Aerosols are CFC-free.

15207126 4774 13 oz., Tuscan Garden™ 12/cs.



F. OUST®

DIVERSEY

Air Sanitizers

Snuffs out odors caused by bacteria before you smell them. Kills odor-causing bacteria in the air.

15200174 CB028684 10 oz., Citrus Scent 12/cs.

15200173 CB028653 10 oz., Outdoor Scent 12/cs.

Surface Disinfectant & Air Sanitizers

Surface disinfectant and air sanitizer in one. Disinfects in 5 minutes and sanitizes in 30 seconds on hard, non-porous surfaces. Kills greater than 99.9% of germs, bacteria, viruses and fungi on hard, non-porous surfaces. Helps reduce the number of airborne bacteria leaving the treated area smelling clean and fresh. Aerosol spray is an easy-to-use delivery system for sanitizing air and disinfecting surfaces.

15200328 CB179058 12 oz., Clean Scent 12/cs.

15208571 CB168571 12 oz., Outdoor Scent 12/cs.



G. FEBREZE® AIR EFFECTS AIR REFRESHERS

PROCTER & GAMBLE

Formulated to actually eliminate odors in the air instead of just masking them. Clears away stale, stifling odors while leaving a fresh, clean scent behind.

16901649 45535 9.7 oz., Meadows & Rain 9/cs.

16901650 45536 9.7 oz., Spring & Renewal 9/cs.



H. AIR WICK® 2 IN 1 AEROSOL

AIR FRESHENERS

RECKITT BENCKISER

Helps remove tough odors and leaves a light, clean fragrance.

58345762 05762 8 oz., Lavender & Chamomile 12/cs.

58347895 77895 8 oz., Papaya & Mango 12/cs.



Aerosol & Scented Oil Deodorants/Systems



A. LYSOL® NEUTRA AIR® AIR SANITIZERS RECKITT BENCKISER

Lysol® Neutra Air® sanitizing spray destroys bacterial odors by sanitizing the air and attacking odors at their source by killing 99.9% of odor-causing bacteria.

58346940	76940	10 oz., Citrus	12/cs.
58346938	76938	10 oz., Fresh	12/cs.
58349196	79196	10 oz., Morning Dew	12/cs.

B. SMOKE & ODOR NEUTRALIZER ZEP

Highly effective aerosol odor counteractant. Safe for use on fabrics. Formulated to neutralize and eliminate smoke related odors. Leaves a pleasant fresh fragrance.

75070024	R01801	20 oz.	12/cs.
----------	--------	--------	--------

SCENTED OIL DEODORANTS

C. AIR WICK® X-PRESS™ SCENTED OIL WARMER RECKITT BENCKISER

Provides continuous fragrance all day. Fan circulates additional fragrance when X-Press™ button is pushed. Five continuous settings. Fits all current Air Wick scented oil refills.

58348664	78664	1 Unit	6/cs.
----------	-------	--------	-------

DEODORANT SYSTEMS - AEROSOL

D. PRIME SOURCE® METERED DEODORANT SPRAY DISPENSER & REFILLS PRIME SOURCE®

Dispenser

Attractive cabinet. Adjustable spray intervals. Effective control for up to 6,000 cu. ft.

75004095	75004095	6 1/2 oz.	1/ea.
----------	----------	-----------	-------

Refills

Neutralizes and deodorizes. Up to 3,000 metered sprays per can. Effective on smoke and restroom odors.

75004111	75004111	6 3/4 oz., Apple	12/cs.
75004114	75004114	6 3/4 oz., Baby Powder	12/cs.
75004113	75004113	6 3/4 oz., Cherry Berry	12/cs.
75004108	75004108	6 3/4 oz., Cinnamon	12/cs.
75004123	75004123	6 3/4 oz., Citrus Sunburst	12/cs.
75004112	75004112	6 3/4 oz., Fresh Linen	12/cs.
75004107	75004107	6 3/4 oz., Lemon Drop	12/cs.
75004120	75004120	6 3/4 oz., Mistic Mango	12/cs.
75004121	75004121	6 3/4 oz., Ocean Mist	12/cs.
75004122	75004122	6 3/4 oz., Something Peachy	12/cs.
75004110	75004110	6 3/4 oz., Vanilla	12/cs.
75004109	75004109	6 3/4 oz., Wildflower	12/cs.
760007631	76000763	369 g, Citrus Sunburst	1/ea.
76000763	76000763	369 g, Citrus Sunburst	12/cs.

E. KLEEN TECH™ AIR FRESHENER DISPENSER & REFILLS CCP

Dispenser

Effective in rooms up to 6,000 cubic feet for 30 days. Key or keyless lock. "D" cell batteries not included. Deluxe features a real time clock, from 1 to 60 minute spray intervals, programmable start and stop, On/Off switch and LED refill/battery reminder. Fits most metered aerosols.

27600156	1190	9 1/4" x 3 1/2" x 3 1/2", White	6/cs.
----------	------	---------------------------------	-------

Refills

Metered spray refill for Kleen Tech dispenser. Superior bloom and suspension time. Dry type spray uses no ozone depleters and contains less than 30% total VOC content. Effective odor neutralizer without heavy fragrances.

27601184	1184	7 oz., Baby Powder	12/cs.
27602187	1187	7 oz., Cinnamon	12/cs.
27601183	1183	7 oz., Garden Apple	12/cs.
27602186	1186	7 oz., Lemon	12/cs.
27601182	1182	7 oz., Nautical Mist	12/cs.
27602185	1185	7 oz., Odor Neutralizer	12/cs.
27601162	1186	7 oz., Orange	12/cs.

Aerosol Systems



A. GOOD SENSE® AUTOMATIC SPRAY SYSTEM DISPENSER & CARTRIDGE DIVERSEY

A simple and efficient solution to on-going odor control needs. Patented concentrated aerosol technology delivers a dry and fine mist resulting in long-lasting action against malodors.

15204806	4806	Dispenser, White	4/cs.
15204809	4809	19 mL, Fresh, Cartridge	12/cs.

B. HEALTH GARDS® STRATUS® 3 SLIMLINE METERED AEROSOL DISPENSER & REFILLS HOSPECO

Dispenser

Designed with smaller wall footprint. Polypropylene construction will not break down or melt away from the overspray of acetone-based formulations. 24-hour/day (light sensing) modes of operation. Wall mount is easy to refill. Spray timer adjusts to release aerosol at 5, 10, 15 or 20-minute intervals.

14507531	07531	6000 cu. ft.	1/ea.
----------	-------	--------------	-------

Refills

Contains Neutrex®, an odor-fighting compound that actually seeks out malodors for the purpose of eliminating the source. Universal fit spray actuator on aerosol can fits mist cabinets. Each aerosol provides up to 3,400 metered sprays. Non-chlorinated aerosols are VOC compliant.

14500062	07906	7 oz., Cinnamon Spice	12/cs.
14507918	07918	7 oz., Fresh Linen	12/cs.

C. AIR WICK® FRESHMATIC® AIR FRESHENER KITS & REFILLS RECKITT BENCKISER

Kits

Delivers continuous room-freshening for up to 60 days. FreshMatic®'s subtle, time-released fragrances are set to ensure an always-pleasant, always-welcoming atmosphere. Starter kit is complete with everything you need, including the automatic unit, fragrance spray and (2) AA batteries.

58349782	79782	Fresh Waters	4/cs.
58348620	78620	Papaya & Mango	4/cs.
58347964	77964	Sparkling Citrus	4/cs.

Refills

Delivers continuous room-freshening for up to 60 days. Fits Freshmatic® Ultra and Freshmatic® Ultra I-Motion™.

58349553	79553	Fresh Waters	6/cs.
58340028	78283	Harvest Spice®	6/cs.
58347961	77961	Lavender	6/cs.
58348621	78621	Papaya & Mango	6/cs.
58347965	77965	Sparkling Citrus®	6/cs.

D. AIR WICK® FRESHMATIC® COMPACT I-MOTION™ RECKITT BENCKISER

Easy and convenient, features three time settings: set to spray every 7½, 15, or 30 minutes. Battery-powered timer-switch. X-Press® button for an extra boost of fragrance as needed. Great for any size room. Lasts up to 60 days (on 30 minute setting). Kit contains: Automatic Unit, Fragrance Spray, (3) Batteries.

58349902	79902	Aqua Essences Fresh Waters, Starter Kit	6/cs.
58349904	79904	Aqua Essences Fresh Waters, Refill Only	10/cs.
58349906	79906	Citrus Delight, Refill Only	10/cs.
58349907	79907	Lavender Fields, Refill Only	10/cs.
58349908	79908	Fruit Medley, Refill Only	10/cs.

E. AIR WICK® FRESHMATIC® ULTRA AIR FRESHENER KIT RECKITT BENCKISER

Delivers continuous room-freshening for up to 60 days. FreshMatic®'s subtle, time-released fragrances are set to ensure an always-pleasant, always-welcoming atmosphere. Starter kit is complete with everything you need, including the automatic unit, fragrance spray and (2) AA batteries.

58347960	77960	Lavender	4/cs.
----------	-------	----------	-------



CHEMICALS

Aerosol & Gel/Solid Systems



A. LYSOL® NEUTRA AIR® STARTER KIT RECKITT BENCKISER

From the makers of Lysol. Plugs into electrical outlet, leaves the second outlet-free. Patented odor-eliminating technology removes airborne odors caused by germs. Refreshes the air by leaving a crisp, clean fragrance. Provides continuous, consistent action for up to 60 days. Kit includes adjustable electric activator plus one 0.71 oz. bottle of deodorizer.

58348526 77914 Citrus, Refill Only 8/cs.



B. NEUTRA AIR® FRESHMATIC KIT W/BOOST TECHNOLOGY® RECKITT BENCKISER

Neutralizes tough odors in the air from odor-causing bacteria including smoke, bathroom, pet and mildew odors. Refreshes the air, leaving a clean, pleasant fragrance. Automatically neutralizes odors in the air from odor-causing bacteria including smoke, bathroom, food and pet odors. Three time settings - 9, 18 or 36 minutes. Keeps your bathroom, kitchen or any room smelling fresh and clean. Refill lasts for up to 60 days. X-Press® Boost Button delivers an extra boost of freshness.

58349830 79830 Starter Kit, Fresh Scent 4/cs.

58349831 79831 Refill Only, Fresh Scent 6/cs.



C. SEBREEZE® AEROSOL DISPENSER & CANISTERS RUBBERMAID

Dispenser

Easy to operate with no programming required. Accommodates 3000 and 9000 Series fragrance canisters. Keyless locking cabinet. Consistently metered sprays every 15 minutes.

17705137 5137 Off White 6/cs.

9000 Series Canisters

Effective odor control for continuous customer satisfaction. Proprietary odor neutralizing technology for odor elimination. Customer preferred, clean, fresh fragrances. Meets State of California less than 30% VOC requirements. Effective coverage of up to 6,000 cubic feet. Fits #5137 and #5169 units.

17705139 5139 Citrus Breeze 12/cs.

17705138 5138 Spring Garden 12/cs.



D. Z-MIST DISPENSER & COUNTERACTANTS ZEP

Dispensers

Automatically releases an exact amount of odor or insect control-based on your settings to keep your environment odor or insect-free. Made from high-impact ABS plastic. Mounts to any wall. For use with any Z-Mist aerosol

750700391 R02801 White 1/ea.

Counteractants

Highly-concentrated, metered odor counteractant. Treats up to 6,000 cubic feet of closed air space with 3,000 sprays per can providing approximately 30 days coverage. Designed for use with the Zep Professional Z-Mist dispenser.

75070021 R01501 6 1/2 oz., Clean Air 12/cs.

75070023 R01701 6 1/2 oz., Fresh Cinnamon 12/cs.

75070019 R01301 6 1/2 oz., Fresh Green Apple 12/cs.

75070020 R01401 6 1/2 oz., Fresh Vanilla 12/cs.

DEODORANT SYSTEMS - GEL/SOLID



E. KLEEN AIRE WICK AIR FRESHENER REFILLS CCP

A long-lasting economical way to control odors. Designed to freshen 1,500 cubic feet for 45 to 60 days. Non-spill 1 1/2 oz. bottle with adjustable wick is VOC compliant. Mini cabinet houses freshener and provides a professional appearance.

27600153 153 1 1/2 oz., Cherry 72/cs.

27601154 154 1 1/2 oz., Lemon 72/cs.



F. RENUZIT® SUPER ODOR KILLER DIAL

Continuous, long-lasting air freshening lasts up to thirty days. Allows you to adjust the level of freshening power.

12803659 03659 7 1/2 oz., Super Odor Killer® 12/cs.

G. GLADE PLUG-INS® AIR FRESHENER DIVERSEY

Long-lasting, refillable air fresheners that plug into any 110 volt electric outlet. Use only as much current as a night light to freshen air for up to 45 days.

15205347 CB153478 Tropical Mist, w/Extra Outlet 6/cs.

15204923 CB006965 Tropical Mist, 3 Pack Refills Only 36/cs.

Gel/Solid Systems/Chemical Systems



A. GOOD SENSE® 30-DAY AIR FRESHENING SYSTEM DIVERSEY

Battery-free, intuitively-designed air freshener system designed to control odors in restrooms and other areas with adequate airflow.

15207005 3357005 Fresh Refill Pads 12/cs.



B. KIMCARE® CONTINUOUS AIR FRESHENER SYSTEM REFILLS KIMBERLY-CLARK

The sensible way to keep your restrooms smelling fresh. There are no batteries to replace, it's completely self-powered, and it provides continuous air freshening in your restroom 24 hours a day, 7 days a week. Each cartridge lasts for 60 days. Dispenser is easy-to-use and, unlike other air freshening systems, does not require programming.

15401067 91067 Citrus, Refill 6/cs.
15400072 91072 Ocean, Refill 6/cs.



C. AIR WICK® DECOSPHERE™ AIR FRESHENERS RECKITT BENCKISER

Fresh fragrance lasts for six weeks. Air freshener with a modern look. Strength of fragrance is easily adjustable.

58347869 77869 Calming Magnolia & Cherry Blossom 6/cs.
58347340 77340 Linen & Cotton Flower 6/cs.
58346755 76755 Papaya & Mango 6/cs.
58346754 76754 Soothing Jasmine & Kiwi 6/cs.



D. SEBREEZE® AUTOMATIC ODOR CONTROL SYSTEM RUBBERMAID Dispenser

Long-lasting effective odor control. Use as a wall-mounted or free standing unit. Delivers 24 hour odor control for a full 30 days. Air flow vents and battery operated fan disperse fragrance continuously.

17705115 5114 7¼"H x 3⅝"L x 3½"W, Off White 6/cs.

Fragrance Cassettes

Patented fragrance cassette canister includes battery for easy, one step replacement. Delivers 24 hour odor control for a full 30 days.

17700207 9C84 Citrus Breeze 6/cs.
17709015 5119 Jungle Rain (Floral) 6/cs.
17709060 9C87 Lavender Bouquet 6/cs.



E. SEBREEZE® ODOR ABSORBING GEL FRAGRANCE CASSETTE RUBBERMAID

Gel absorbs odors in the air and converts them to non-toxic, odorless compounds. Includes battery for easy, one step replacement. 24 hour odor control for a full 30 days.

17700200 9C94 Lemon-Lime, For 9C90 Fan System 6/cs.



CHEMICAL DILUTION SYSTEMS

F. ACCUMIX™ CHEMICAL CONCENTRATE DIVERSEY

AccuMix™ is the unique cleaning system with a built-in accurate measuring spout. Simply loosen the cap, squeeze and pour the concentrate into a bucket, scrubber tank or Accutainer. Get the right proportions every time. No measuring hassles, less product waste. The accurate solution to cleaner dilution.

15204271 4271 32 oz., Stench & Stain Digester, 1:128 6/cs.





Chemical Systems

CHEMICALS



A. COMMAND CENTER® CHEMICAL CONCENTRATES DIVERSEY

Products are color and number coded for easy identification. This identification system is used on the chemical concentrate, on the button label, on hose labels, on secondary labels and on silk screened spray bottles. No Chemical Contact System. 1½ gal.

57084150	<i>4044150</i>	#1 Speedball® Heavy-Duty Spray Cleaner, 1:6	2/cs.
57083920	<i>3323964</i>	#2 Look™ Glass & Multi-Purpose Cleaner	2/cs.
57088150	<i>4038150</i>	#4 Sundance® Neutral Floor Cleaner, 1:256	2/cs.
57083967	<i>3323981</i>	#5 Rainsdance™ Low Foam Neutral Floor Cleaner, 1:256	2/cs.
57083947	<i>4304150</i>	#16 Bath Mate™ Premium Acid-Free Disinfectant Washroom Cleaner, 1:12	2/cs.
57083971	<i>3318102</i>	#20 Hot Springs® General Purpose Cleaner	2/cs.
57083956	<i>4298150</i>	#33 Morning Mist® Superior-Cleaning Full-Fragrance Neutral Disinfectant Cleaner, 1:64	2/cs.



B. J-FILL® CHEMICAL CONCENTRATES DIVERSEY

The J-Fill® chemical management offers chemicals in special plastic 84.5 oz./2.5L containers. Built to be easy-to-use, chemicals can be dispensed at the touch of a button. Exclusive Spill-Tite cartridge helps prevent spills and accidental concentrate exposure. Dispensers are available in both hand held and wall mounted variations. 2.5 L.

15201512	<i>3401512</i>	Alpha-HP™ Multi-Surface Cleaner, 1:64-1:256	2/cs.
15202650	<i>3172650</i>	Crew® Bathroom Cleaner & Scale Remover, 1:18	2/cs.
15201650	<i>4271650</i>	Crew® Bowl Cleaner	2/cs.
15202641	<i>3172641</i>	Glance® NA Glass & Multi-Surface Cleaner Non-Ammoniated	2/cs.
15205779	<i>5779</i>	Glance® NA Glass & Multi-Surface Cleaner Non-Ammoniated, 1:40	2/cs.
15204965	<i>4965</i>	GP Forward™ General Purpose Cleaner, 1:200	2/cs.
15203846	<i>4994</i>	Spitfire™ NB Spray & Wipe Cleaner, 1:12	2/cs.
15204716	<i>4716</i>	Stride™ Citrus All Purpose Cleaner, 1:375-1:750	2/cs.
15204406	<i>4338</i>	Triad™ II Germicidal Cleaner And Deodorant, 1:64-1:128	2/cs.
15204329	<i>4329</i>	Virex™ II 256 Quaternary Disinfectant Cleaner, 1:256	2/cs.

C. RTD® CHEMICAL CONCENTRATES DIVERSEY

Requires virtually no training. Use right out of the box, no product or metering devices to connect. Easy to understand control knob uses simple icons to indicate different positions. Operating instructions enclosed in each case. Super-concentrated products deliver more gallons of RTU products than conventional packaging. Pre-installed metering ensures accuracy and eliminates over-use. Different fill rates, high flow for efficiency, low flow for low foam. Compact design makes transporting convenient and can be wall mounted with optional kits. No contact with concentrate increases worker safety. Specially designed handle promotes proper use while decreasing chance of error while operating.



1.5 L			
15205310	<i>3145310</i>	Crew® Bathroom Cleaner & Scale Remover	2/cs.
15201057	<i>3481057</i>	Fantastik® All Purpose Cleaner	1/ea.
15209601	<i>3719601</i>	Janitor In A Drum®	1/ea.
15209598	<i>3719598</i>	Mr. Muscle® Floor Cleaner	1/ea.
15209563	<i>3719563</i>	Scrubbing Bubbles® Bathroom Cleaner	1/ea.
15200210	<i>3313117</i>	Suma® Break-Up™ High Foaming Degreaser	2/cs.
15201049	<i>3481049</i>	Windex® Glass Cleaner	1/ea.
5 L			
57080436	<i>3143453</i>	#33 Morning Mist™ Full-Fragrance Neutral Disinfectant Cleaner, 1:64	1/ea.

Chemical Systems/Insecticides



A. RTD® HOOK-UP KIT DIVERSEY

RTD® products require a one-time purchase of a water hook-up kit to operate the system. Each water hook-up kit is bagged complete with bar code for easy individual resale to the end-user.

15201746 3191746 Hook-Up Kit 12/cs.



B. SOLUTIONS CENTER™ CHEMICAL CONCENTRATE DIVERSEY

The efficient way to prepare and fill ready-to-use cleaning products for use in maintaining your facility. Simply push a button on the two (Duo) or four button (Quattro) system for filling bottle, buckets, automatic scrubbers or carpet extractors.

15203437 4729 64 oz., Crew® Restroom Non-Acid Disinfectant Cleaner, 1:256 2/cs.

C. SUMA® DIVERSEY

Easy-to-use, maintenance-free manual warewashing program delivers accurate dilution without the need for equipment or permanent water connection. Designed for use in three-compartment sinks.

15200397 4603095 2.5 L, Final Step Optifill Sanitizer 1/ea.
15200396 4977476 2.5 L, Supreme Optifill Pot & Pan Detergent 1/ea.



INSECTICIDES

D. COBRA™ INSECT CONTROL SYSTEM DIVERSEY

Fast, safe and effective 24-hour fly control for food handling areas. Attracts insects with 3–15 watt UVA bulbs. Translucent cover increases UV emission and greatly improves catch. Captures insects on removable adhesive trapping boards, keeping them out of sight and intact. Operates silently—no zap or sizzle. Low voltage allows strategic placements. Easy maintenance of replacement bulbs and adhesive boards. Meets all FDA and USDA requirements for use in and around food handling facilities when used as directed.

15203567 4193567 22³/₈" x 16¹/₈" x 7³/₈", 45W Insect Light Trap 1/ea.
15203583 4193583 15 ct., Replacement Universal Adhesive Boards 15/cs.
152035915 4193591 Replacement Tubes Only (Sleeved) 2/cs.
15203575 4193575 Replacement Tubes Only (Standard) 2/cs.



E. RAID® DIVERSEY

Ant & Roach Killer

Raid ant and roach killer contains quick-killing pyrethrum for rapid kill action. It keeps killing up to four weeks.

15204400 CB216135 17¹/₂ oz., Outdoor Fresh 12/cs.

Commercial Flying Insect Killer

Specially formulated for extra-quick knockdown and kill of moths, flies, mosquitoes. Clears an entire room in minutes—fast knockdown of flies, mosquitoes, small flying moths and gnats. Use in restrooms, non-food handling areas of kitchens and garbage collection areas. Formula designed specifically for commercial and industrial insect control.

15200160 94892 19 oz. 6/cs.

Concentrated Deep Reach™ Fogger

Kills a broad range of insects. Designed for serious insect problems. Keeps killing for up to two months. Penetrates into cracks, crevices and carpet fibers to seek out and kill bugs where they live, breed and hide to relieve heavy infestations. Non-staining; won't leave a wet, messy residue.

15204797 CB815901 1¹/₂ oz., 3 Pack 36/cs.

Flying Insect Killer

Kills flies, mosquitoes, gnats, Asian lady beetles, and other flying insects as they fly through the mist, so there is no need to spray them directly. Plus, it has a clean, pleasant scent with no lingering chemical odor.

15209490 CB016605 15 oz. 12/cs.

Wasp & Hornet Killer

Kills paper wasps, yellow jackets, mud daubers and bald-faced hornets in seconds on contact. Sprays up to 22 feet. Allows you to kill from a distance. Dielectric breakdown voltage of 32,500 volts.

15209489 CB013536 14 oz. 12/cs.



Insecticides/Insect Repellent



A. SKIDOO® INSTITUTIONAL FLYING INSECT KILLER DIVERSEY

Kills houseflies, flying moths and gnats. Approved for use in and around food handling establishments. Active ingredients: Pyrethrins and Piperonyl butoxide.

15203286 4203286 16 oz. 6/cs.

B. VECTOR® DISCREET FLY SYSTEMS DIVERSEY

A stylish insect light trap which uses high efficiency, compact tubing offering the same light output as traditional fluorescent lamps. Unobtrusive; its attractive design allows for placement in public areas where fly control needs to be less obvious. Meets all FDA and USDA requirements for use in and around food handling facilities when used as directed.

15200078 95363 Each, 110V/60 Hz 1/ea.

15205364 95364 Each, Replacement Bulb, 15W 1/ea.

15200079 95365 24 Sets, Replacement Boards 24/cs.

C. ANT & ROACH SPRAY ZEP

Water-based crack and crevice spray for crawling insects. Non-staining formula may be applied to baseboards, windowsills and behind sinks. Also kills ticks, crickets, silverfish, cover mites, centipedes, fire ants and spiders.

75070090 R06001 24 oz. 12/cs.

D. FLYING INSECT KILLER ZEP

Versatile insecticide for space spraying and surface applications. Also effective against flying and crawling insects. Safe for use in food handling areas. Suitable for indoor and outdoor use. Natural pyrethrin formulation. Pleasantly fragranced.

75070091 R06101 24 oz. 12/cs.

E. INSECTICIDE W/RESIDUAL ACTION ZEP

Ready-to-use spray with residual insect killing power. For use on indoor and outdoor perimeter applications. Eight week residual killing properties. Non-staining and low odor formulation.

75070089 R05901 1 qt. 12/cs.

F. WASP & HORNET SPRAY ZEP

Long-reaching knockdown spray (up to 22'). Immediately kills on contact. Non-conductive up to 47,300V. Controls bees, wasps, hornets and yellow jackets. Safe for use around power lines. High pressure spray to reach difficult areas.

75070087 R05701 20 oz. 12/cs.

INSECT REPELLENT

G. OFF!® DIVERSEY

Active® Insect Repellent

15% DEET formula. Sweat resistant OFF! Active® repellent protects against mosquitoes that may be carrying the West Nile virus, biting flies, gnats, ticks, no-see-ums and a variety of other biting insects.

15201810 CB018104 6 oz. Aerosol, Fresh Scent 12/cs.

Deep Woods

25% DEET formula. Provides up to eight hours protection from mosquitoes. Non-greasy and resists perspiration. Repellents provide long-lasting repellency against ticks, mosquitoes, black flies, sand flies, chiggers, fleas, gnats and no-see-ums.

15200146 CB018425 6 oz. Aerosol 12/cs.

Deep Woods Towelettes

Repels mosquitoes that may carry West Nile Virus. Individually wrapped towelettes provide long-lasting protection from mosquitoes, ticks, biting flies, gnats and chiggers. Towelettes won't dry out and are conveniently carried in a vehicle, briefcase, toolbox or supply kit. DEET level is 25%.

15204905 CB549967 12 ct. 144/cs.

Familycare Spray

7% DEET formula. Spray repels mosquitoes, chiggers, ticks and other biting insects for up to two hours. Specially-formulated with a lower level of active ingredient and aloe vera to feel and smell better on your skin.

15204912 CB018357 6 oz. Aerosol, Unscented 12/cs.

Insect Repellent/Rodent & Weed Control/Lubricants



A. INSECT REPELLENT W/DEET ZEP

Apply directly to clothing and skin to repel flies, gnats, chiggers, ticks, and mosquitoes. Highly concentrated, non-oily formula is ideal for outdoor activities. Will not stain clothing. Contains 25% DEET.

75070088 R05801 7 oz. 12/cs.



RODENT CONTROL

B. D-CON® RECKITT BENCKISER

Bait Rat & Mouse Killer Pellets

Large "rat sized" pieces. Single feed formula. Contains four ready-to-use bait trays. Kills warfarin-resistant rats.

58340054 00252 12 oz. 12/cs.

Covered Mouse Trap

Reusable trap with no rodent contact. Catches mice not fingers. Easy disposal.

58340027 00027 Covered Mouse Trap 36/cs.

Mouse-Prufe II

Single feed formula. Easy-to-use wedge. Kills warfarin-resistant mice.

58340051 00051 1½ oz. Box 24/cs.

58340948 00948 1½ oz. Box, 4 ct. Multipack 60/cs.

Rat & Mouse Bait Block

Easy-to-use blocks. Less messy than regular bait pellets. Moisture-resistant for use in damp environments and humid climates.

58346443 76443 Rat & Mouse Bait Block 96/cs.

Ready Mixed Rat & Mouse Killer

Single feed formula. Ready-to-use bait trays. Kills warfarin-resistant mice and rats.

58340053 00202 12 oz., 4 Pack Trays 12/cs.

Wood Mouse Trap

Quick action mechanism. Easy-to-use. Twin pack trap packages.

58340105 00105 Wood Mouse Trap 72/cs.



WEED CONTROL

C. CONCENTRATED WEED KILLER & SOIL STERILANTS ZEP

Fast-acting, non-selective liquid weed and brush killer. Eliminates all vegetation including Bermuda grass and poison ivy. Sterilizes soil for up to four months. Excellent for use on road beds and walkways.

75070085 R05624 1 gal. 4/cs.

75070086 R05635 5 gal. 1/ea.



D. NON-SELECTIVE WEED KILLERS ZEP

Non-residual, non-selective herbicide. Controls weeds and brush in applied area. Effectively clears areas of all vegetation.

75070083 R05524 1 gal., Concentrate 4/cs.

75070084 R05535 5 gal., Concentrate 1/ea.



LUBRICANTS

E. PRIME SOURCE® MINERAL OIL LUBRICANT PRIME SOURCE®

White, food-grade mineral oil is odorless. Easily lubricates trolleys, meat hooks and other equipment in meat and food service industries.

75004008 75004008 32 oz. 12/cs.



F. PRIME SOURCE® PENETRATING OIL AEROSOL PRIME SOURCE®

Penetrating oil provides a protective film to reduce and resist corrosion. Non-flammable oil can loosen nuts and bolts quickly.

75004089 75004089 18 oz. 12/cs.



G. PRIME SOURCE® SILICONE RELEASE AEROSOL PRIME SOURCE®

Silicone release agent and lubricant prevents sticking, squeaking and binding on food processing equipment. Silicone is safe for use around food. Colorless, non-flammable, non-staining and water-resistant.

75004080 75004080 20 oz. 12/cs.



Lubricants/Automotive Treatments



A. PRIME SOURCE® WHITE LITHIUM GREASE AEROSOL

PRIME SOURCE®

Will not freeze, melt or wash away. Resists corrosion and provides superior lubrication on all metal applications.

75004090 75004090 10 1/4 oz. 12/cs.

B. WD-40® Lubricant

WD-40

Protects metal from rust and corrosion, penetrates stuck parts, displaces moisture, and lubricates just about anything. WD-40 is also great when it comes to cleaning grease, grime, and other marks from most surfaces. Cleans by getting under dirt, grime and grease. Also dissolves adhesives, allowing easy removal of labels, tape, stickers, and excess bonding material. Because WD-40 displaces moisture, it quickly dries out electrical systems to eliminate moisture-induced short circuits. Loosens rust-to-metal bonds and frees stuck, frozen or rusted metal parts. Lubricating ingredients are widely dispersed and hold firmly to all moving parts. Protects metal surfaces with corrosion-resistant ingredients to shield against moisture and other corrosive elements.

51840032 10032 12 oz., w/Smart Straw 12/cs.

No-Mess Pen

Precise application through a handy pen-shaped applicator.

51840076 10076 No-mess Pen 24/cs.



C. Z-WORKS

ZEP

Aerosol PTFE Lubricant

Premium, long-lasting lubricant. PTFE formulation penetrates rapidly to loosen parts frozen due to wear, corrosion, and grime buildup leaving behind a friction reducing film.

75070102 R07001 20 oz. 12/cs.

High Pressure Lubricant

Designed for high-load applications, product adheres to surfaces to prevent lubricant squeeze out or spin off. Sprays on surfaces as a liquid to penetrate into tight areas and sets up as a gel. Effective in a wide range of temperatures and environments.

75070103 R07101 20 oz. 12/cs.

PTFE Lubricant

Premium, long-lasting bulk lubricant. PTFE formulation penetrates rapidly to loosen parts frozen due to wear, corrosion, and grime buildup. Leaves behind a friction reducing film.

75070106 R07424 1 gal. 4/cs.

Rapid Penetrant

Multi-purpose, fast-acting aerosol penetrant and lubricant that effectively displaces water. Applies to surface as yellow foam to ensure even application and adequate contact time. Silicone formulation prevents corrosion.

75070104 R07201 24 oz. 12/cs.

Soy Penetrating Lubricant

Uses a renewable soy solvent to provide lasting lubrication while protecting against rust and corrosion. Excellent water displacing properties.

75070105 R07301 24 oz. 12/cs.



AUTOMOTIVE TREATMENTS

D. AEROSOL TIRE DRESSING

ZEP

High-gloss, water-resistant, silicone formulation tire dressing. For a uniform, long-lasting shine. Easy-to-use product gives tires a showroom look in seconds. Fast drying. Protects as it shines. VOC compliant.

75070124 R08401 24 oz. 12/cs.

E. FOAMING VEHICLE SHAMPOOS

ZEP

Environmentally preferred, ultra-concentrated liquid detergent formulated for friction car and truck washing facilities. Excellent for removing road film, dirt and salt deposits. Won't harm wax finishes.

75070118 R08124 1 gal. 4/cs.

75070119 R08135 5 gal. 1/ea.



Automotive & HVAC Treatments



A. TOUCHLESS FOAMING CAR & TRUCK DETERGENT ZEP

Foaming liquid formulation performs well in touchless vehicle washes, shampoo units, wheel and tire cleaning, and prep areas. May also be used in hybrid wash facilities or applied as a low pressure foam or spray.

75070120	R08235	5 gal.	1/ea.
75070121	R08250	20 gal.	1/ea.



B. TRUCK & TRAILER WASH ZEP

Premium liquid truck and trailer wash. Removes exhaust deposits, road film, and bug residues from painted vehicle surfaces. Cleans in one application.

75070116	R08024	1 gal.	4/cs.
75070117	R08035	5 gal.	1/ea.



C. VINYL & RUBBER PROTECTANTS ZEP

Ready-to-use, vinyl and rubber surface dressing. Protects from ozone, UV rays, and oxidation damage. Designed for use on vinyl, rubber, wood, acrylic, and plastic surfaces.

75070122	R08301	1 qt.	12/cs.
75070123	R08324	1 gal.	4/cs.



HVAC TREATMENTS

D. PRIME SOURCE® SOLVENT COIL CLEANER AEROSOL PRIME SOURCE®

Removes dirt, lint and grease from air conditioning condensers and refrigeration coils and fins. Contains no solvents, acids or alkalis. Coil cleaning improves efficiency and prevents overheating and burnout.

75004078	75004078	19 oz.	12/cs.
----------	----------	--------	--------



E. PRIME SOURCE® WATER-BASED COIL CLEANER AEROSOL PRIME SOURCE®

Water-rinseable foam removes dirt, lint and grease from air conditioning condensers and refrigeration coils and fins. Non-acid, non-alkaline formula dries without residue. Coil cleaning improves efficiency and prevents overheating and burnout.

75004079	75004079	19 oz.	12/cs.
----------	----------	--------	--------



F. AC COIL CLEANER ZEP

Concentrated, heavy-duty AC coil cleaner suitable for indoor use. Reduces cooling expense by promoting efficient heat transfer on coils.

75070095	R06524	1 gal.	4/cs.
75070096	R06535	5 gal.	1/ea.



G. AC PAN TABLETS ZEP

Potent, broad spectrum bacteriostat controls slime, harmful bacteria and eliminates blockages in drains and pans. Releases a biocide to continuously maintain AC drain pans. Protects walls and ceilings from condensate overflow. Use in apartments, refrigerated display cases, vending machines and industrial air systems. Effective against legionella.

75070094	R06402	24 ct.	24/cs.
----------	--------	--------	--------



H. FOAMING AC COIL CLEANER ZEP

Air conditioning coil cleaner designed to clean the exterior surfaces of coils on window and rooftop air conditioning units. Reduces cooling expense by promoting efficient heat transfer on coils. Does not require rinsing.

75070093	R06301	20 oz.	12/cs.
----------	--------	--------	--------



Bar & Powdered Soaps

BAR SOAPS

A. CASHMERE BOUQUET® BAR SOAP COLGATE-PALMOLIVE

Economical bar soap combines rich lather with a pleasing scent.

11901380	04120	1/2 oz., Wrapped	1000/cs.
11901400	04122	3/4 oz., Wrapped	1000/cs.
11901280	04148	1½ oz., Wrapped	500/cs.



B. DIAL® DEODORANT BAR SOAP DIAL

Dial bar soap provides superior antibacterial effectiveness and deodorant protection.

12800280	00910	3½ oz., Gold, Retail Wrap	72/cs.
----------	-------	---------------------------	--------



C. WHITE MARBLE DIAL® BAR SOAP DIAL

A mild, gentle cleansing soap made of naturally derived ingredients. Hypoallergenic formula is dermatologist tested and does not contain any harsh chemicals, heavy perfumes or other additives which can irritate the skin. Antibacterial.

12800194	00194	1½ oz., Wrapped	500/cs.
----------	-------	-----------------	---------



D. DOVE® BAR SOAP DIVERSEY

#1 cleansing bar recommended by dermatologists. Ideal for infant and long-term care. Non-irritating, non-soap moisturizing formula contains one quarter moisturizing cream.

15200044	CB614243	3½ oz., White	48/cs.
15200015	CB610795	4¼ oz., 8 Pack, White	72/cs.



E. LEVER 2000® BAR SOAP DIVERSEY

Clinically proven to be milder than other leading deodorant soaps. With a fresh clean scent, Lever 2000® refreshes and replenishes skin with nutrients and minerals without drying.

15203271	CB327126	3.15 oz., Perfectly Fresh™ Original	48/cs.
----------	----------	-------------------------------------	--------



F. LUX® BAR SOAP DIVERSEY

Economical, pure beauty soap leaves skin feeling clean and fresh. Superior lather, mild fragrance.

15200128	2979831	3.2 oz., Wrapped	73/cs.
----------	---------	------------------	--------



G. IVORY® BAR SOAP PROCTER & GAMBLE

Classic 99 44/100% pure floating soap bar contains no heavy perfumes, creams or dyes.

16902137	12364	3.1 oz., 3-Pack	72/cs.
----------	-------	-----------------	--------



H. SAFEGUARD® BAR SOAP PROCTER & GAMBLE

Combines unbeaten rich, creamy lather and unsurpassed deodorant soap protection. Contains antibacterial agents.

16908833	08833	4.3 oz., 4-Pack	48/cs.
----------	-------	-----------------	--------



I. LAVA® BAR SOAP WD-40

Lava is the original heavy-duty hand cleaner. Lava soap is specially formulated with pumice power to get even the dirtiest hands clean, and with the help of added moisturizers, keeps hands from feeling rough.

51840383	10383	4 oz.	48/cs.
----------	-------	-------	--------



POWDERED SOAPS

J. BORAXO® HEAVY-DUTY HAND SOAP DIAL

Contains larger granules for quicker cleaning and extra scrubbing action. Combines the scrubbing power of borax with the cleaning power of soap to easily dissolve grease and dirt when washing with water. 100% soluble and safe in septic systems.

12802858	02303	5 lb.	10/cs.
----------	-------	-------	--------

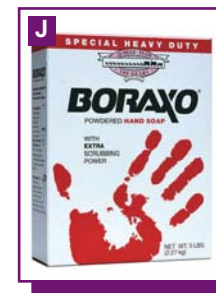

K. BORAXO® POWDERED HAND SOAP DIAL

Dual action Boraxo hand soap combines the scrubbing power of borax with the cleaning power of soap to easily dissolve grease and dirt when washing with water. 100% soluble and safe in septic systems.

12800030	02203	5 lb.	10/cs.
----------	-------	-------	--------



Powdered & Liquid Soaps



SOAPS



A. LURON PINK SOAP W/SKIN CONDITIONER DIAL

A combination of fine powdered soap and skin conditioner make this soap extra gentle on hands. Ideal for light manufacturing plants and offices. Soft rose scent and pink color. 100% soluble.

12802116 02403 5 lb. 10/cs.



B. ECONO COCONUT HAND SOAP PRIME SOURCE®

Economical all natural formulation.

75004221 75004221 1 gal. 4/cs.



C. SILKY HAND SOAP PRIME SOURCE®

All natural formulation. Luxurious rich lather. Mild on skin.

75004224 75004224 1 gal. 4/cs.

76008533 76008533 3.78 L 4/cs.

75004225 75004225 55 gal. 1/ea.



D. SMOOTH COCONUT HAND SOAP PRIME SOURCE®

All natural formulation produces luxurious rich lather and is pH balanced. Almond fragrance.

75004226 75004226 1 gal. 4/cs.

75004227 75004227 55 gal. 1/ea.

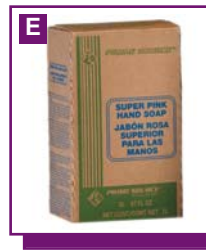

E. SUPER PINK HAND SOAP PRIME SOURCE®

Formulated to clean and help keep your skin soft and healthy.

75004203 75004203 1000 mL 8/cs.

75004204 75004204 2000 mL 4/cs.



F. CARE-ALL HAND CLEANSER CARROLL

Creamy soap leaves skin smooth and soft. PH balanced synthetic blend, doesn't leave soap scum. Thick liquid may be diluted 1:1 where less viscosity desired. Opaque pink color.

30016428 56428 1 gal. 4/cs.



G. TODAY'S CHOICE ALL PURPOSE HAND SOAP CARROLL

Designed for economically efficient skin cleansing and conditioning in general use, hand or body washing. This thick, pink, pearlescent product is pH balanced for extra mildness.

Provides copious lather and a fresh, pleasant fragrance. Does not leave a soap film. Ideal in washrooms and shower rooms in institutional, industrial and commercial facilities.

30010024 50617 800 mL 12/cs.



H. DOVE® HAND SOAP DIVERSEY

Extra mild hand cleaner designed for frequent hand washing environments. Ultra mild ingredients gently remove soil and bacteria without drying, chapping or irritating skin. Minimizes the damage caused by repeated removal of essential oils from the skin. Easy training with trilingual labeling.

15200116 2979401 1 gal. 4/cs.



I. KIMCARE® GENERAL ULTRA-KIND® GENTLE HAND WASH KIMBERLY-CLARK

A gentle cleanser with a pH-balanced formula that leaves hands soft and smooth. Dye-free formula with aloe vera.

15402519 92519 500 mL 18/cs.

Medicated Soaps

MEDICATED SOAPS

A. ANTIMICROBIAL HAND SOAP PRIME SOURCE®

High quality, low-cost lotion soap with antibacterial agent. Kills germs while providing gentle cleansing. Floral balsam fragrance.

75004215 75004215 1 gal. 4/cs.

B. E2 SANITIZING HAND SOAP PRIME SOURCE®

Formulated to clean, kill germs and help keep your skin soft and healthy.

75004232 75004232 2000 mL, Amber, Food Formula 4/cs.

C. GOLDEN ANTIMICROBIAL HAND SOAP PRIME SOURCE®

Formulated to clean and kill germs while helping keep your skin soft and healthy.

75004202 75004202 800 mL 12/cs.

75004205 75004205 1000 mL 8/cs.

75004206 75004206 2000 mL 4/cs.

76008578 76008578 1 gal. 4/cs.

D. SEPTISURGE ANTISEPTIC HAND CLEANER PRIME SOURCE®

Contains Triclosan for broad spectrum germ control on skin. Made with pure coconut oil.

75004214 75004214 1 gal. 4/cs.

E. PALPON® ANTIBACTERIAL LOTION SOAP CARROLL

Economical antimicrobial soap reduces germs and bacteria. Coconut oil based lotionized soap designed for frequent use. Creates excellent lather without drying skin. Pink opaque color and pleasant almond fragrance. USDA E1.

30010238 55728 1 gal., Pink 4/cs.

F. SOFTSOAP® ANTIBACTERIAL SOAP COLGATE-PALMOLIVE

Aquarium Series® Softsoap brand antibacterial hand soap. Kills a broad spectrum of germs with a proven germ fighting ingredient. Contains light moisturizers to leave your hands more than just clean. USDA E4.

11906800 26800 7½ oz. 12/cs.

G. SOFTSOAP® ANTIBACTERIAL SOAP W/MOISTURIZERS COLGATE-PALMOLIVE

Clinically proven to eliminate 99% of germs. Offers strong antibacterial protection. Gently cleans without leaving hands feeling dry. Light moisturizers help keep skin feeling smooth and soft. Dermatologist-tested.

11900003 26017 7½ oz. 12/cs.

11901929 01929 800 mL 12/cs.

11900002 01901 1 gal. 4/cs.

H. SOFTSOAP® ANTISEPTIC HAND WASH COLGATE-PALMOLIVE

Contains chloroxylenol to help eliminate dirt and germs on hands. Mild formula with a clean medicinal fragrance.

11901930 01926 800 mL 12/cs.

I. DIAL® GOLD LIQUID ANTIMICROBIAL SOAP DIAL

Broad spectrum antimicrobial effectiveness with added skin conditioners for mildness.

12800011 84014 7½ oz. Decor Pump 12/cs.

12800790 80790 16 oz. Pump 12/cs.

12807501 97501 800 mL Flex Pak 12/cs.

12804009 84019 1 L 8/cs.

12802738 88047 1 gal. 4/cs.

J. LIQUID DIAL® MOISTURIZING ANTIMICROBIAL SOAP DIAL

Broad spectrum antimicrobial effectiveness with extra moisturizers and conditioners including vitamin E to protect against dry skin. Ideal for frequent hand washing.

12804028 84029 1 L, Refill Jug 8/cs.



Medicated Soaps



A. LIQUID DIAL® SENSITIVE SKIN ANTIMICROBIAL SOAP **DIAL**
 Broad spectrum antimicrobial effectiveness. Extra mild, and formulated for very frequent hand washing. Hypoallergenic and dermatologist tested for even the most sensitive skin.

12800784	80784	16 oz. Pump	12/cs.
12802839	82839	1 L	8/cs.
12802838	82838	1 gal.	4/cs.



B. LUROSEP® ANTIMICROBIAL LOTION SOAP **DIAL**
 Added skin moisturizers make Lurosep mild and gentle even in frequent hand washing setting. pH balanced and non-irritating. Lurosep is more likely to be used regularly by health care personnel. Economical.

12802814	02814	1 gal.	4/cs.
-----------------	-------	--------	-------



C. SWEETHEART® ANTIBACTERIAL LOTION SOAP **DIAL**
 Economical high-quality hand soap contains Triclosan for effective antibacterial protection. Light, pleasing fragrance, unlike soaps with PCMX.

12806507	96507	800 mL	12/cs.
-----------------	-------	--------	--------



D. LEVER 2000® ANTIBACTERIAL LIQUID SOAP **DIVERSEY**
 Cleans and effectively reduces bacteria counts on the skin. Contains 0.25% Triclosan. Easy-to-use pump bottle. Easy training with trilingual labeling.

15200125	2979662	14 oz. Pump	12/cs.
15200011	2980196	1 gal.	4/cs.



E. GOJO® GOLD & KLEAN ANTIMICROBIAL LOTION SOAP **GOJO**
 Economical natural lotion formula contains chloroxylenol (PCMX), a broad-spectrum antimicrobial agent. Mild formula helps promote frequent handwashing while killing germs.

35402712	912712	800 mL	12/cs.
-----------------	--------	--------	--------



F. GOJO® RICH PINK ANTIBACTERIAL LOTION SOAP **GOJO**
 A high performance, gentle antibacterial lotion soap. For cleaning light soils.

35400017	722004	2000 mL	4/cs.
35407520	752002	5000 mL	2/cs.



G. GOJO® THICK PINK ANTISEPTIC SOAP **GOJO**
 Economical lotion soap provides germ-killing action. Contains 0.3% chloroxylenol (PCMX). For general restroom use. Pleasant fragrance.

35401848	184704	1 gal.	4/cs.
35401845	184504	1 gal. Flat Top	4/cs.



H. GOJO® ULTRA MILD ANTIMICROBIAL LOTION SOAP **GOJO**
 Lotion soap formula combines mild cleansers with 0.6% chloroxylenol (PCMX), a broad-spectrum antimicrobial agent. For gentle handwashing and effective germ killing.

35409212	921212	800 mL	12/cs.
35401208	211208	1000 mL, Fits NXT®	8/cs.
35400079	221204	2000 mL, NXT Maximum Capacity™	4/cs.



I. MICRELL® ANTIBACTERIAL LOTION SOAP **GOJO**
 Kills germs, yet is gentle on hands even after repeated daily washings. Contains quick-acting antimicrobial agent chloroxylenol (PCMX) and an effective degreaser. Lightly scented, non-irritating formula for frequent use.

35409752	975212	8 oz., Pump Bottle	12/cs.
35400039	975912	12 oz., Pump Bottle	12/cs.
35409755	975504	1 gal.	4/cs.
35401718	951718	500 mL, Fits Gemini®	18/cs.
35409756	975606	800 mL, Fits 800 Series	6/cs.
35409758	975712	800 mL, Fits 800 Series	12/cs.
35405704	215704	1000 mL, Fits NXT®	4/cs.
35405708	215708	1000 mL, Fits NXT®	8/cs.
35408810	718810	1000 mL, Fits 1000 Series	10/cs.
35400059	225704	2000 mL, NXT Maximum Capacity™	4/cs.

Medicated Soaps



A. PROVON® ANTIMICROBIAL LOTION SOAP GOJO

Antimicrobial handwash designed for general purpose use. Kills most common germs that may cause disease. Contains the broad-spectrum antimicrobial agent 0.3% chloroxylenol (PCMX). Citrus fragrance.

35405518	455518	500 mL, Fits Gemini™	18/cs.
35404212	421210	1000 mL, Fits 1000 Series	10/cs.
35401808	211808	1000 mL, Fits NXT®	8/cs.
35401804	221804	2000 mL, NXT Maximum Capacity™	4/cs.



B. PROVON® MEDICATED LOTION SOAP GOJO

Medicated hand cleanser with 0.3% chloroxylenol (PCMX) combines effective broad-spectrum antimicrobial activity with skin conditioners and emollients. Helps reduce the germs that may cause infections. Light citrus fragrance.

35404203	420124	4 oz., Squeeze Bottle	24/cs.
-----------------	--------	-----------------------	--------



C. KIMCARE® ALL-N-1 ANTIBACTERIAL SKIN CLEANSER KIMBERLY-CLARK

A mild, general-purpose antibacterial cleanser that is designed for everyday use. Its active ingredient, .25% Triclosan, helps protect against the spread of potentially harmful bacteria. ALL-N-1 is a replaceable soap system that provides a new, clean dispenser with each refill.

15405154	95154	1.5 L, White	4/cs.
-----------------	-------	--------------	-------



D. KIMCARE® ANTIBACTERIAL CLEAR SKIN CLEANSER KIMBERLY-CLARK

A mild, general-purpose antibacterial cleanser designed for everyday use. Its active ingredient, 0.25% Triclosan, helps protect against the spread of potentially harmful bacteria.

15401547	91547	800 mL, Light Floral	12/cs.
-----------------	-------	----------------------	--------



E. KIMCARE® ANTIBACTERIAL SKIN CLEANSER KIMBERLY-CLARK

A mild, general-purpose antibacterial cleanser designed for everyday use. Its active ingredient, 0.5% PCMX, helps protect against the spread of potentially harmful bacteria.

15401298	91298	800 mL, Light Floral	12/cs.
-----------------	-------	----------------------	--------



F. SAFEGUARD® LIQUID ANTIBACTERIAL SOAP PROCTER & GAMBLE

Contains the proven antibacterial ingredient Triclosan to help minimize the threat of a broad spectrum of bacteria. Contains a moisturizing ingredient to help fight dry skin.

16900034	07010	1 gal.	2/cs.
-----------------	-------	--------	-------



G. LYSOL® I.C.™ ANTIMICROBIAL SOAP RECKITT BENCKISER

Broad spectrum antimicrobial effectiveness to help reduce the spread of germs. Pleasant fragrance, mild and non-drying to skin. Lathers in both hard and soft water for maximum cleaning under all conditions. NSF Category Code E4.

58345717	95717	17½ oz., Pump Bottle	12/cs.
58345701	95701	1 gal.	4/cs.



H. TORK® ADVANCED ANTIBACTERIAL LIQUID SOAP 0.3% TRICLOSAN SCA TISSUE

This pH-balanced mild soap is perfect for sensitive skin and frequent washing. Portion control dispenses 1 mL every time, which allows for 1,000 hand washes. Unique pump with innovative technology prevents the dispenser from dripping and clogging.

14100711	400711	1 L, Chamomile	6/cs.
-----------------	--------	----------------	-------



I. MILD ANTIMICROBIAL HAND CLEANER ZEP

Mild hand cleaner, uses Triclosan to effectively remove soils and bacteria without harming hands. Fresh, clean fragrance. Contains emollients to leave hands feeling soft and smooth.

75070078	R05206	500 mL	12/cs.
75070079	R05224	1 gal.	4/cs.



Lotion Soaps



SOAPS



LOTION SOAPS

A. CARACO PINK LOTION HAND SOAP PRIME SOURCE®

Blended with the finest whole pure imported coconut oil; almond fragrance. Glycerin emollients retained for extra mildness to skin.

75004219 75004219 1 gal. 4/cs.

B. LOTION HAND SOAP PRIME SOURCE®

Formulated to clean and help keep your skin soft and healthy.

75004201 75004201 800 mL 12/cs.

C. READY-FOR-USE HAND SOAP CARROLL

This softly fragranced coconut oil hand soap is designed for economical and easy refill of liquid soap dispensers. Made with the finest edible-grade coconut oil and retaining its natural glycerin, it gently cleanses without drying out skin.

30010234 55328 1 gal. 4/cs.

D. SOFTSOAP® LIQUID SOAP W/ALOE COLGATE-PALMOLIVE

The #1 brand in liquid hand soaps. Gentle cleansing formula with a touch of aloe vera. Less drying than ordinary soap. Proven to eliminate tough dirt on hands. Dermatologist-tested.

11901120 26012 7½ oz. 12/cs.

11901820 01924 800 mL 12/cs.

11901900 01900 1 gal. 4/cs.

E. LURON LOTION SOAP DIAL

pH balanced and non-irritating. Soothing skin moisturizers. Mild and gentle even in frequent hand washing settings. More likely to be used regularly by health care personnel. Low cost.

12804050 84050 1 L 8/cs.

F. PURE & NATURAL® LIQUID LOTION SOAP DIAL

A hypoallergenic mild liquid lotion soap that is gentle on the skin. A fresh floral fragrance and rich lotion look and feel make this soap perfect for any commercial setting.

12800629 00629 1 L 8/cs.

12808628 08628 1 gal. 4/cs.

G. SWEETHEART® PINK LOTION SOAP DIAL

This pearlescent lotion soap is an excellent cost-effective choice for use in almost any facility.

12809506 99506 800 mL (Flex Pack) 12/cs.

H. H2 ENRICHED LOTION SOAP DIVERSEY

Rich lathering premium soap. Developed for those who frequently wash their hands. Proven to be mild on the skin even after repeated use.

15206410 3358964 1 L, Premium Lotionized Cleanser 12/cs.

I. GOJO® DELUXE LOTION SOAP W/MOISTURIZERS GOJO

Luxurious lotion soap with vitamins A and E to clean hands gently, even with frequent use.

For public facilities, offices, and general restroom use. Fresh, light floral fragrance.

35401708 211708 1000 mL, Fits NXT® 8/cs.

35400080 221704 2000 mL, NXT Maximum Capacity™ 4/cs.

J. GOJO® ENRICHED LOTION SOAP GOJO

Gentle, concentrated natural lotion soap with moisturizers. For general restroom use.

Pleasant, light fragrance.

35409102 910212 800 mL 12/cs.

K. GOJO® GREEN CERTIFIED LOTION HAND CLEANER GOJO

A mild, biodegradable lotion soap formula certified by Green Seal® and EcoLogo™ to meet their joint standard (GS41/CCD-104) for hand cleaners and hand soaps.

35406512 916512 800 mL, Green Seal® 12/cs.

35402165 216508 1000 mL, Fits NXT®, Green Seal® 8/cs.

Lotion Soaps



A. GOJO® LOTION SKIN CLEANSER GOJO

Mild cleansing lotion soap. For general restroom use. Pink, synthetic detergent formula.

35405318	955318	500 mL	18/cs.
35409113	911212	800 mL	12/cs.



B. GOJO® PINK & KLEAN SKIN CLEANSER GOJO

Rich, pearlized pink lotion soap formulated for extra value. Gentle cleansing with a clean rinse. Pleasant, light floral fragrance.

35400031	912812	800 mL	12/cs.
----------	--------	--------	--------



C. GOJO® WHITE COCONUT SKIN CLEANSER GOJO

A quality cleansing lotion that is mild to the skin. Ideal for general restroom use. Coconut fragrance.

35401812	181204	1 gal.	4/cs.
----------	--------	--------	-------



D. GOJO® WHITE PREMIUM LOTION SOAP GOJO

Rich, luxurious lather with a white, satin appearance. Dye-free formula with a fresh, spring rain fragrance.

35409104	910412	800 mL	12/cs.
----------	--------	--------	--------



E. KIMCARE® GENERAL GENTLE LOTION SKIN CLEANSER KIMBERLY-CLARK

Gentle lotion cleanser that removes light soils. Its neutral pH formula has a rich, creamy lather and pleasant floral fragrance.

15400054	92053	500 mL, Pink	18/cs.
15400055	91211	800 mL, Pink	12/cs.
15401018	91556	1000 mL, Pink	6/cs.



F. KIMCARE® GENERAL GENTLE LOTION SKIN CLEANSER W/DISPENSER KIMBERLY-CLARK

Gentle lotion cleanser that removes light soils. Its neutral pH formula has a rich, creamy lather and pleasant floral fragrance. ALL-N-1 is a replaceable soap system that provides a new, clean dispenser with each refill.

15405253	95253	2.5 L, Black	4/cs.
15400253	96253	2.5 L, White	4/cs.



G. KIMCARE® GENERAL GOLDEN LOTION SOAP KIMBERLY-CLARK

Suretouch® formula. A rich hand soap that removes light soils from the skin. High capacity and easy-to-load refill. Fits the Suretouch® Counter-Mounted Soap Dispensing System.

15401023	91437	1000 mL	3/cs.
----------	-------	---------	-------



H. KIMCARE® GENERAL PINK LOTION SOAP KIMBERLY-CLARK

Provides gentle cleaning. Easy-to-rinse lather and herbal fragrance.

15401923	91923	700 mL	4/cs.
15401220	91220	800 mL	12/cs.
15401300	91300	1 gal.	4/cs.
15400004	91302	1 gal., Flat Top	4/cs.



I. KIMCARE® GENERAL TRIANGLE® LOTION SOAP KIMBERLY-CLARK

An all purpose, synthetic hand lotion cleanser designed for removing light soils from the skin.

15400047	91241	800 mL, Floral	12/cs.
----------	-------	----------------	--------



J. CONTROLLED LOTION SOAP WAUSAU PAPER/BAY WEST

This white lotion soap is for general washroom use. Ideal for multipurpose needs in lavatories and designed to replace expensive bar soaps as well as low-quality liquid and powder soaps. Manufactured under strict cGMP regulations in a FDA registered facility for all OTC products. E-1 rated. Green Seal certified.

30030029	95100	500 mL	12/cs.
----------	-------	--------	--------



Foam Soaps

FOAM SOAPS



A. ANTIBACTERIAL FOAMING HAND SOAP PRIME SOURCE®

Gentle antimicrobial foam hand wash. Formulated to clean, kill germs and help maintain soft healthy skin.

76004253	76004253	1200 mL, Canada Label	2/cs.
75004229	75004229	1200 mL, US Label	2/cs.
75004228	75004228	1250 mL, Canada Label	3/cs.
75004237	75004237	1250 mL, US Label	3/cs.
75004256	75004256	1500 mL	2/cs.
75004240	75004240	2000 mL	2/cs.

B. E2 SANITIZING FOAMING HAND SOAP PRIME SOURCE®

Formulated to clean and help keep your skin soft and healthy.

75004246	75004246	1250 mL	3/cs.
75004247	75004247	2000 mL	2/cs.

C. FOAMING HAND SOAP PRIME SOURCE®

Rich gentle luxury foam hand wash. Formulated for an effective, pleasing hand wash experience. For general and light-duty cleaning. Fresh lavender fragrance.

75004253	75004253	1200 mL	2/cs.
----------	----------	---------	-------

D. FOAMING LOTION HAND SOAP PRIME SOURCE®

Formulated to clean and help keep your skin soft and healthy.

75004236	75004236	1250 mL	3/cs.
75004244	75004244	1500 mL	2/cs.
75004239	75004239	2000 mL	2/cs.



E. G2 FOAMING SOAP PRIME SOURCE®

A mild, biodegradable foam soap formula. Green Seal® and EcoLogo™ approved.

75004261	75004261	1200 mL, Green Seal®	2/cs.
75004260	75004260	1250 mL, Green Seal®	3/cs.
75004262	75004262	1500 mL, Green Seal®	2/cs.

F. DIAL COMPLETE® FOAMING HAND SOAP DIAL

Activated Triclosan Technology provides 25 times better germ-kill than other antimicrobial soaps. Effective against MRSA, VRE, Streptococcus, E. coli, and Salmonella. Hypoallergenic foam is excellent for frequent hand washing. NSF E-2 Rating.

12802935	02935	7½ oz. Pump, Cool Plum	8/cs.
12802934	02934	7½ oz. Pump, Fresh Pear	8/cs.
12802725	02725	7½ oz. Pump, Hospital Strength	12/cs.
12802936	02936	7½ oz. Pump, Regular	8/cs.
12801033	81033	1 L, Cool Plum	4/cs.
12802731	02731	50 oz., Regular	6/cs.

G. DIAL® COMPLETE ANTIMICROBIAL FOAMING HAND SOAP DIAL

Cost-effective, foaming dispensing system provides a high level of broad-spectrum germ-killing action to help stop the spread of infection. Patented Activated Tric Mild, hypoallergenic foaming soap formula contains aloe and glycerin to leave skin soft, smooth and refreshed. High-volume lather uses less soap. NSF Certified for an E2 rating. Light peach soap.

12800049	00163	800 mL Refill	6/cs.
12800162	00162	1 L Refill	6/cs.

H. GOJO® CX™ LUXURY FOAM ANTIBACTERIAL HANDWASH GOJO

Smooth, orange foaming handwash with germ-killing power in an orange blossom fragrance.

35405762	576204	535 mL, Pump Bottle	4/cs.
35406203	516203	1250 mL, Fits FMX-12™	3/cs.
35408562	856202	1500 mL, Fits CX™/CXi™	2/cs.
35406202	526202	2000 mL, Fits FMX-20™	2/cs.



Foam Soaps



A. GOJO® GREEN CERTIFIED FOAM HAND CLEANER GOJO

A mild, biodegradable foam soap formula certified by Green Seal® and EcoLogo™ to meet their joint standard (GS41/CCD-104) for hand cleaners and hand soaps.

35405715	571506	7½ oz., Tabletop Bottle, Green Seal®	6/cs.
35405725	572502	46 oz., Refill Bottle, Green Seal®	2/cs.
35405665	566502	1200 mL, Fits TFX™, Green Seal®	2/cs.
35405166	516503	1250 mL, Fits FMX-12™, Green Seal®	3/cs.
35408560	856502	1500 mL, Fits CX™/CXi™, Green Seal®	2/cs.
35405266	526502	2000 mL, Fits FMX-20™, Green Seal®	2/cs.



B. GOJO® HONEY ALMOND FOAM SOAP GOJO

Bulk foam soap with a honey almond scent.

35400175	500504	1 gal.	4/cs.
----------	--------	--------	-------



C. GOJO® LUXURY FOAM HANDWASH GOJO

Rich, gentle luxury foam handwash, pre-lathered for a convenient and pleasing experience. For general, light-duty cleaning. Translucent pink color and cranberry fragrance.

35406103	516103	1250 mL, Fits FMX-12™	3/cs.
35408561	856102	1500 mL, Fits CX™/CXi™/CXac™	2/cs.
35405261	526102	2000 mL, Fits FMX-20™	2/cs.



D. GOJO® PREMIUM FOAM ANTIBACTERIAL HANDWASH GOJO

Kills germs on hands while providing a rich, luxurious lather. Gentle on hands. Contains vitamin E and aloe. Fresh fruit fragrance.

35405710	571006	7½ oz., Pump Bottle	6/cs.
35405362	536202	1200 mL, Fits TFX™	2/cs.



E. GOJO® TFX™ PREMIUM FOAM HANDWASH W/SKIN CONDITIONERS GOJO

Provides rich, thick lather for a luxurious handwashing experience. Gentle on skin. Pleasant cranberry fragrance. Translucent purple color.

35405361	536102	1200 mL	2/cs.
----------	--------	---------	-------

F. PROVON® FOAMING ANTIMICROBIAL HANDWASH GOJO

Germ-killing foam handwash with moisturizers. Light floral fragrance. Contains 0.3% chloroxylenol (PCMX).

35405186	518603	1250 mL, Fits FMX-12™	3/cs.
----------	--------	-----------------------	-------



G. PROVON® FOAMING HANDWASH W/MOISTURIZERS GOJO

High-quality, luxurious foaming hand soap formulated with moisturizers and conditioners. General-purpose, mild formula. Cranberry fragrance.

35405189	518503	1250 mL, Fits FMX-12™	3/cs.
----------	--------	-----------------------	-------



H. KIMCARE® GENERAL LUXURY FOAM SKIN CLEANSER W/MOISTURIZERS KIMBERLY-CLARK

The Kimcare® Cassette Skin Care System features innovative refills and a wealth of advantages: 1L capacity so you refill less often than standard 800 mL refills. New flexibility with interchangeable foam or lotion skin care cassettes and dispensers compatible with universal mounting brackets also used in our All-N-1 product line. Fresh pump with each refill for greater hygiene and a better image. Easy loading. Easy recycling when pump is removed. Citrus Floral scent.

15401552	91552	1000 mL	6/cs.
----------	-------	---------	-------



I. KIMCARE® LUXURY FOAM ANTIBACTERIAL SKIN CLEANSER KIMBERLY-CLARK

The Kimcare® Cassette Skin Care System features innovative refills with interchangeable foam or lotion skin care cassettes. Fresh pump with each refill for greater hygiene and a better image. Easy loading and easy recycling when pump is removed. Fresh scent.

15401554	91554	1000 mL	6/cs.
----------	-------	---------	-------



Industrial Soaps



SOAPS



INDUSTRIAL SOAPS

A. BORAXO® HEAVY-DUTY HAND CLEANER DIAL

Two-in-one formula cleans and conditions. Special dry skin formula with a polymeric skin conditioning system to help keep skin from drying out. Light citrus scent.
12802327 02327 6 oz. 12/cs.

B. CREME HAND CLEANER GOJO

Creme formula for removing grease, tar and oil. Rub, then wipe clean with a towel or rinse off. No harsh solvents.
35404112 114112 14 oz. 12/cs.

C. GOJO® FINE ITALIAN PUMICE HAND CLEANER GOJO

Creme formula with Fine Italian Pumice scrubbing particles for extra cleaning action. For removing heavy grease, tar and oil.
35403506 113506 4 lb. 6/cs.

D. GOJO® LEMON PUMICE HAND CLEANER GOJO

Creme formula with fresh lemon fragrance and pumice scrubbers. For removing grease, tar, and oil. No harsh solvents.
35400013 091506 4½ lb. Cartridge 6/cs.

E. GOJO® MULTI GREEN® HAND CLEANER GOJO

A popular multi-purpose hand cleaner for removing light to medium industrial soils and dirt. Contains a natural, citrus solvent cleaner and non-abrading scrubbing particles.
35409172 917212 800 mL 12/cs.
35400018 726504 2000 mL 4/cs.
35400042 756502 5000 mL 2/cs.

F. GOJO® NATURAL ORANGE™ PUMICE HAND CLEANER GOJO

Quick-acting lotion formula with scrubbing particles for cleaning a broad range of industrial soils, medium dirt and grease. Orange citrus scent.
35400956 095706 14 oz., Grippit™ Bottle 6/cs.
35400957 095712 14 oz., Grippit™ Bottle 12/cs.
35400958 095806 1/2 gal., Pump Dispenser 6/cs.
35400954 095504 1 gal., Pump Dispenser 4/cs.
35407255 725504 2000 mL, PRO™ 2000 4/cs.
35405602 755602 5000 mL, PRO™ 5000 2/cs.

G. GOJO® NATURAL ORANGE™ SMOOTH HAND CLEANER GOJO

Quick-acting lotion formula for cleaning a broad range of industrial soils, medium dirt and grease. Orange citrus scent.
35400945 094504 1 gal., Pump 4/cs.

H. GOJO® ORANGE HAND CLEANER GOJO

Creme formula with citrus ingredients. For removing grease, tar and oil. Use with or without water. Rub and wipe clean with a towel or rinse off. No harsh solvents.
35400965 096506 4½ lb. Cartridge 6/cs.

I. GOJO® ORANGE PUMICE HAND CLEANER GOJO

Creme formula with orange citrus ingredients and natural pumice scrubbers. For removing grease, tar and oil. Use with or without water.
35400975 097506 4½ lb. Cartridge 6/cs.

J. GOJO® ORIGINAL FORMULA HAND CLEANER GOJO

Original Gojo® creme formula contains lanolin and soothing emollients for removing heavy grease, tar, and oil. Use with or without water. Wipe clean with a towel or rinse off.
35401318 110912 14 oz. 12/cs.
35400006 111506 4½ lb., For Creme-Style Dispenser 6/cs.

Industrial Soaps



A. GOJO® POWER GOLD® HAND CLEANER GOJO

A highly effective, fast-acting hand cleaner for removing the heaviest grease, tar, and oil. No harsh solvents. Contains natural, non-irritating scrubbing particles.

35400988	098802	2000 mL, Grippit™ Bottle w/Nail Brush	2/cs.
35400014	729504	2000 mL, PRO™ 2000	4/cs.
35407595	759602	5000 mL, PRO™ 5000	2/cs.



B. GOJO® PROFESSIONAL PAINT & STAIN HAND CLEANER GOJO

Uniquely formulated hand cleaner for quickly removing a variety of paints, stains and inks. Contains a highly effective, safe, plant-derived solvent and no petroleum distillates.

35401016	101612	5 oz., w/Counter Display	12/cs.
----------	--------	--------------------------	--------



C. GOJO® SUPRO MAX™ HEAVY-DUTY HAND CLEANER GOJO

Fast and effective lotion hand cleaner removes tough, sticky soils and adhesives while leaving skin conditioned and healthy feeling. Unique blend of cleaners, skin conditioners, and gentle scrubbers. Ideal for plant-wide use. Non-drying formula.

35407204	727204	2000 mL, PRO™ 2000	4/cs.
35407202	757202	5000 mL, PRO™ 5000	2/cs.



D. KIMCARE® INDUSTRIE SUPER-DUTY HAND CLEANSER W/GRIT KIMBERLY-CLARK

Formulated to clean the toughest dirt, including grease and tar. Contains aloe vera and no petroleum solvents.

15401757	91757	3.5 L	2/cs.
15400051	91748	8 L	2/cs.

E. SIMPLE GREEN® HAND CLEANER GEL SIMPLE GREEN

Hand cleaner gel has the powerful cleaning ability of Simple Green while being easy on the hands. Contains natural pumice to help remove stubborn dirt and grease and lanolin for moisturizing and protecting skin.

73432150	42150	5 oz.	12/cs.
73432128	42128	1 gal.	4/cs.

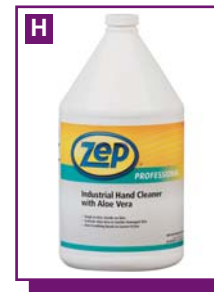

F. CHERRY INDUSTRIAL HAND CLEANER W/ABRASIVE ZEP

Heavy-duty cherry scented hand cleaner with pumice. Removes tough greases, oils, and odors. Contains emollients to moisturize hands and prevent dryness.

75070074	R04824	1 gal.	4/cs.
----------	--------	--------	-------

G. CHERRY INDUSTRIAL HAND CLEANER W/O ABRASIVE ZEP

Cherry scented hand cleaner without abrasive. Removes tough greases, oils, and odors. May be used with or without water. Contains emollients to moisturize hands and prevent dryness.

75070081	R05401	1 qt.	12/cs.
75070082	R05424	1 gal.	4/cs.

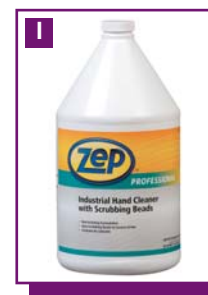

H. INDUSTRIAL HAND CLEANER W/ALOE VERA ZEP

Premium, mild solvent-based hand cleaner, easily removes grease with tiny scrubbing beads. Formulated with aloe to soothe hands while cleaning.

75070076	R05024	1 gal.	4/cs.
----------	--------	--------	-------

I. INDUSTRIAL HAND CLEANER W/SCRUBBING BEADS ZEP

Heavy-duty hand cleaner with no solvents, will not dry out hands. Contains tiny scrubbing beads to aid in the easy removal of grease and grime without damaging skin.

75070075	R04924	1 gal.	4/cs.
----------	--------	--------	-------

J. ORANGE INDUSTRIAL HAND CLEANER W/ABRASIVE ZEP

Heavy-duty, citrus scented hand cleaner with pumice. Uses citrus solvents to remove tough greases, oils, and odors.

75070077	R05124	1 gal.	4/cs.
----------	--------	--------	-------



K. SOY INDUSTRIAL HAND CLEANER ZEP

Environmentally preferred hand cleaner. Uses a powerful yet mild combination of soy solvents and walnut shell abrasive to loosen tough grime. Apple cinnamon fragrance.

75070080	R05324	1 gal.	4/cs.
----------	--------	--------	-------

Body/Hair Shampoo



HAIR/BODY SHAMPOO

A. FOAMING HAIR/BODY SHAMPOO PRIME SOURCE®

Formulated to clean and help keep your skin soft and healthy.

75004238	75004238	1250 mL	3/cs.
75004241	75004241	2000 mL	2/cs.

B. HAIR/BODY SHAMPOO PRIME SOURCE®

Formulated to clean and help keep your skin soft and healthy.

75004207	75004207	1000 mL	8/cs.
75004208	75004208	2000 mL	4/cs.

C. PEARL WHITE HAND & BODY SOAP PRIME SOURCE®

Produces a luxurious lather that is pH balanced and mild on skin. Cherry almond fragrance.

75004222	75004222	1 gal.	4/cs.
75004223	75004223	55 gal.	1/ea.

D. DIAL® BODY & HAIR SHAMPOO DIAL

The fresh, fragrant formula has been specially formulated for effective cleansing of the entire body. The pH balanced formula leaves hair looking silky, shiny and manageable, while added conditioners help keep skin feeling soft and smooth. Dial Body & Hair Shampoo has an appealing, gender-neutral peach fragrance and abundant lather that rinses with ease.

12803986	03986	1 gal.	4/cs.
----------	-------	--------	-------

E. GOJO® LATHER & KLEAN HAIR & BODY SHAMPOO GOJO

A gentle enriched lotion soap formulated for the body and hair.

35402612	912612	800 mL	12/cs.
----------	--------	--------	--------

F. GOJO® LUXURY FOAM HAIR & BODY WASH GOJO

Green, spa-quality foam body wash and hair shampoo with a cucumber melon scent.

35406303	516303	1250 mL, Fits FMX-12™	3/cs.
35405263	526302	2000 mL, Fits FMX-20™	2/cs.

G. GOJO® SHOWER SPA BODY & HAIR SOAP GOJO

Luxurious, creamy hair and body soap formulated with aloe and jojoba oil to help condition and protect skin and hair.

35407134	713410	1000 mL	10/cs.
----------	--------	---------	--------

H. GOJO® SHOWER UP® SOAP & SHAMPOO GOJO

Rich hand, hair, and body soap that provides a clean alternative to non-hygienic bar soaps. Ideal for use in health clubs and fitness centers. Synthetic, clean-rinsing formula will not build up on shower walls. Rose-colored with a pleasantly clean fragrance.

35400019	723004	2000 mL	4/cs.
35403002	753002	5000 mL	2/cs.

I. GOJO® SPA BATH® BODY & HAIR SHAMPOO GOJO

Luxurious, enriched formula for hands, hair and body soap. Ideal for use in health clubs and fitness centers. Synthetic, clean-rinsing formula will not build up on shower walls. Pleasant herbal fragrance.

35409152	915212	800 mL	12/cs.
35400078	225204	2000 mL NXT Refill	4/cs.
35400002	915504	1 gal. Flat Top	4/cs.

J. PROVON® ENRICHED SHAMPOO FOR BODY & HAIR GOJO

A clean-rinsing, head-to-toe shampoo and body wash. Combines skin and hair cleansing ingredients in a dermatologist-tested formulation. Highly concentrated, enriched with aloe and vitamin E. Light herbal fragrance.

35404016	401604	1 gal.	4/cs.
----------	--------	--------	-------

Hand Sanitizers

HAND SANITIZERS

A. HAND SANITIZER CLEAR GEL PRIME SOURCE®

Formulated to clean, kill germs and help keep your skin soft and healthy.
75004231 75004231 1000 mL 8/cs.



B. CLOROX® ANYWHERE™ HAND SANITIZING SPRAY CLOROX

Formulated to kill 99.999% of germs. The non-drying formula contains natural ingredients that keep hands moisturized and soft without leaving a sticky or greasy residue behind. The spray delivery provides excellent coverage and targeted application to areas such as fingernails and knuckles.
38382176 02176 500 mL 12/cs.



C. SOFTSOAP® INSTANT HAND GEL SANITIZER COLGATE-PALMOLIVE

Kills 99% of most common germs within 15 seconds without soap or water. Helps reduce the spread of hand-to-food borne bacteria. No soap, water or towels needed. Evaporates quickly, contains moisturizers and is fragrance-free.
11901922 01922 800 mL 12/cs.



D. DIAL® ANTIBACTERIAL HAND SANITIZER DIAL

Provides convenient, effective germ-kill that works to kill harmful disease-causing germs, yet is gentle on the hands. Kills 99.999% of pathogenic germs in as little as 15 seconds. Effective against bacteria, yeast and molds. Latex and non-latex compatible and NSF E-2 Certified. Dermatologist tested and hypoallergenic. Fragrance and dye-free. Contains added moisturizers and skin conditioners to soften and smooth the hands.
12800685 00685 4 oz. Flip-Top 24/cs.
12805862 95862 800 mL 12/cs.



E. PURELL® 2-IN-1 INSTANT HAND SANITIZER + MOISTURIZER GOJO

A rich lotion, alcohol-based sanitizer that kills 99.99% of germs in 15 seconds. Contains a unique combination of moisturizers to help improve skin condition and leave hands feeling soft. Absorbs quickly into the skin. Meets protocol for Healthcare Personnel Handwash. Latex and CHG compatible, dermatologist tested. Herbal fruit fragrance. Ethyl alcohol 62%.
35409649 964912 12 oz. Bottle 12/cs.



F. PURELL® DESK CADDY GOJO

Personalized place-holder for favorite photos. Easy access encourages frequent use to help minimize the spread of germs in the workplace.
35409602 9600DC1BLK 8 oz. 12/cs.



G. PURELL® FOOD CODE COMPLIANT HAND SANITIZER GOJO

Kills 99.99% of most common germs that may cause illness. Works in as little as 15 seconds and no water or towels are needed. Meets Food and Drug Administration Food Code Hand Sanitizer Requirements (Section 2-301.16) with ingredients that are safe for use by employees with direct food contact. Alcohol-based.
35406604 216604 1000 mL, Fits NXT® 4/cs.



H. PURELL® FST™ PURELL HAND SANITIZER GOJO

Stay healthy and mission-ready with the Purell® FST™ Military bottle. Special side grips for easy one-handed dispensing. Flexible, lightweight design fits in pockets or pouches. Built tough enough for military use. Low infrared signature for night (NVG) operations.
35402424 962424 3 oz., Military Bottle 24/cs.



I. PURELL® GREEN CERTIFIED HAND SANITIZER GOJO

Made from 100% naturally renewable ethanol. Meets the USDA BioPreferred program for biobased content. Readily compostable gel formula. Meets the EcoLogo™ hand sanitizer standard CCD-170 for environmental leadership and proven performance.
35400219 969112 8 oz. Bottle 12/cs.
35400221 369112 12 oz. Bottle 12/cs.
35400222 509103 1200 mL, Fits FMX™ 3/cs.
35400218 549104 1200 mL, Fits FMX™ 4/cs.



Hand Sanitizers



SOAPS



A. PURELL® GREEN CERTIFIED HAND SANITIZER FOAM GOJO

Made from 100% naturally renewable ethanol. Meets the USDA BioPreferred program for biobased content. Readily compostable non-aerosol foam formula. Meets the EcoLogo™ hand sanitizer standard CCD-170 for environmental leadership and proven performance.

35400223	579104	535 mL Bottle	4/cs.
35400224	519103	1200 mL, Fits FMX™	3/cs.
35400217	539102	1200 mL, Fits TFX™	2/cs.



B. PURELL® INSTANT HAND SANITIZER GOJO

Instant hand sanitizer kills 99.99% of most common germs that may cause illness. Works in as little as 15 seconds, with no water or towels needed. Specially formulated with moisturizers to leave hands feeling soft and refreshed. Alcohol-based.

35403796	379636	1/2 oz., Jelly Wrap	36/cs.
35403007	300560	1/2 oz., Pocket Bottle w/Display Bowl	60/cs.
35400624	960624	2 oz., Pump Bottle	24/cs.
35403034	303424	2 oz. + 1 oz., +1 oz. Free	24/cs.
35409652	965124	4 oz., Bottle	24/cs.
35405212	965212	8 oz., Pump Bottle	12/cs.
35409653	965412	250 mL Refill	12/cs.
35401212	301212CMR	8 oz., Ocean Mist, Pump Bottle	12/cs.
35401415	301412CMR	8 oz., Spring Bloom, Pump Bottle	12/cs.
35403053	305312	8 oz. + 4 oz., Pump	12/cs.
35400044	965912	12 oz., Pump Bottle	12/cs.
35403043	304312	12 oz., Pump (50% More Free)	12/cs.
35409659	9659D2	12 oz., Pump Bottle w/Holder	6/cs.
35403023	302312	20 oz., Pump Bottle	12/cs.
35409656	965606	800 mL, Fits 800 Series	6/cs.
35409657	965712	800 mL, Fits 800 Series	12/cs.
35405604	215604	1000 mL, Fits NXT®	4/cs.
35405608	215608	1000 mL, Fits NXT®	8/cs.
35402003	545604	1200 mL, Fits TFX™	4/cs.
35400063	225604	2000 mL, NXT Maximum Capacity™	4/cs.
35409625	962504	2 L, Pump Bottle	4/cs.



C. PURELL® INSTANT HAND SANITIZER FOAM GOJO

Non-aerosol, alcohol-based foam sanitizer with the exclusive Dermaglycerin System™. Clinically proven to improve healthcare worker skin hydration in 14 days. A synergistic moisturizing blend with broad-spectrum antimicrobial efficacy. Contains seven moisturizers for optimal skin conditioning. Fragrance-free, dye-free. Compatible with latex, nitrile and vinyl gloves and CHG. Meets CDC and APIC recommendations.

35409804	579804	535 mL, Pump Bottle	4/cs.
35400183	519803	1200 mL, Fits FMX-12™	3/cs.
35409203	519203	1200 mL, Fits FMX-12™, Advanced	3/cs.
35405398	539802	1200 mL, Fits TFX™	2/cs.
35409202	539202	1200 mL, Fits TFX™, Advanced	2/cs.



D. PURELL® INSTANT HAND SANITIZER W/ALOE GOJO

Kills 99.99% of most common germs that may cause illness. Works in as little as 15 seconds and no water or towels are needed. Contains aloe and is specially formulated with moisturizers that leave hands feeling soft and refreshed without stickiness or residue.

35403124	963124	4 1/4 oz., Squeeze Bottle	24/cs.
35409675	967412	8 oz., Pump Bottle	12/cs.
35409639	963912	12 oz., Pump Bottle	12/cs.
35403708	213708	1000 mL, Fits NXT®	8/cs.



E. PURELL® MOISTURE THERAPY INSTANT HAND SANITIZER GOJO

A rich lotion, alcohol-based sanitizer that kills 99.99% of germs in 15 seconds. Contains a unique combination of moisturizers to help improve skin condition and leave hands feeling soft. Absorbs quickly into the skin. Meets protocol for Healthcare Personnel Handwash. Latex and CHG compatible, dermatologist tested. Herbal fruit fragrance. Opaque white color. Ethyl alcohol 62%.

35409552	955212CMR	12 oz. Pump Bottle	12/cs.
----------	-----------	--------------------	--------

Hand Sanitizers/Hand & Body Wipes



A. PURELL® PAL PUMP BOTTLE W/HOLDER GOJO

An engaging "pal" that makes Purell® readily available for use. Easy access encourages frequent use to help minimize the spread of germs in the workplace.

35409600	9600PL1	8 oz.	12/cs.
35403118	9600PL1	8 oz.	18/cs.



B. PURELL® RETRACTABLE CLIP GOJO

Convenient clasp attaches easily to clothing. For use with 9660-24 pump bottle.

35400824	960824	Retractable Clip	24/cs.
----------	--------	------------------	--------



C. KIMCARE® INSTANT HAND SANITIZER KIMBERLY-CLARK

Kills germs without soap and water. Kills 99.9% of germs in as little as 15 seconds and offers the convenience of waterless application. No water or towels required, just rub it in and get on with your work. Safe for indirect food contact use. Light citrus scent. Dermatologist tested. Latex glove compatible.

15403066	93066	2 oz.	24/cs.
15409306	93060	8 oz.	12/cs.



D. KIMCARE® MOISTURIZING INSTANT HAND SANITIZER KIMBERLY-CLARK

An advanced hand sanitizer formulated to prevent dry skin while it kills germs. 62% ethyl alcohol formula with patented Microsponge technology provides fast, broad-spectrum antimicrobial action, in a pleasant, lightly-scented lotion.

15403056	93056	8 oz.	12/cs.
----------	-------	-------	--------



E. NATURALLY TUFF® ORANGE HAND CLEANER W/GRIT KIMBERLY-CLARK

Designed to remove tougher grime without water. Contains polymer beads for scrubbing without the abrasion associated with other grits. Has a fresh, citrus scent.

15401057	91057	1 gal.	4/cs.
----------	-------	--------	-------



HAND & BODY WIPES

F. GOJO® FAST WIPES® HEAVY-DUTY HAND CLEANING TOWELS GOJO

Hand cleaning towels for quick clean-up of light greases and oils. For use at the job site or wherever water is not available.

35406283	628206	25 Wipe Pack	6/cs.
35406285	628506	60 Wipe Pack	6/cs.
35406298	629804	130 Wipe Bucket	4/cs.



G. PURELL® HAND SANITIZING TOWELETTES GOJO

Enhance guest experience and satisfaction with economical towelettes that clean and sanitize. Individually wrapped, "on-the-go" amenity item for a wide variety of markets, including foodservice, travel and hospitality. Made with 62% ethyl alcohol, the same active ingredient as Purell® Instant Hand Sanitizer.

35409022	902210	100 ct., 5" x 7"	1000/cs.
----------	--------	------------------	----------



H. PURELL® HAND SANITIZING WIPES GOJO

All the germ-killing benefits of Purell®, America's #1 instant hand sanitizer, in a non-linting, durable wipe. Textured for superior cleaning. Water-resistant individual packaging. Ideal for "on-the-go" use when a larger, softer and more premium towel is preferred. Alcohol-based formula kills 99.99% of most common germs that may cause illness. Convenient and easy-to-use in offices, restaurants, health clubs or anywhere else germs may be.

35403602	360206	24 ct. Singles	6/cs.
35409011	901112	35 ct. Canister	12/cs.
35401006	901006	175 ct. Canister	6/cs.
35400207	911802	1200 ct. Refill Pouch	2/cs.



I. PURELL® WALL BRACKET FOR SANITIZING WIPES GOJO

Convenient, easy-to-install wall-mount bracket allows 175-count Purell® Sanitizing Wipes to be readily available. Perfect for high-traffic, high-volume applications. Wipes sold separately.

35409014	901401	Fits 175 ct. Canister	1/ea.
----------	--------	-----------------------	-------



Hand & Body Wipes/Lotion/Soap Dispensers



A. AT EASE® PERSONAL CLEANSING WASHCLOTH **HOSPECO**
 Pre-moistened wipes with aloe and lanolin formulation. Non-woven, not airlaid paper, provides soothing and gentle feeling of cloth. Extra large wiper completely covers the hand. One wipe does the job. Clingfree; unfolds with little effort. Superior strength. Pleasant fragrance. Alcohol free. Hypoallergenic. Latex-free. Flip-top reclosable softpack.
14503821 HS3899 50 ct., 9" x 13" 600/cs.



B. KLEENEX® SPLASH 'N GO!® HAND & FACE WIPES **KIMBERLY-CLARK**
 Pre-moistened hand and face wipes formulated with aloe and vitamin E.
15405935 75935 35 ct., Re-Sealable Pack 560/cs.
15405211 75211 42 ct., Tub 12/cs.



C. WYPALL® WATERLESS HAND WIPES **KIMBERLY-CLARK**
 Pre-moistened wipes with a heavy-duty waterless cleanser, ideal for hand cleaning anywhere.
15408310 58310 50 ct. Canister, 10 1/2" x 12" 400/cs.
15401371 91371 75 ct. Canister, 10 1/2" x 12 1/4" 450/cs.



D. PDI® SANI-CLOTH® HB GERMICIDAL DISPOSABLE WIPES **SANI PROFESSIONAL**
 Quat-based hospital grade disinfectant does not contain alcohol. Bactericidal, tuberculocidal, and virucidal. Appropriate for fitness centers, airplanes, nursing homes and restaurants. Strong, diamond-embossed wipe material.
49680584 Q10584 160 ct., 6" x 6 3/4" 960/cs.



E. SANI-HANDS® HAND SANITIZING WIPES **SANI PROFESSIONAL**
 These premoistened hand sanitizing wipes are formulated for use in food service areas of restaurant, supermarkets and institutional feeding. They contain an emollient to prevent skin from drying.
49683884 Q43884 220 ct., 6" x 7 1/2" 1320/cs.



F. WET-NAP® MOIST TOWELETTES **SANI PROFESSIONAL**
 Pre-moistened towelettes for convenient clean-up when soap and water are not available. Fresh lemon scent. Does not contain alcohol.
49681100 D11000 100 ct., 7 3/4" x 5", Boxed 1000/cs.



G. GOJO® HAND MEDIC® PROFESSIONAL SKIN CONDITIONER **GOJO**
 Specifically formulated for professional technicians for use in their work environments. Quickly absorbs, with no greasy after-feel. Use before work, after handwashing, and at night to help maintain the skin's natural protective barrier. Silicone and fragrance-free.
35408150 815012 5 oz. Tube 12/cs.



H. VASELINE® INTENSIVE CARE® TOTAL MOISTURE DRY SKIN LOTION **DIVERSEY**
 Hydrates and replenishes dry skin. Enriched with Vitamin E and minerals to give skin essential moisture where it needs it most. Non-greasy, fast absorbing formula leaves skin feeling silky smooth and comfortable.
07519001 CB079001 24 1/2 oz., Pump Dispenser Bottle 6/cs.



SOAP DISPENSERS



I. COUNTERMOUNT SOAP DISPENSER **PRIME SOURCE®**
 Countermount soap dispenser.
75004250 75004250 1000 mL 1/ea.

J. COUNTERMOUNT TOUCH-FREE SOAP DISPENSERS **PRIME SOURCE®**
 Touch-free soap countermount dispenser systems.
75004255 75004255 1000 mL 1/ea.
760042131 76004213 1000 mL, Gray 1/ea.

Soap Dispensers



A. FOAMING SOAP DISPENSERS PRIME SOURCE®

Wall mounted foaming soap dispensers.

750042591	75004259	1250 mL, Black, No Logo	1/ea.
750042451	75004245	1250 mL, Black	1/ea.
75004259	75004259	1250 mL, Black, No Logo	6/cs.
75004245	75004245	1250 mL, Black	6/cs.
750042421	75004242	1250 mL, Gray	1/ea.
75004242	75004242	1250 mL, Gray	6/cs.
75004249	75004249	2000 mL, Black	6/cs.
750042431	75004243	2000 mL, Gray	1/ea.
75004243	75004243	2000 mL, Gray	6/cs.



B. SOAP DISPENSERS PRIME SOURCE®

Wall mounted bag-in-the-box system soap dispensers.

750042331	75004233	800mL, Black	1/ea.
75004233	75004233	800mL, Black	12/cs.
750042101	75004210	800mL, White	1/ea.
75004210	75004210	800mL, White	12/cs.



C. SOAP DISPENSERS PRIME SOURCE®

Wall mounted soap dispenser systems.

75004234	75004234	1000 mL, Black	6/cs.
750042111	75004211	1000 mL, Gray	1/ea.
75004211	75004211	1000 mL, Gray	6/cs.



D. SOAP DISPENSERS PRIME SOURCE®

Wall mounted soap dispenser systems.

75004235	75004235	2000 mL, Black	8/cs.
750042121	75004212	2000 mL, Gray	1/ea.
75004212	75004212	2000 mL, Gray	8/cs.

E. SOAP DISPENSER PRIME SOURCE®

Twin wall mounted soap dispenser system.

75004230	75004230	1000 mL, Gray	6/cs.
----------	----------	---------------	-------

F. TOUCH-FREE SOAP DISPENSER PRIME SOURCE®

Wall mounted foaming soap dispenser system.

750042131	75004213	1200 mL, Gray	1/ea.
75004213	75004213	1200 mL, Gray	12/ea.



G. TOUCH-FREE SOAP DISPENSERS PRIME SOURCE®

Touch-free soap dispenser systems.

750042541	75004254	1000 mL, Black	1/ea.
75004254	75004254	1000 mL, Black	12/ea.
75004248	75004248	1000 mL, Gray	1/ea.

H. PUSH STYLE SOAP DISPENSER COLGATE-PALMOLIVE

Gentle push bar, designed to fit the curve of the human hand. Easily delivers the exact amount of soap needed. Compact cabinet design provides a sleek, unobtrusive look.

11901941	01946	800 mL, Gray	1/ea.
11901944	01946	800 mL, Gray	12/cs.

I. GOJO® 800 BAG-IN-BOX DISPENSERS GOJO

Traditional bag-in-box dispensers. ADA compliant, one hand push operation reinforces mounting with each use. Portion control helps reduce waste.

354090321	903312	800 mL, Black	1/ea.
354000271	903412	800 mL, Ceramic White	1/ea.
35400027	903412	800 mL, Ceramic White	12/cs.



Soap Dispensers



A. GOJO® CXI™ TOUCH-FREE COUNTER MOUNT SOAP DISPENSER **GOJO**
 Reliable, touch-free counter mount foam soap system. Sanitary Sealed™ cartridge system provides neat, clean performance. Cartridges are easy to load and provide 1500 dispenses per refill. Gojo® Neat Dispense™ design helps eliminate messy drips. Chrome finish complements other restroom fixtures.
35402101 852001 1500 mL 1/ea.



B. GOJO® CX™ COUNTER DISPENSER **GOJO**
 Gojo® CX™ Counter Mount System delivers rich, luxurious foam soap. Snap-in-place cartridge system makes refills quick, easy and sanitary.
35408500 850001 1500 mL 1/ea.



C. GOJO® FMX-12™ FOAM SOAP DISPENSERS **GOJO**
 Great for locations where a smaller, traditional-sized dispenser is preferred. Delivers more than 1700 hand washes. Features skylight with an extra-large site window. ADA compliant, one hand push operation. Optional key lock included.
35405007 515006 1250 mL, Dove Gray 6/cs.
35405005 5155PL 1250 mL, Black, No Logo 6/cs.
35405008 515506 1250 mL, Black 6/cs.



D. GOJO® FMX-20™ FOAM SOAP DISPENSER **GOJO**
 Holds a big 2000 mL refill in a remarkably small footprint. Enough soap for over 2800 handwashes.
35405006 525006 2000 mL, Dove Gray 6/cs.



E. GOJO® NXT® MAXIMUM CAPACITY™ SOAP DISPENSER **GOJO**
 Holds 2000 mL of product, twice the capacity of traditional dispensers of similar size. Helps ensure that employees, guests and tenants will not run out of product. Requires refilling half as often, saving time and money. Ideal for high-traffic, high-volume locations where frequent servicing is difficult or impractical. ADA compliant, one-hand push operation.
35400100 223008 2000 mL, Dove Gray 8/cs.



F. GOJO® PRO 2000 BAG-IN-BOX DISPENSERS **GOJO**
 Large display window shows the refill inside. ADA compliant, one-hand push operation. Sanitary Sealed™ refills are easy to load, store, and handle. Portion control helps reduce waste. Fresh dispensing valve with each refill. Constructed of high-impact ABS plastic.
35400021 720001 2000 mL, Black 1/ea.
35400091 720501 2000 mL, White 1/ea.



G. GOJO® TFX™ TOUCH FREE DISPENSERS **GOJO**
 Touch-free, trouble-free hand hygiene. Skylight makes it easy to see when it's time to reload. Dispenser turns off automatically when opened. LED light shows when battery charge is low. 30,000 uses from three standard C-size alkaline batteries (included). Fully ADA compliant, UL/CE registered.
35403014 273012 1200 mL, Black 12/cs.
35402740 274012 1200 mL, Gray 12/cs.



H. PLACES™ BOTTLE HOLDER **GOJO**
 Bracket is secured with adhesive strips that hold firmly to walls, doors, office equipment or other vertical surfaces. Removal is quick, easy and leaves no surface damage.
35409005 900512 Fits 12 oz. 12/cs.



I. PROVON® FMX-12™ FOAM SOAP DISPENSER **GOJO**
 Holds a 1250 mL sealed refill in a remarkably small footprint. Great for locations where a smaller, more traditional dispenser is preferred. Delivers more than 1,700 handwashes per refill. Features skylight with an extra-large site window. ADA compliant, one hand push operation. Optional key lock included.
35405009 516006 1250 mL, Dove Gray 6/cs.



J. PURELL® FMX-12™ FOAM SOAP DISPENSER **GOJO**
 Holds a sealed refill in a remarkably small footprint. Great for locations where a smaller, more traditional dispenser is preferred. Delivers more than 1,700 uses per refill. Features skylight with an extra-large site window. ADA compliant, one hand push operation. Optional key lock included.
35402106 512006 1250 mL, Dove Gray 6/cs.

Soap Dispensers/Amenities



A. PURELL® NXT® SPACE SAVER™ SOAP DISPENSER GOJO

Much smaller footprint than traditional 800 mL dispensers, yet holds 1000 mL of product. Fully ADA depth and push compliant.

354020061	212006	1000 mL, Dove Gray	1/ea.
35402006	212006	1000 mL, Dove Gray	6/cs.



B. PURELL® TFX™ TOUCH-FREE DISPENSER GOJO

Touch-free, trouble free dispensing system. Dispenser features a skylight with an extra-large site window that makes it easy to see when it's time to reload. Fully ADA compliant.

354020021	272012	1200 mL, Dove Gray	1/ea.
35402002	272012	1200 mL, Dove Gray	12/cs.



C. IN-SIGHT® ONEPAK SKIN CARE DISPENSER KIMBERLY-CLARK

This dispenser is curved and contemporary, creating the best impression for your restrooms. Ideal for 800 mL and 1000 mL cartridges.

15401180	91180	Smoke Gray	1/ea.
----------	-------	------------	-------



D. IN-SIGHT® SERIES-I MINI 500 SKIN CARE DISPENSER KIMBERLY-CLARK

Push lever for easy one-hand operation. Delivers a metered amount of soap through a one-way peristaltic pump, minimizing contact between product and outside environment. Holds one 500 mL soap refill cartridge. Each refill features a new pump. Keyless lock system.

15402625	92190	500 mL, Black	1/ea.
----------	-------	---------------	-------



E. SURETOUCH® REFLECTIONS SOAP DISPENSER KIMBERLY-CLARK

Counter mounted soap dispenser. Engineered to eliminate common soap dispensing problems like clogs and leaks. Polished chrome finish.

15401934	91934	3 ⁹ / ₁₀ " x 16 ² / ₅ " x 2 ¹ / ₂ ", Polished Chrome	1/ea.
----------	-------	--	-------



F. WINDOWS® ONEPAK SKIN CARE DISPENSER KIMBERLY-CLARK

This dispenser is curved and contemporary, creating the best impression for your restrooms. Ideal for 800 mL and 1000 mL cartridges.

15401086	91182	White	1/ea.
----------	-------	-------	-------



G. CLASSIC SOAP DISPENSERS SAN JAMAR

Classic bulk soap dispensers are designed to be durable and accommodate a wide variety of liquid and lotion soaps (except pumice). Large push bars allow for easy dispensing.

62571030	S30TBK	30 oz., Black Pearl	6/cs.
62574600	S46TBK	46 oz., Black Pearl	1/ea.



H. BOTTLE MOUNTED HAND SOAP PUMP ZEP

Durable, bottle mounted hand soap pump designed to deliver a generous amount of hand cleaner with or without abrasive.

750701401	R09501	Bottle Mounted Hand Soap Pump	1/ea.
-----------	--------	-------------------------------	-------



I. WALL MOUNT HAND CARE SYSTEM ZEP

Industrial grade dispensing system that offers a sleek appearance with the durability of stainless steel internal components. For 1 gal. hand care products.

75070139	R09401	Dispenser	1/ea.
----------	--------	-----------	-------



AMENITIES

J. HERBAL ESSENCES® MOISTURIZING SHAMPOO & CONDITIONER PROCTER & GAMBLE

Hello hydration is about the moisture, so let us quench your tresses with lush hydration with a fusion of orchid and coconut milk.

16901990	01990	Shampoo, 1.7 oz., Travel Size	36/cs.
16901991	01991	Conditioner, 1.7 oz., Travel Size	36/cs.



K. GILLETTE DAISY CLASSIC RAZOR PROCTER & GAMBLE

Made thinner to glide effortlessly for incredible comfort. Moisture-smooth strip releases moisturizers during each stroke. Better control handle for a secure grip.

16902507	02507	5 ct.	36/cs.
----------	-------	-------	--------





Lined area for taking notes, consisting of multiple horizontal lines.

All Purpose Floor Cleaners



ALL PURPOSE FLOOR CLEANERS

A. SPEEDEE MOP FLOOR CLEANER CARROLL

Liquid damp mop concentrate for use on high gloss floor finishes. No rinsing required when used as directed saving time and labor costs. Enhances floor appearance and prolongs life of finish. Pleasant sassafras fragrance.

30010479 10028 1 gal. 4/cs.
30010480 10019 5 gal. 1/ea.



B. SUPER SIX NEUTRAL NO-RINSE FLOOR DETERGENT CARROLL

Versatility, environmental safety and worker safety are built into this general purpose cleaner. It may be used to effectively clean floors, counters and any other surfaces not harmed by water alone. This product can be applied by trigger sprayer, mop or automatic floor scrubbing machines. This gentle but effective general purpose cleaner is ideal for the daily maintenance of schools, offices, institutions and other public facilities. It features "no-rinse" ease in most cleaning applications. Use to clean surfaces such as plastic, metal, laminates, glass, vinyl, walls and more.

30010139 12628 1 gal. 4/cs.



C. FLOOR SCIENCE® FLOOR CLEANER DIVERSEY

Rinse-free formula saves labor by eliminating a separate rinsing step. Leaves no residue to dull the finish. Helps extend stripping and recoating cycle. Low-foaming formula can be used in auto scrubbers for maximum efficiency.

15206792 96792 1 gal. 4/cs.



D. REVIVE® PLUS SC UHS CLEANER & MAINTAINER DIVERSEY

Unique patented cleaner/maintainer formula can be used for daily cleaning. Floor stays cleaner, longer. Unique formula designed to repair microscopic scratches.

15204619 2974600 32 oz., Accumix™ 6/cs.

E. UHS™ SC FLOOR CLEANER DIVERSEY

Improved cleaning performance, wetting and deep scrubs more consistently.

15204525 4529489 32 oz., Accumix™ 6/cs.



F. HOT SPRINGS® GENERAL PURPOSE CLEANER DIVERSEY

Great for spray and wipe, mop and bucket, or autoscrubber applications. Excellent for scrubbing floors before recoating finish. Strong formula, cleans without caustics, solvents, or phosphates. Great for daily cleaning of unfinished tile in high-soil areas. Fresh, clean fragrance. Dilutions: 1:16 Extra Heavy Cleaning And For Scrub And Recoat, 1:32 Heavy Cleaning, 1:64 Medium Cleaning, 1:128 Light Cleaning.

57089110 4039110 1 gal. 4/cs.

G. MR. CLEAN® FINISHED FLOOR CLEANER PROCTER & GAMBLE

Excellent cleaning and shine preservation for a wide range of finished floors including ceramic and vinyl tile, terrazzo, and varnished hardwood. Can be used as a versatile all purpose cleaner. Contains ingredients to cause the rapid collapse of its suds, making it an excellent choice for use in automatic floor scrubbing machines. Contains an optimized blend of nonionic and anionic surfactants designed to help maximize soil removal. Use it diluted (1 fl. oz. per 1 gallon) or for full-strength cleaning.

16902621 02621 1 gal. 3/cs.

H. SPIC AND SPAN® FLOOR CLEANER PROCTER & GAMBLE

Saves the time and effort of rinsing. Cuts through grease and tracked-in soils to minimize the need for multiple floor treatments.

16900130 02011 3 oz. Packet 45/cs.
16900129 02001 1 gal. 3/cs.



I. SPIC AND SPAN® FLOOR CLEANER W/BLEACH PROCTER & GAMBLE

Cuts tough greasy soil and bleaches out stains. Helps fight tough floor stains with the power of chlorine bleach. Available in portion packs, cutting down on employee waste.

16902010 02010 2.2 oz. Packet 45/cs.

HARD FLOOR CARE

All Purpose Floor Cleaners/Wood Cleaners



HARD FLOOR CARE

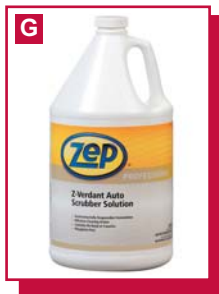
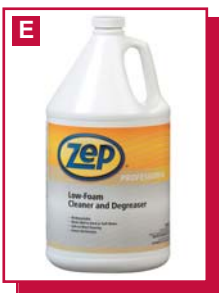

A. TIDE® ALL PURPOSE/FLOOR CLEANER PROCTER & GAMBLE

Heavy-duty floor and all purpose cleaner. Economical and versatile powdered cleaner cuts through tough grease and attacks tracked-in dirt. Can be used with chlorine bleach. Non-phosphate. Classified by UL for slip resistance 43R9.

16901801	02370	1.5 oz.	100/cs.
16900913	08171	18 lb.	1/ea.
16902364	02364	36 lb.	1/ea.

B. MOP & GLO® MULTI-SURFACE FLOOR CLEANER RECKITT BENCKISER

Multi-surface floor cleaner with Shine Lock™ formula cleans your floors and leaves behind a long lasting shine in one quick and convenient step. Safe to use on tile, vinyl, hardwood, marble, linoleum, ceramic and no wax floors.

58345432	75057	32 oz.	6/cs.
58344297	74297	64 oz.	6/cs.

C. AUTOMATIC FLOOR SCRUBBER SOLUTION ZEP

Heavy-duty, low foaming concentrated formula for auto scrubber and other industrial cleaning applications. Removes soils from smoke and fire damage. Ideal for use in pressure washers. Contains optical brighteners to brighten surfaces as it cleans.

75070042	R03024	1 gal.	4/cs.
75070043	R03035	5 gal.	1/ea.

D. BROAD SPECTRUM DISINFECTANT FLOOR CLEANER ZEP

Environmentally preferred neutral floor and hard surface cleaner. Hospital grade disinfectant eliminates bacteria, fungi and viruses including HIV, MRSA, and Staph.

75070027	R02124	1 gal.	4/cs.
75070028	R02135	5 gal.	1/ea.

E. LOW-FOAM CLEANER & DEGREASER ZEP

General-purpose, low-foam cleaner and degreaser works rapidly and rinses away easily. May be used in an auto scrubber for routine cleaning.

75070046	R03224	1 gal.	4/cs.
75070047	R03235	5 gal.	1/ea.

F. Z-VERDANT ALL PURPOSE CLEANER ZEP

Environmentally preferred, concentrated all purpose cleaner. May be used on any surface not harmed by water. May be used for most daily cleaning and maintenance operations. Contains no harmful solvents or harsh chemicals.

75070133	R08924	1 gal.	4/cs.
75070134	R08935	5 gal.	1/ea.

G. Z-VERDANT AUTO SCRUBBER SOLUTION ZEP

Environmentally preferred auto scrubber concentrate. Removes oil, grease, and dirt from floors and most other washable surfaces. Biodegradable, no petroleum, solvents or caustics.

75070129	R08724	1 gal.	4/cs.
75070130	R08735	5 gal.	1/ea.

WOOD CLEANERS

H. MURPHY® OIL SOAP COLGATE-PALMOLIVE

Economical, natural cleaner is ideal for mopping wood floors, paneling and other large wood surfaces. Naturally cleans finished and hard surfaces. EPA DfE approved formula.

11901101	01101	16 oz.	12/cs.
11902106	01106	32 oz., Concentrate	12/cs.
11900185	01185	32 oz., Trigger Sprayer	12/cs.
11900103	01103	1 gal., Concentrate	4/cs.

I. MOP & GLO® WOOD FLOOR CLEANER RECKITT BENCKISER

Quick, convenient one-step process cleans away the dirt and leaves a beautiful shine that provides long-lasting protection. Protects against wear and tear. Recommended for use on sealed wood floors.

58345065	75065	32 oz.	6/cs.
----------	-------	--------	-------

Dust Mopping/Concrete Cleaners/Tile & Stone Cleaners



DUST MOP TREATMENTS

A. PRIME SOURCE® DUSTY MOP TREATMENT PRIME SOURCE®

Water-based formula leaves floor clean and shiny. No silicones or waxes that leave a slippery coating. Attracts dirt and dust like a magnet.

75004510 75004510 18 oz. 12/cs.

B. DUSTER PLUS® DUSTING SPRAY DIVERSEY

Dusts and leaves a shine on wood, resilient floors, even stainless steel. Works like a magnet to remove dust, oil-based and water-based smudges and stains. Can also be used as a dust mop treatment. Picks up dust rather than scattering it, so you dust less often. Fresh lemon fragrance. Contains no CFCs. Multi-surface: Can be used on everything from furniture to floors, blinds to artificial plants, books to baseboards.

15200074 94752 17 oz. 6/cs.



CONCRETE CLEANERS

C. ALL-OFF CONCRETE CLEANER/DEGREASER CARROLL

Removes difficult soils from concrete floors and driveways. Special color change agents identify area of product coverage. Orange color turns green when wet. Pine oil added to aid in emulsification and cleaning. Clean pine fragrance.

30010176 95010 50 lb. 1/ea.

D. EXTERIOR/INTERIOR MASONRY SEALER ZEP

Water-resistant acrylic formulation protects concrete and masonry surfaces from oil stains and UV rays. Apply with a mop or roller and allow to dry.

75070062 R04124 1 gal. 4/cs.

75070063 R04135 5 gal. 1/ea.

E. HEAVY-DUTY CONCRETE & MASONRY CLEANER ZEP

Fast, effective, concentrated floor cleaner for concrete, masonry, tile and brick floors. Ideal for automatic floor scrubbing equipment or mop application.

75070048 R03324 1 gal. 4/cs.

75070049 R03335 5 gal. 1/ea.

F. HEAVY-DUTY POWDERED CONCRETE CLEANER ZEP

Fast-acting, powerful concrete cleaner changes color when wet to indicate concentration. Easy-to-use, biodegradable.

75070040 R02934 40 lb. 1/ea.

75070041 R02942 125 lb. 1/ea.

G. Z-TREAD FLOOR SEALER ZEP

Concrete, terrazzo, and resilient floor sealer provides excellent clear gloss basecoat for any floor finish. Levels out quickly to leave no streaks or mop trails.

75070060 R04024 1 gal. 4/cs.

75070061 R04035 5 gal. 1/ea.



TILE & STONE CLEANERS

H. PRIME SOURCE® Q-T-C QUARRY TILE CLEANER PRIME SOURCE®

Rapidly removes grease and grime from quarry tile and grout surfaces. Improves slip resistance of floor.

75004493 75004493 1 gal. 4/cs.

I. QUARRY TILE CLEANER CARROLL

Removes slippery grease and soapy build up from quarry tile and concrete. Deep cleans by penetrating and reopening floor pores, water-based. Ideal for restaurants and institutional food service kitchens, concentrated. No fragrance added. USDA A3.

30010457 32528 1 gal. 4/cs.



HARD FLOOR CARE

Tile & Stone Cleaners/Floor Stripper



HARD FLOOR CARE



A. SURE TRAC® ULTRA FLOOR CLEANER & TRACTION TREATMENT **DIVERSEY**
 Penetrates deep into tile pores and grout to lift imbedded soils and grease, improving slip-resistance with repeated use. Also effective on concrete, ceramic tile, vinyl and resilient tile floors.
 15200013 90228 1 gal. 2/cs.



B. IRON STONE™ ACRYLIC SEAL **DIVERSEY**
 Acrylic seal for stone and porous surfaces. Excellent leveling and adhesive characteristics, even on worn surfaces. Superior compatibility with a wide range of stone surfaces and strips easily. Reduces scuffing and marking. Protects against soil penetration and staining.
 57086110 4006110 1 gal. 4/cs.



C. PRIME SOURCE® REVEAL NON-AMMONIA STRIPPER **PRIME SOURCE®**
 Heavy-duty formula. Odor-free. Does not contain butyl cellulose.
 75004504 75004504 1 gal. 4/cs.
 75004505 75004505 5 gal. 1/ea.
 75004506 75004506 55 gal. 1/ea.



D. PRIME SOURCE® STRIP-EEZ BASEBOARD & EDGE CLEANER **PRIME SOURCE®**
 Strong, foaming cleaner. Emulsifies heavy wax build-up. Clings to vertical surfaces.
 75004476 75004476 19 oz. 12/cs.



E. PRIME SOURCE® SUPER STRIP-EEZ LIQUIFYING STRIPPER **PRIME SOURCE®**
 No-rinse, solvent-based stripper that quickly penetrates and liquifies multiple layers of floor finish for complete removal.
 75004477 75004477 1 gal. 4/cs.
 75004478 75004478 5 gal. 1/ea.



F. ENVIROPATROL® WAX & FINISH REMOVER **CARROLL**
 When used as directed, this product is a high performance, ultra low odor, non-toxic, non-corrosive, butyl-free, ammonia-free wax and finish remover. Specially designed to remove conventional zinc crosslinked finishes as well as environmentally preferable zinc-free floor finishes like EnviroPatrol® Metal Free Floor Finish. A highly concentrated rapid response stripper that dissolves multiple coats of finish without the strong and unpleasant odor associated with conventional strippers. Rinses quickly without leaving residual alkali to interfere with finish application. Dilute 1 part to 6 parts of cold water for most applications. This product has been 3rd party certified by Green Seal® according to GS-40 Environmental Standard and is recognized by the U.S. Environmental Protection Agency Design for the Environment (DfE) Formulator Initiative. Cold water effective.
 30011276 35028 1 gal., AE, Green Seal® (DfE) 4/cs.
 30011274 35019 5 gal., Green Seal® (DfE) 1/ea.



G. SALVO NON-AMMONIATED FLOOR STRIPPER **CARROLL**
 Non-ammoniated, concentrated, re-liquefying stripper. Quickly and completely removes floor finish with little or no agitation. Can be used as a mop-on, pick up stripper. Water based solvent system.
 30011028 31028 1 gal. 4/cs.



H. SUPER STRIP PLUS EMULSIFYING STRIPPER **CARROLL**
 Non-ammoniated, very aggressive floor finish emulsifier. Completes job with first application, saving time and labor costs. Effective on heavily burnished finishes and chemical resistant sealers. Water based solvent system.
 30010472 30828 1 gal. 4/cs.

Floor Stripper/Neutral Floor Cleaners



A. BRAVO® 1500+ FLOOR STRIPPER DIVERSEY

Specially formulated for high and ultra high speed floor care programs. Quickly penetrates and emulsifies finish.

15206341 4956341 5 gal. Envirobox™ 1/ea.



B. BRAVO® HEAVY-DUTY STRIPPER DIVERSEY

Heavy-duty for today's tough build-ups and burnished finishes. Excels with superior wetting, penetration and emulsification properties. Non-ammoniated, phosphate-free, pleasantly scented.

15205958 5115958 5 gal. Envirobox™ 1/ea.



C. FLOOR SCIENCE® FLOOR STRIPPER DIVERSEY

Extra heavy-duty formula cuts through multiple coats to save labor and stripping time, even on frequently burnished or spray buffed surfaces. Non-ammonia, non-solvent formula means no harsh odors. Rinses freely from floor surfaces to help assure good adhesion of the new finish.

15200099 98726 1 gal. 4/cs.



D. FREEDOM® SC STRIPPER DIVERSEY

Saves up to one-half the time and labor vs. ordinary stripping procedures. No machine, stripping pads, neutralizers, or multiple rinses. Use with a machine for those problem build-ups, too. Non-ammoniated. Solvenated. Amber in color with a slight solvent scent.

15206424 3685931 1.5 L 1/ea.



E. PRO STRIP® EXTRA HEAVY-DUTY STRIPPER DIVERSEY

Specially formulated to penetrate and emulsify the toughest UHS burnished finishes. Pleasantly scented, solvenated stripper.

15205032 5032360 5 gal. Envirobox™ 1/ea.



F. Z-TREAD BASEBOARD STRIPPER ZEP

Heavy-duty, fast-acting, aerosol floor finish remover. Great for stripping around baseboards and other hard-to-reach areas. Inverted can design for ease-of-use.

75070059 R03901 20 oz. 12/cs.



G. Z-TREAD HEAVY-DUTY FLOOR STRIPPER ZEP

Heavy-duty, low-foaming stripper designed to quickly remove heavy floor finish buildup without the need for scrubbing. Will strip away multiple coats of finish. Free rinsing.

75070044 R03124 1 gal. 4/cs.

75070045 R03135 5 gal. 1/ea.



NEUTRAL FLOOR CLEANERS

H. PRIME SOURCE® NU-VIEW LOW FOAM NEUTRAL CLEANER PRIME SOURCE®

Low foaming. Ideal for use in automatic scrubbers. Neutral pH formula. Film and residue-free cleaning.

75004004 75004004 1 gal. 4/cs.

75004005 75004005 5 gal. 1/ea.

75004006 75004006 55 gal. 1/ea.

76008500 76008500 3.78 L 4/cs.

76008501 76008501 18.9 L 1/ea.



I. ENVIROPATROL® NEUTRAL CLEANER CARROLL

Use as a highly efficient multi-use cleaner for floors, walls, woodwork and other washable surfaces where a neutral pH range is desirable. Quickly removes soil without dulling, damaging, etching, or harming floor finishes even when used for daily applications. Dilutes at 1 oz./gal. (1:128) for most applications. This product has been 3rd Party Certified by Green Seal® according to GS-37 Environmental Standard and is recognized by the U.S. Environmental Protection Agency Design for the Environment (DfE) Formulator Initiative for its improved environmental and human health characteristics. Cold water effective.

30011272 12728 1 gal., Green Seal® (DfE) 4/cs.



Neutral Floor Cleaners/Floor Finish



HARD FLOOR CARE



A. FORMULA 409® NEUTRAL FLOOR CLEANER CLOROX

Designed to clean a wide range of soils on a wide variety of floor surfaces. Loosens and removes tough soils, including foodservice kitchen soils. No rinsing required, saving time and labor. Leaves floors sparkling with no dulling film on the surface. UL classified for slip resistance. Fresh citrus scent. pH neutral and low foaming. Specially formulated for use with floor machines and automatic scrubbers.

38388738 14805 1 gal. 4/cs.

B. EASY PAKS® NEUTRAL CLEANER DIVERSEY

Loosens and removes soil while protecting high gloss finishes. Leaves no dulling film, even without rinsing. For surfaces ranging from terrazzo, marble, slate and vinyl to asphalt, ceramic tile, quarry tile, terrazzo, marble, concrete, painted surfaces and vinyl.

15200107 90653 (90) 1/2 oz. Packets 180/cs.

C. STRIDE® CITRUS NEUTRAL CLEANER DIVERSEY

A neutral cleaner concentrate formulated for everyday cleaning of floors and other hard surfaces. This product does not dull floor finishes, and does not require rinsing to deliver labor savings. Orange in color with a citrus scent. 1:256 dilution.

15203390 3063390 5 L 1/ea.

D. MASTERPIECE® NEUTRAL CLEANER RECKITT BENCKISER

Provides effective, low-foaming, rinse-free cleaning without stripping or reacting with the floor surface. Contains no alkalis, phosphates or ammonia. Can be used on conductive flooring, will not reduce floor conductive properties. Use in facilities where effective cleaning with mop-on or autoscrubber application is desirable. Economical, concentrated formula makes up to 64 gallons (1:64). Neutral pH at 1:64 dilution. Authorized under USDA Registration C-1 standards for use in federally inspected meat and poultry facilities.

58344454 74454 1 gal. 4/cs.

E. Z-TREAD NEUTRAL FLOOR CLEANER ZEP

Low-foam, general-purpose floor cleaner. May be mop applied or used in automatic floor scrubbers. Rinses easily. Neutral pH will not harm floor finishes.

75070050 R03424 1 gal. 4/cs.
75070051 R03435 5 gal. 1/ea.

FLOOR FINISH

F. PRIME SOURCE® DAZZLE BRIGHT GLOSS FINISH PRIME SOURCE®

Flexible film. Fast drying and multi-speed buffable. Produces a wet look gloss.

75004501 75004501 1 gal. 4/cs.
75004502 75004502 5 gal. 1/ea.
76008525 76008525 3.78 L 4/cs.
76008526 76008526 18.9 L 1/ea.

G. PRIME SOURCE® GROUND LEVEL SEALER/FINISH PRIME SOURCE®

Fast drying. All acrylic formulation.

75004487 75004487 1 gal. 4/cs.
75004488 75004488 5 gal. 1/ea.
76008523 76008523 3.78 L 4/cs.
76008524 76008524 18.9 L 1/ea.

H. PRIME SOURCE® MIRAGE HIGH GLOSS FINISH PRIME SOURCE®

High solids with extra durability. Extra-hard wear surface. Produces an initial high gloss.

75004507 75004507 1 gal. 4/cs.
75004508 75004508 5 gal. 1/ea.
76008544 76008544 3.78 L 4/cs.
76008545 76008545 18.9 L 1/ea.

Floor Finish



A. PRIME SOURCE® REFLECTIONS 250 HIGH SPEED FINISH PRIME SOURCE®

Designed for UHS floor maintenance. Produces a dazzling gloss. Extra wear and durability.

75004480	75004480	1 gal.	4/cs.
75004481	75004481	5 gal.	1/ea.
75004482	75004482	55 gal.	1/ea.



B. PRIME SOURCE® SHINE-ON UHS RESTORER/SPRAY BUFF PRIME SOURCE®

3-in-1 formulation that can be used as a spray buff, mop-on restorer, or through an auto scrubber. This cleaner/restorer enhances the gloss on any floor finish.

75004496	75004496	32 oz.	12/cs.
75004490	75004490	1 gal.	4/cs.
76008519	76008519	3.78 L	4/cs.



C. PRIME SOURCE® VISIONS WET LOOK FINISH PRIME SOURCE®

Flexible film. Fast drying and multi-speed buffable. Produces a wet look gloss.

75004483	75004483	1 gal.	4/cs.
75004484	75004484	5 gal.	1/ea.
76008517	76008517	3.78 L	4/cs.
76008518	76008518	18.9 L	1/ea.



D. ENVIROPATROL® METAL FREE FLOOR FINISH CARROLL

Designed with the newest in environmentally preferable metal-free polymer technology for sealing and finishing all types of resilient flooring. Does not contain zinc, phthalates or alkyl phenol ethoxylates. This state-of-the-art finish has exceptional gloss, durability, soil resistance, detergent resistance, recoatability, removability, and slip resistance. A combination sealer and finish that dries to a smooth, hard, clear and colorless coating in about 30 minutes under normal conditions. Third party certified by Green Seal® according to GS-40 Environmental Standard and is recognized by the U.S. Environmental Protection Agency Design for the Environment (DfE) Formulator Initiative. Cold water effective.

30016728	66728	1 gal., AE, Green Seal® (DfE), Metal-Free	4/cs.
30010667	66719	5 gal., AE, Green Seal® (DfE), Metal-Free	1/ea.
30011275	66719	5 gal., AE, Green Seal® (DfE), Enviro Patrol	1/ea.



E. LEVEL BEST® HIGH SOLIDS FLOOR POLISH CARROLL

Ultra high solids; excellent gloss, slip resistance and durability. Flexible metal cross-linked finish. Single coat acts as sealer and finish, reducing labor costs. Non-yellowing, non-powdering; regular or high speed burnishing.

30010084	69028	1 gal.	4/cs.
----------	-------	--------	-------



F. POLARIS ULTRA PREMIUM UHS FLOOR FINISH CARROLL

Ultra high solids formula requires fewer coats saving time and labor. Designed for high traffic areas with excellent gloss and scuff resistance. Extremely durable which extends recoating and strip-out cycles, reducing labor costs. UHS formulated for compatibility with UHS propane, battery, and electric equipment. SPT - synergistic polymer technology formulated for durability and "wet look" gloss.

30010213	62328	1 gal.	4/cs.
30010214	62319	5 gal.	1/ea.



G. PRO-TRACT SEALER/FINISH CARROLL

New technology finish designed for use in high traffic areas. Combines brilliant high gloss, outstanding durability and excellent slip resistance. Unique polymer system is easy to use and provides even application. Use with any speed buffer or burnisher (including propane).

30010080	67719	5 gal.	1/ea.
----------	-------	--------	-------



H. TEN® FLOOR FINISH CARROLL

Innovative terpolymer technology offers performance value. Designed to protect, preserve, and enhance flooring. Easy to apply, repair and recoat. High initial gloss is also long lasting and buffable.

30010081	68028	1 gal.	4/cs.
----------	-------	--------	-------



HARD FLOOR CARE

Floor Finish



HARD FLOOR CARE



A. AMPLIFY™ FLOOR FINISH DIVERSEY

High solids durable finish. Superior initial gloss. Builds gloss with fewer coats than other finishes. Applies easily and levels perfectly with no mop drag. Great mark resistance and durability. Excellent response to spray buffing or UHS burnishing. White in color with a mild scent.

15204715 5104714 5 gal. Envirobox™ 1/ea.

B. COMPLETE™ METAL INTERLOCK FLOOR FINISH DIVERSEY

A durable finish that reduces the need to strip and refinish. Responds beautifully when spray buffed. Resists black heel marks, scuffs, dirt penetration and detergents. Dries clean with a tough, long lasting gloss.

15204649 4649 1 gal. 4/cs.
15200441 5104773 5 gal. Envirobox™ 1/ea.

C. FLOOR SCIENCE® FINISH DIVERSEY

Premium universal sealer/finish. Synthetic polymer floor finish/sealer produces a "wet look" high gloss. Repairs easily in minimal time and resists scuffs and scratches. For conventional, high speed and ultra high speed floor machines. Dries fast, no sealer required. For resilient and non-resilient floors. Universal applications—can be used on vinyl, vinyl composition, vinyl asbestos, asphalt tile and rubber, as well as terrazzo, marble, slate, unglazed ceramic and quarry tile, brick and granite.

15200098 98391 1 gal. 4/cs.
15208391 98390 5 gal. BIB 1/ea.

D. FLOOR SCIENCE® SPRAY BUFF DIVERSEY

Cleans and restores the high gloss "wet look" of Floor Science® Finish (sold separately). Premium performance—cleans, shines, removes heel marks, scratches, tar and ingrained dirt. Leaves a brilliant shine without build-up or discoloration. Effective with low speed or high speed floor machines. Works in minimal time.

15206896 96896 1 gal. 4/cs.

E. HIGH MILEAGE FLOOR FINISH DIVERSEY

High-solids, low-odor UHS floor finish provides optimized gloss build and offers black heel mark/scratch resistance. Up to five coats can be applied in one application without signs of stressing. Finish performs well in less-than-ideal environmental conditions such as high or low humidity. Its properties make it suited for 24-7 facilities such as hospitals or retail environments with busy aisles and hallways.

15200440 5104811 5 gal. Envirobox™ 1/ea.

F. MAINSTAY® LOW MAINTENANCE FLOOR FINISH DIVERSEY

High performance finish for infrequent maintenance. Great durability, requires less frequent recoating. Excellent mark, scuff and scratch resistance. Responds very well to spray buff maintenance and to UHS burnishing.

15204917 5104917 5 gal. Envirobox™ 1/ea.

G. PLAZA™ PLUS HARD SURFACE SEALER/FINISH DIVERSEY

Use on terrazzo, quarry tile, brick, slate, granite, marble, unglazed ceramic and Mexican tile. Exhibits exceptional gloss, leveling and long Lasting durability. Easy to maintain in conventional and UHS programs. White in color with a slight ammonia scent.

15203866 4168 1 gal. 4/cs.

H. REVIVE® UHS MAINTAINER DIVERSEY

Formulated for daily use and doesn't require burnishing after each application. Use through an auto scrubber or with mop and bucket.

15209708 4636 5 gal. Envirobox™ 1/ea.

I. SHOW PLACE™ HIGH GLOSS FLOOR FINISH DIVERSEY

Brilliant, long-lasting, high-gloss 25% solids finish for the ultimate in prestige floors. Extraordinary responsiveness to both conventional and UHS programs. A user-friendly and high-performance solution. Off-white in color with an ammonia scent.

15200439 5120888 5 gal. Envirobox™ 1/ea.

Floor Finish



A. SIGNATURE® UHS FLOOR FINISH DIVERSEY

For wet-look appearance throughout your establishment. Unsurpassed wet-look gloss. Dramatic response to propane, battery, and electric equipment. Designed to excel on vinyl composite, sheet vinyl and terrazzo flooring. Easy to apply, thin or full coats, fast drying. Dry time is 30-45 minutes under normal conditions. Meets ASTM D2047 requirements for slip resistance.

15200435 5104950 5 gal. Envirobox™ 1/ea.



B. SNAPBACK™ SPRAY BUFF DIVERSEY

For conventional maintenance systems. Gives you that just-finished shine. Keeps your floors looking their best at all times. Delivers state-of-the-art performance and cost efficiency.

15204116 4116 1 gal. 4/cs.



C. VECTRA® HIGH PERFORMANCE FLOOR FINISH DIVERSEY

A floor finish that saves you time, while giving your floors a diamond-like brilliance, clarity and durability. Provides better buff response. Cures on the floor faster than traditional floor coatings. Resists dirt embedment and black heel marks. Resists scratching and scuffing. Works with UHS equipment. Responds well to 175 - 1500 rpm equipment.

15203863 4078 1 gal. 4/cs.

15200434 5105047 5 gal. Envirobox™ 1/ea.



D. HIGH NOON™ UHS FLOOR FINISH DIVERSEY

Ultra-durable UHS finish is built with tough all-acrylic polymers and fortified with urethane for unmatched durability. Burnishes to a rich deep gloss. Reduces labor costs by extending recoat and strip-out cycles. Retains good looks longer between burnishing.

57084829 5104829 5 gal. Envirobox™ 1/ea.



E. SPEEDTRACK® FLOOR RESTORER DIVERSEY

One-step clean and burnish restorer. Unique "liquid thermoplastic polymer" reduces powdering, improves traction and extends recoat cycle. Burnishes to a high shine. Can be used in autoscrubbers and in mop and bucket applications.

57083110 4033110 1 gal. 4/cs.



F. MASTERPIECE® HIGH GLOSS FLOOR FINISH RECKITT BENCKISER

High gloss floor finish is repairable without the need for a restorer, just clean and burnish or recoat and burnish. Use in facilities that demand a high-profile, "wet look" shine.

58340009 03905 5 gal. 1/ea.



G. Z-TREAD BURNISH RESTORER ZEP

Environmentally preferred, concentrated floor gloss restorer cleans and prepares floor for burnishing in one easy step. Eliminates need for frequent stripping and refinishing.

75070057 R03824 1 gal. 4/cs.

75070058 R03835 5 gal. 1/ea.



H. Z-TREAD HIGH SOLIDS FLOOR FINISH ZEP

High-gloss 25% solids floor finish produces high gloss with fewer coats. Designed to provide a wet look with bi-weekly ultra high speed burnishing. Resists scuffs and black heel marks.

75070055 R03724 1 gal. 4/cs.

75070056 R03735 5 gal. 1/ea.



I. Z-TREAD SPRAY BUFF SOLUTION ZEP

Ready-to-use spray buff formulation cleans and rejuvenates most types of floor finishes. Eliminates need for frequent stripping and refinishing. Restores gloss and repairs scratch marks. Great for spot burnishing and daily maintenance on high gloss finishes.

75070064 R04201 1 qt. 12/cs.

75070065 R04224 1 gal. 4/cs.



J. Z-TREAD UHS FLOOR FINISH ZEP

High-gloss, 20% solids floor finish, designed to provide a wet look with weekly ultra high speed burnishing. Resists scuffs and black heel marks.

75070053 R03624 1 gal. 4/cs.

75070054 R03635 5 gal. 1/ea.



HARD FLOOR CARE



Floor Finish/Absorbent/Ice Melters



A. Z-TREAD UTILITY FLOOR FINISH ZEP

Versatile 20% solids floor finish designed for high gloss and durability. Compatible with low maintenance, spray buffing, or weekly ultra high speed burnishing.

75070066	R04324	1 gal.	4/cs.
75070067	R04335	5 gal.	1/ea.



ABSORBENT

B. SWEEPING COMPOUND ZEP

All-purpose compound for use on hard floors. May be used in all sweeping operations.

75070052	R03555	250 lb.	1/ea.
----------	--------	---------	-------



ICE MELT

C. ROAD RUNNER ICE MELT SCOTWOOD INDUSTRIES

A blend that contains calcium and magnesium chloride pellets. Recognized as one of the most effective blends on the market. Begins melting immediately upon impact, generates melting heat fast. Effectively melts ice down to -15°F. Needs fewer applications than rock salt. Safe on streets, driveways, sidewalks, steps and the environment when applied correctly. Does not track. Odorless and colorless.

16770011	RR12	12 lb. Jug	1/ea.
16770014	RR50	50 lb. Bag	1/ea.
16770013	RR50BOX	50 lb. Box	1/ea.
16770008	RR50PAIL	50 lb. Pail	1/ea.
16770017	RR100BOX	100 lb. Box	1/ea.



D. ROCK SALT ICE MELTER SCOTWOOD INDUSTRIES

Sodium chloride granules are a safe and economical choice for melting ice and snow. Effective in cold temperatures and melts to 25°F. Rock salt prevents ice from accumulating and leaves a safe clean surface.

167700509	RS50	50 lb. Bag	1/ea.
-----------	------	------------	-------



E. TRACTION MELT™ ICE MELT SCOTWOOD INDUSTRIES

Advanced formula with corrosion inhibitor. Each granule is encapsulated by liquid magnesium chloride for fast acting, environmentally friendly ice control. Corrosion inhibitor added to reduce damage to metal surfaces. Ideal for icy situations on the road where additional traction is needed. Effective in cold temperatures; melts ice down to 0°F. Safe on streets, driveways, sidewalks, steps and the environment when used correctly.

16770019	TM50BAG	50 lb. Bag	1/ea.
----------	---------	------------	-------

HARD FLOOR CARE

Carpet Cleaners



CARPET CLEANERS

A. PRIME SOURCE® RENEW HEAVY-DUTY EXTRACTION CLEANER PRIME SOURCE®

Neutral pH base. Safe for fifth generation carpeting. Clean fresh scent. Low foaming; saves time and money.
75004087 75004087 1 gal. 4/cs.



B. PRIME SOURCE® ROYAL ROTARY DRY FOAM SHAMPOO PRIME SOURCE®

Neutral pH base. Safe for fifth generation carpeting. Clean fresh scent. Prevents resoiling; carpet retains showcase appearance.
75004085 75004085 1 gal. 4/cs.



C. PRIME SOURCE® SPIN-OFF BONNET & TRAFFIC LANE CLEANER PRIME SOURCE®

Neutral pH base; safe for fifth generation carpeting. Clean fresh scent. Dries rapidly; cleaned areas may be reopened to traffic with little downtime.
75004086 75004086 1 gal. 4/cs.



D. QUICK DRAW® STEAM MACHINE SHAMPOO CARROLL

Low foaming, convenient to use steam-type extraction shampoo. Optical brighteners and soil retardants added. Penetrates and suspends soils for easy removal. Blue color; clean lemon fragrance.
30010122 23028 1 gal. 4/cs.



E. EXTRACTION CLEANER DIVERSEY

Use as a prespray, bonnet buff or extraction cleaner. Low foam formula works with today's high pressure extractors. Contains corrosion inhibitors to protect equipment.
15200001 3844 1 gal. 4/cs.



F. FOUNTAINHEAD® 128 CARPET EXTRACTION CLEANER DIVERSEY

Formulated with powerful detergents and sequestrants for fast and effective cleaning. Cleans without forming alkaline deposits that clog extractor jets. Fresh fragrance. WoolSafe™ approved.
57081112 4351110 1 gal. 4/cs.



G. PROFESSIONAL RESOLVE® CARPET EXTRACTION CLEANER RECKITT BENCKISER

One product, one dilution for three cleaning uses: carpet extraction cleaner, traffic lane cleaner and pretreatment spray. Perfect for a scheduled maintenance plan for surface and deep, down-to-the-backing cleaning. Low foaming, cleans and deodorizes. Contains strong grease-cutting agents. Economical, concentrated formula makes up to 64 gallons (1:64).
58347161 97161 1 gal. 4/cs.



H. SIMPLE GREEN® CLEAN BUILDING™ CARPET CLEANER CONCENTRATE SIMPLE GREEN

Formulated especially for cleaning carpets and rugs. Green Seal® certified and also certified by the Carpet and Rug Institute. Carpet warranties that call for the use of only CRI-approved products will not be jeopardized. No added fragrance or volatile organic ingredients. Non-toxic, biodegradable, non-caustic, and non-flammable. Makes 22 gallons of ready-to-use cleaner.
73431301 11301 1 gal., Green Seal® 2/cs.



I. CARPET PRE-TREATMENT SOLUTION ZEP

Ready-to-use, water-based carpet cleaning formula penetrates carpet soils and separates them from fibers. Low foam formula will not disrupt extraction carpet cleaning. Safe on stain resistant treated carpets.
75070017 R01201 1 qt. 12/cs.
75070018 R01235 5 gal. 1/ea.



CARPET CARE

Carpet Cleaners/Stain Removers/Spotters



A. HIGH FOAM CARPET SHAMPOO ZEP

Environmentally preferred carpet shampoo designed for deep cleaning. "Dry" foam allows for rapid drying and a quicker return to use. Inhibits surface resoiling and leaves behind a fresh fragrance. Safe on stain-resistant treated carpets.

75070015	R01124	1 gal.	4/cs.
75070016	R01135	5 gal.	1/ea.



B. LEMONGRASS CARPET EXTRACTION SOLUTION ZEP

Environmentally preferred carpet cleaner with light lemongrass fragrance. Designed for hot water extraction or bonnet method carpet cleaning. Safe on stain-resistant treated carpets. Friable surfactants dry to a powder which are easily vacuumed up, leaving no residue behind. Concentrated.

75070009	R00624	1 gal.	4/cs.
75070010	R00635	5 gal.	1/ea.



C. PRIME SOURCE® NATURE'S CLEANER DEODORIZER/SPOTTER/DIGESTER PRIME SOURCE®

Multi-purpose. Blended with multiple, non-pathogenic bacterial strains. Contains over 100 billion bacteria per gallon. Destroys uric acid and odor-causing bacteria.

75004072	75004072	1 qt.	12/cs.
75004075	75004075	1 gal.	4/cs.
75004076	75004076	55 gal.	1/ea.



D. PRIME SOURCE® SPOT UP CARPET SPOT REMOVER PRIME SOURCE®

Neutral pH base. Safe for fifth generation carpeting. Clean fresh scent. Penetrates oil, grease and dry soil, then releases onto the brush or cloth.

75004083	75004083	1 qt.	12/cs.
75004084	75004084	1 gal.	4/cs.



E. PRIME SOURCE® STAINOUT FOAMING CARPET CLEANER PRIME SOURCE®

Water-based formula. Safe for carpets and upholstery. For tough stains and small area cleaning.

75004081	75004081	18 oz.	12/cs.
----------	----------	--------	--------



F. GENERAL PURPOSE SPOTTER DIVERSEY

All purpose water-based spotter. Low residue formula will not resoil your carpet. Gets out tough stains...even the old ones. Safe on all carpets including wool.

15204192	4192	32 oz.	6/cs.
----------	------	--------	-------



G. PROFESSIONAL RESOLVE® SPOT & STAIN CARPET CLEANER RECKITT BENCKISER

Cleans the toughest spots and stains. Effective against most food and grease based stains. Can be used as a traffic lane cleaner and pre-treatment spray. Safe on wool and synthetic carpets and on stain resistant rugs.

58347402	97402	32 oz.	12/cs.
----------	-------	--------	--------



H. RESOLVE® DUAL POWER SPOT CARPET CLEANER RECKITT BENCKISER

Oxi Action stain fighters. Unites two liquid stain removal agents; a stain fighter and an oxygen activator that activate when combined and fizz and bubble deep into the stain. It begins to breakdown and dissolve a wide variety of tough stains like red wine, grape juice and food grease, right before your eyes.

58347873	77873	22 oz.	12/cs.
----------	-------	--------	--------

Stain Removers/Spotters



A. RESOLVE® HIGH TRAFFIC™ CARPET CLEANING GRANULES RECKITT BENCKISER

Safe on wool, nylon, synthetic and stain-resistant carpets. Quickly and effectively clean the tough ground-in dirt from high-traffic areas. Formulated to "dry" clean without creating soggy, wet carpets. Attached brush uses standard broom handle for extension. Easy-to-use; just shake, brush and vacuum.

58347335 77335 1 gal. 4/cs.



B. RESOLVE® HIGH TRAFFIC™ FOAM CARPET CLEANER RECKITT BENCKISER

With Stain Repel™ protector that has a unique cleaning and protective formula to make carpet cleaning easier.

58340706 00706 22 oz. 12/cs.



C. RESOLVE® SPOT MAGIC® STAIN CLEANER RECKITT BENCKISER

Powerful, superior formula dissolves tough stains like greasy food, motor oil, red wine, grape juice, ink and coffee instantly without scrubbing.

58345892 75892 14 oz. 12/cs.



D. SIMPLE GREEN® CARPET CLEANER SIMPLE GREEN

Professional-strength formula deodorizes as it deep-cleans and safely removes tough stains such as: motor oil, grease, coffee, wine, chocolate, blood, lipstick, and much more. Non-toxic, non-allergenic, and biodegradable. Contains a special protection agent that helps maintain the stain resistance already found in most carpets, rugs and upholstery. Brightens without bleach, is clean rinsing and has no added color of petroleum distillates. Versatile, concentrated formula can be custom diluted to safely clean stains or for use in hot water extraction and steam carpet machines.

73437024 57024 22 oz. 12/cs.



E. SPOT SHOT® INSTANT CARPET STAIN REMOVER WD-40

Removes spots and stains instantly, without rubbing, scrubbing, or vacuuming. Specifically formulated with powerful cleaning agents, Spot Shot removes pet stains, cola, wine, urine, shoe polish, grease, ink, lipstick, blood, and thousands of other stains. Additionally, Spot Shot removes both oil-based and water-based stains, regardless of age, and won't leave any rings or residue.

51840998 998 18 oz. 12/cs.



F. BIOENZYMATIC CARPET SPOTTER ZEP

Environmentally preferred, biologically-based carpet spotter removes tough stains from carpets through combined detergent and enzymatic action.

75070014 R01001 1 qt. 12/cs.



G. BIOENZYMATIC DEODORIZING STAIN REMOVER ZEP

Biologically based deodorizing formulation uses enzymatic activity to eliminate stains and odor causing soils leaving a pleasant fresh fragrance. Use on carpets, bathroom floors or as a laundry prespotter. Excellent on odor causing pet stains.

75070012 R00801 1 qt. 12/cs.



H. HEAVY-DUTY CARPET SPOTTER ZEP

Water soluble solvent-based aerosol formulation removes oil and petroleum-based spots as well as water based soils and stains on carpet. Inverted spray can design for ease of use. Not suitable for stain resistant treated carpets.

75070013 R00901 24 oz. 12/cs.



I. PRE-MOISTENED UPHOLSTERY/CARPET SPOTTER TOWELS ZEP

Heavy-duty spotter towels designed to loosen and pick up soils of all types. Instantly remove stains from upholstery and carpet. Tough fabric construction will not tear or rip on carpet.

75070135 R09001 72 ct. 6/cs.



J. STAIN REMOVER W/PEROXIDE ZEP

Highly effective, easy-to-use carpet and upholstery stain remover formulated to remove difficult stains and odors without the use of damaging chemicals. Safe on stain resistant treated carpets. Simply spray and walk away.

75070011 R00701 1 qt. 6/cs.



Defoamers/Deodorizers



DEFOAMERS

A. PRIME SOURCE® DEFOAM DEFOAMER PRIME SOURCE®

Eliminates troublesome foam in the recovery system of carpet extractors. Saves labor and time. Economical to use.

75004088 75004088 1 gal. 4/cs.

B. BUBBLE BUSTER® DEFOAMER CARROLL

Quickly breaks down foam and prevents foam buildup. For use in all steam type carpet cleaning machines and wet-vacs. Use to greatly reduce time and labor needed to complete task. Highly concentrated, white opaque color; no fragrance added.

30010126 46028 1 gal. 4/cs.

DEODORIZERS

C. CARPET FRESH® NO-VACUUM CARPET REFRESHER WD-40

Just foam it on and odors are gone. The foam breaks up in minutes, leaving the carpet dry and trapped in odors are eliminated. And you don't have to vacuum. The fragrance is long lasting, leaving the entire room smelling fresh and clean.

51848030 28030 20 oz., Fresh 12/cs.

D. CARPET FRESH® POWDER RUG & ROOM DEODORIZER WD-40

Contains baking soda to help eliminate the odors trapped in carpets. Easy to use; just sprinkle it on and vacuum it up. The odors trapped in the carpet will be eliminated and your home will smell fresh and clean.

51840276 27600 20 oz., Country Potpourri 12/cs.

Standard Roll Toilet Tissue



STANDARD ROLL TOILET TISSUE

A. TOILET TISSUE PRIME SOURCE®

Green Source™

100% recycled. Chlorine-free. EcoLogo™ Certified. Trilingual packaging (English, Spanish, French).

75009500 75009500 2-Ply 96/cs.

Hi-Valu

Standard roll tissue is high quality and value priced. Ideal for all public environments.

73004353 73004353 1000 ct., 4 1/2" x 3 1/2", White, 1-Ply 96/cs.

73004354 73004354 500 ct., 4 1/2" x 3 1/2", White, 2-Ply 96/cs.

73004364 73004364 500 ct., 4 3/10" x 3 3/20", White, 2-Ply 96/cs.

73004365 73004365 500 ct., 4 1/2" x 3 1/10", White, 2-Ply 96/cs.

Universal

High quality, value priced tissue ideal for all public environments.

75004354 75004354 500 ct., 4 3/8" x 3 3/4", 2-Ply 96/cs.

75004360 75004360 500 ct., 4 1/2" x 3 1/5", 2-Ply 96/cs.

75004353 75004353 500 ct., 4 1/2" x 3 1/5", 2-Ply 48/cs.

75004355 75004355 500 ct., 4 3/8" x 4 1/2", 2-Ply 96/cs.

750043554 750043554 500 ct., 4 3/8" x 4 1/2", 2-Ply 96/cs.



B. TOILET TISSUE GEORGIA-PACIFIC

Angel Soft PS®

A recognized brand by 96% of consumers. High capacity roll decreases roll changes which reduces labor costs. Safe for all standard sewer and septic systems. Attractive embossing makes a positive impression with your customers. Clean upscale packaging coordinates with decor. Coordinates with facial tissue boxes for an elegant, professional look. Meets or exceeds EPA Comprehensive Procurement Guidelines for minimum post-consumer recycled fiber content.

13706580 16580 450 ct., 4 1/2" x 4", White, 2-Ply 80/cs.

13706640 16640 450 ct., 4 1/2" x 4", White, 2-Ply 40/cs.

Compact® Coreless

Coreless bath tissue rolls provides up to three times the sheet count of standard two-ply tissue. Fits Compact® high capacity tissue dispensers.

13709375 19375 1000 ct., 4" x 4 1/2", White, 2-Ply 36/cs.

13709378 19378 1500 ct., 4" x 4 1/2", White, 2-Ply 18/cs.

Envision®

Value-oriented multilayer bath tissue for environmentally concerned customers.

13709880 19880 550 ct., 4 1/2" x 4", White, 2-Ply 80/cs.

Preference®

EPA compliant for minimum post-consumer fiber content. Mid-range quality, embossed two-ply bathroom tissue.

13708280 1828001 550 ct., 4" x 4 1/20", White, 2-Ply 80/cs.

Quilted Nothern®

Premium quality, soft and absorbent embossed bath tissue.

13707060 17060 400 ct., 4 1/2" x 4", White, 2-Ply 60/cs.



C. TOILET TISSUE KIMBERLY-CLARK

Kleenex® Cottonelle®

Standard roll bathroom tissue offers the soft, plush quality of home. EZ to Handle package design with Zip-Off top allows for easy opening and storage.

15400315 54080 400 ct., 4" x 4", White, 2-Ply 48/cs.

15403136 03135 400 ct., 4 1/2" x 4", White, 2-Ply 20/cs.

15407713 07713 400 ct., 4 1/2" x 4 2/5", White, 2-Ply 96/cs.

15403137 13135 506 ct., 4 3/5" dia., 2-Ply 20/cs.

15407715 17713 506 ct., 4" x 4", White, 2-Ply 60/cs.

15408336 88336 506 ct., 4 1/2" x 4", White, 2-Ply 40/cs.

Kleenex® Cottonelle® Coreless

Bath tissue that delivers the soft, plush quality of home without the core.

15407001 07001 800 ct., 4" x 4 2/5", White, 2-Ply 36/cs.





Standard Roll Toilet Tissue

PAPER PRODUCTS



A. TOILET TISSUE

KIMBERLY-CLARK

Scott® 100% RF

Made with 100% recycled fiber. Meets EPA standards for 40% minimum post-consumer waste content. Green Seal® Certified.

15406446 64460 605 ct., 4 1/2" x 4", White, 2-Ply 80/cs.

Scott®

An excellent balance of strength, absorbency and economy. Meets EPA guidelines for post-consumer waste.

15405103 05102 1210 ct., 4 1/2" x 4", White, 1-Ply 80/cs.

15403607 03607 500 ct., 4 1/2" x 4 1/2", White, 2-Ply 24/cs.

15406050 0446050 605 ct., 4 1/2" x 4", White, 2-Ply 80/cs.

15401360 13607 605 ct., 4 1/10" x 4", White, 2-Ply 20/cs.

Scott® Coreless

Standard roll bath tissue is a high capacity, easy maintenance system which results in less run-outs and lower maintenance costs. Meets EPA guidelines for post-consumer waste - minimum of 45%. Elemental chlorine-free (ECF) bleaching. Waste reduction with 100% elimination of core waste. Nearly 75% longer than standard roll bath tissue - less roll changes. 5" roll diameter.

15404007 04007 1000 ct., 4" x 4 2/5", White, 2-Ply 36/cs.



B. TOILET TISSUE

MARCAL PAPER MILLS

Small Steps®

At home quality and coordinated packaging, perfect for any application. Individually wrapped rolls. 100% recycled. Whitened without chlorine bleaching. Hypoallergenic. Virtually lint free. No dye or fragrance.

15706024 6024 168 ct., 4 1/3" x 3 2/3", White, 2-Ply, Poly Bundle 24/cs.

15706466 16466 168 ct., 4 1/3" x 3 2/3", White, 2-Ply, Poly Bundle 96/cs.

15706080 6079 336 ct., 4 1/3" x 3 2/3", White, 2-Ply, Corr. Carton 48/cs.

15700003 6495 504 ct., 4 1/3" x 3 2/3", White, 2-Ply, Corr. Carton 48/cs.

Snow Lily®

Packaged in convenient polycase bundles that are not only strong, they are easier to handle, unload and store. 100% recycled. Whitened without chlorine bleaching. Hypoallergenic. Virtually lint free. No dye or fragrance.

15704072 4072 336 ct., 4 1/4" x 4 1/2", White, 2-Ply 48/cs.

Sunrise®

Packaged in convenient polycase bundles that are not only strong, they are easier to handle, unload and store. 100% recycled. Whitened without chlorine bleaching. Hypoallergenic. Virtually lint free. No dye or fragrance.

15703001 3001 240 ct., 4 1/3" x 3 2/5", White, 2-Ply 48/cs.



C. TOILET TISSUE

PROCTER & GAMBLE

Charmin® Basic Big Roll

A great balance of softness and strength. One Charmin® Basic Big Roll equals two regular rolls of Charmin® toilet tissue, so you save time and money. Unscented.

16900082 23458 308 ct., 4" x 4.27", 1-Ply 48/cs.

16900087 23464 308 ct., 4" x 4.27", 1-Ply 12/cs.

Charmin® Ultra

Squeezably soft. Unscented. Double roll. Safe for septic tanks.

16905987 84954189 400 ct., 4 1/2" x 4 1/5", White, 1-Ply 48/cs.

16906437 06437 200 ct., 4 1/2" x 4 2/5", White, 2-Ply 40/cs.

Charmin® Ultra Strong

What do you get when you combine Charmin softness with a DiamondWeave™ texture? A dependable clean for your whole family. Charmin Ultra Strong toilet paper is more durable than the ultra rippled brand, so you can count on a clean with fewer pieces left behind.

16900089 23992 4 Regular Rolls 96/cs.

16900151 29685 4 Big Rolls = 8 Regular Rolls, 176 ct. 40/cs.

16902372 12372 8 Giant Rolls = 20 Regular Rolls 40/cs.

16902367 12367 36 Giant Rolls = 90 Regular Rolls 96/cs.

Standard Roll Toilet Tissue



A. TORK® BATH TISSUE

SCA TISSUE

Tork® Advanced

High capacity rolls eliminate service outages. Embossed rolls enhance bulk and softness. The banded rolls create less waste and source reduction. Made from 100% recycled fibers, providing environmental benefits. Environmental Choice EcoLogo™ Certified.

14106121	TM6120S	500 ct., 4" x 3 ³ / ₄ " Sheets, 4 ⁷ / ₂₀ " Roll dia.	96/cs.
14106120	TM6120A	500 ct., 4 ¹ / ₅ " x 3 ³ / ₄ " Sheets, 4 ² / ₅ " Roll dia., Overall Wrapper	96/cs.
14101293	110292A	1000 ct., 3 ¹⁵ / ₁₆ " x 3 ³ / ₄ " Sheets, 5 ² / ₅ " Roll dia. Band Wrapper	36/cs.
14100086	110291A	2000 ct., 3 ¹⁵ / ₁₆ " x 3 ³ / ₄ " Sheets, 5 ² / ₅ " Roll dia.	36/cs.

Tork® Premium

An ultra soft, absorbent premium two-ply tissue service that delivers quality, value and performance. Each roll is overall wrapped and that ensures sanitary protection. The easy start tail seal prevents waste. Ideal for all plumbing systems.

14106511	TM6511S	460 ct., 4" x 3 ³ / ₅ " Sheets, 4 ² / ₅ " Roll dia.	96/cs.
----------	---------	---	--------

Tork® Universal

A soft, absorbent, economical tissue that delivers excellent combination of performance and value. Ideal for all plumbing systems. Made from 100% recycled fibers. EcoLogo™ Certified.

14101640	TS1639A	1000 ct., 4" x 3 ³ / ₄ " Sheets, 1-Ply	48/cs.
14101637	TS1636S	1000 ct., 4" x 3 ³ / ₄ " Sheets, 1-Ply	96/cs.
14101634	TS1636S	1000 ct., 4" x 3 ³ / ₄ " Sheets, 1-Ply	96/cs.
14101615	TM1616S	500 ct., 4" x 3 ³ / ₄ " Sheets, 2-Ply	96/cs.
14101616	TM1616	500 ct., 4 ¹ / ₅ " x 3 ³ / ₄ " Sheets, 2-Ply	96/cs.
14101604	TM1604	750 ct., 3 ⁹ / ₁₆ " x 3 ³ / ₄ " Sheets, 2-Ply	48/cs.



B. TOILET TISSUE

STEFECO

Confidence™

Offers the softness and quality of national branded products. Consistently bright, soft and absorbent. Ideal for hospitality venues, healthcare facilities and small businesses.

57370004	11500	500 ct., 4 ¹ / ₂ " x 4", 2-Ply	96/cs.
----------	-------	--	--------

Heavenly Soft™

A premium quality tissue that is ultra soft and absorbent with an attractive floral embossing. This premium bath tissue provides you comfort and strength in an attractive convenient package. Ideal for hospitality venues, healthcare facilities, and small businesses.

57371233	11233	1000 ct., 4 ¹ / ₁₀ " x 3 ¹ / ₂ ", Ind. Wrapped, 1-Ply	96/cs.
57370231	11231	1000 ct., 4 ¹ / ₂ " x 3 ³ / ₄ ", Ind. Wrapped, 1-Ply	96/cs.
57372230	12230	200 ct., 4 ¹ / ₁₀ " x 3 ¹ / ₂ ", 4 Roll Pack, 2-Ply	96/cs.
57371232	11232	500 ct., 4 ¹ / ₁₀ " x 3 ¹ / ₂ ", Ind. Wrapped, 2-Ply	96/cs.
57370230	11230	500 ct., 4 ¹ / ₂ " x 3 ³ / ₄ ", Ind. Wrapped, 2-Ply	96/cs.



C. TOILET TISSUE

WAUSAU PAPER/BAY WEST

Dubl-Nature® Green Seal®

Green Seal® Certified universal tissue features a floral embossing pattern. Made from a superior grade of 100% recycled wastepaper, Dubl-Nature® tissue contains up to 43% post-consumer wastepaper.

30030045	59890	500 ct., 4 ³ / ₈ " x 3 ³ / ₄ ", 2-Ply	80/cs.
----------	-------	---	--------

DublSoft®

Premium quality, softness and absorbency.

30036348	06348	500 ct., 4 ³ / ₈ " x 4", 2-Ply	48/cs.
30036380	06380	500 ct., 4 ³ / ₈ " x 4", 2-Ply	80/cs.
30036325	06325	625 ct., 3 ⁷ / ₈ " x 4", 2-Ply	48/cs.
30036390	06390	800 ct., 3 ³ / ₄ " x 4", 2-Ply	36/cs.

EcoSoft™ Green Seal® Universal

Green Seal® Certified toilet tissue that is 100% recycled and embossed for softness.

Contains up to 49% post-consumer waste which exceeds EPA guidelines.

30034900	54900	500 ct., 4 ³ / ₈ " x 3 ³ / ₄ ", 2-Ply	96/cs.
----------	-------	---	--------

EcoSoft™ Universal

EcoSoft™ single roll universal tissue is 100% recycled fibers. Contains 20% post-consumer recovered materials. Meets EPA guidelines for wastepaper content.

30030009	14000	1000 ct., 4 ³ / ₈ " x 3 ³ / ₄ ", 1-Ply	96/cs.
30030049	11500	1500 ct., 4 ³ / ₈ " x 4 ¹ / ₂ ", 1-Ply	60/cs.
30030001	54000	500 ct., 4 ³ / ₈ " x 3 ³ / ₄ ", 2-Ply	96/cs.



Jr./Mini & Jumbo Roll Toilet Tissue



JR./MINI JUMBO ROLLS TOILET TISSUE

A. JR. JUMBO ROLL TOILET TISSUE

KIMBERLY-CLARK

Kleenex® Cottonelle® JRT®

All the benefits of jumbo tissue with Kleenex® quality.

15403148 03148 3¹⁰/₁₁" x 1000', White, 2-Ply 4/cs.

15407305 07304 3⁷/₁₀" x 750', White, 2-Ply 12/cs.

Scott® 100% RF JRT®

Made with 100% recycled fiber. Meets EPA standards for 40% minimum post-consumer waste content. Green Seal® Certified.

15406722 67223 3⁵/₈" x 2000', White, 1-Ply, Green Seal® 12/cs.

15406780 67805 3⁵/₈" x 1000', White, 2-Ply, Green Seal® 12/cs.

Scott® JRT®

Ideal for high traffic areas. Meets EPA Standards for minimum post-consumer waste content.

15407224 07223 3¹/₂" x 2000', White, 1-Ply 12/cs.

15400373 07805 3¹/₂" x 1000', White, 2-Ply 12/cs.

Scott® JRT® Coreless

Brings together high capacity bathroom tissue and innovation. With this system there are no cores and no headaches. This product meets EPA guidelines for post-consumer waste with a minimum 45% post-consumer recycled waste. Elemental chlorine-free (ECF). Will reduce packaging waste by 45% when compared to cored JRT. Designed for the electronic coreless JRT dispenser but will work in all manual coreless dispensers as well.

15407007 07007 3⁷/₈" x 1000', White 12/cs.

15407006 07006 3⁷/₁₀" x 1150', White 12/cs.

15407005 07005 3⁷/₁₀" x 2300', White 12/cs.

Tradition® JRT®

Combines roll towel economy and softness, without compromising quality.

15402129 02129 3²⁵/₃₂" x 1000', White, 2-Ply 12/cs.

B. TORK® MINI JUMBO ROLL TOILET TISSUE

SCA TISSUE

Tork® Advanced

High capacity provides fewer refills and reduces labor. Reduced stub roll means less waste.

Fewer cores and no wrappers leads to source reduction. Less storage space is needed.

Made from 100% recycled fibers. EcoLogo™ Certified.

14104402 12024402 3⁵/₈" x 751', 1-Ply 12/cs.

14103902 12013902 3⁵/₈" x 1925', 1-Ply 12/cs.

Tork® Universal

Made from 100% recycled fibers with no added dyes or fragrances. Rapid break-up

capability is ideal for all plumbing systems. Universal core is designed to fit virtually all size

jumbo tissue dispensers. EcoLogo™ Certified. 8⁷/₈" Roll diameter.

14100924 TJ0922A 3⁵/₈" x 1000', 2-Ply 12/cs.



JUMBO ROLL TOILET TISSUE

C. JUMBO ROLL TOILET TISSUE

PRIME SOURCE®

Green Source™

100% recycled. Chlorine-free. EcoLogo™ Certified. Trilingual packaging (English, Spanish, French).

75009505 75009505 2-Ply 12/cs.

75009506 75009506 2-Ply 12/cs.

Hi-Valu

Jumbo tissue is high quality and value priced. Ideal for all public environments.

73004351 73004351 3⁵/₈" x 2000', White, 1-Ply 12/cs.

73004352 73004352 3⁵/₈" x 4000', White, 1-Ply 6/cs.

73004356 73004356 3¹/₈" x 700', White, 2-Ply 12/cs.

73004357 73004357 3⁵/₈" x 700', White, 2-Ply 12/cs.

73004358 73004358 3⁵/₈" x 1000', White, 2-Ply 12/cs.

73004359 73004359 3⁵/₈" x 2000', White, 2-Ply 6/cs.



Jumbo Roll Toilet Tissue



A. JUMBO ROLL TOILET TISSUE (CONT.)

PRIME SOURCE®

Jumbo Toilet Tissue

High quality, value priced tissue ideal for all public environments.

75004351	75004351	3 ⁷ / ₈ " x 2000', 1-Ply	12/cs.
75004352	75004352	3 ⁷ / ₈ " x 4000', 1-Ply	6/cs.
75004358	75004358	3 ⁷ / ₈ " x 1000', 2-Ply	12/cs.
750043583	75004358	3 ⁷ / ₈ " x 1000', 2-Ply	12/cs.
76004358	76004358	3 ⁷ / ₈ " x 1000', 2-Ply	12/cs.
75004359	75004359	3 ⁷ / ₈ " x 2000', 2-Ply	6/cs.
75004361	75004361	3 ⁷ / ₈ " x 1000', 2-Ply	12/cs.



B. ACCLAIM® JUMBO ROLL BATH TISSUE

GEORGIA-PACIFIC

Economical bathroom tissue in a long-lasting jumbo junior roll format now in better packing and efficient put up case size. 3¹/₈" core.

13703728	13728	3 ¹ / ₈ " x 1000', White, 2-Ply	8/cs.
----------	-------	---	-------



C. SCOTT® SURPASS®

JRT® JUMBO ROLL TOILET TISSUE

KIMBERLY-CLARK

Since each roll is the equivalent of more than ten standard rolls, you will save upkeep time without sacrificing quality.

15407202	07202	3 ¹ / ₈ " x 4000', White, 1-Ply	6/cs.
15400374	07827	3 ¹ / ₈ " x 2000', White, 2-Ply	6/cs.



D. TORK® JUMBO ROLL TOILET TISSUE

SCA TISSUE

Tork® Advanced

Tork® Advanced jumbo bath tissue's high capacity provides fewer refills and reduces labor. Large size is pilfer proof, hard to conceal. Can't use at home. Perforated. Made from 100% recycled fiber. Provides environmental benefits. A positive image builder. EcoLogo™ Certified.

14100055	1101042	3 ⁵ / ₈ " x 2247', 1-Ply	6/cs.
14100920	TJ0921A	3 ⁵ / ₈ " x 1000', 2-Ply	12/cs.
14101503	12021502	3 ⁵ / ₈ " x 1600', 2-Ply	6/cs.

Tork® Universal

Soft, absorbent jumbo tissue delivers quality, value and performance. Made from 100% recycled fibers with no added dyes or fragrances. Rapid break-up capability is ideal for all plumbing systems. Universal core is designed to fit virtually all size jumbo tissue dispensers. Environmental Choice EcoLogo™ Certified.

14100914	TJ0912A	3 ⁵ / ₈ " x 2000', 1-Ply	12/cs.
14101214	TJ1212A	3 ⁵ / ₈ " x 4000', 1-Ply	6/cs.
14101222	TJ1222A	3 ⁵ / ₈ " x 2000', 2-Ply	6/cs.



E. JUMBO ROLL TISSUE

STEFECO

Non-perforated, soft, and biodegradable. One roll provides the equivalent in length of more than ten standards rolls, helping reduce run-out and maintenance cost. Fits most jumbo dispensers. 9" roll diameter. 3¹/₈" core.

57371300	JT10002	1000', White, 2-Ply	12/cs.
----------	---------	---------------------	--------



F. ECOSOFT™ JUMBO TOILET TISSUE

WAUSAU PAPER/BAY WEST

EcoSoft™ Green Seal® Universal

Green Seal® Certified and contains up to 49% post-consumer wastepaper. Made with de-inking and bleaching processes. Free of chlorine and other harmful chemicals.

30031029	10029	3 ⁷ / ₈ " x 1000', 2-Ply	12/cs.
30032003	20029	3 ⁷ / ₈ " x 2000', 2-Ply	6/cs.

EcoSoft™ Universal

Large 3.32" core fits most jumbo dispensers. 100% recycled and contains a minimum of 20% post-consumer waste, which meets EPA guidelines.

30031002	10020	3 ⁷ / ₈ " x 1000', 2-Ply, 9" Roll dia.	12/cs.
30032002	20020	3 ⁷ / ₈ " x 2000', 2-Ply, 12" Roll dia.	6/cs.



PAPER PRODUCTS



Controlled & Folded Toilet Tissue/Tissue Dispensers

PAPER PRODUCTS



CONTROLLED USE TOILET TISSUE

A. CONTROLLED USE TOILET TISSUE			PRIME SOURCE®
High quality, value priced tissue ideal for all public environments.			
75004344	75004344	1232 ct., 3 ⁷ / ₈ " x 4", White, 1-Ply	48/cs.
75004343	75004343	616 ct., 3 ⁷ / ₈ " x 4", White, 2-Ply	48/cs.
75004346	75004346	865 ct., 3 ⁷ / ₈ " x 4", White, 2-Ply	36/cs.



B. ECOSOFT™ CONTROLLED-USE TOILET TISSUE WAUSAU PAPER/BAY WEST

EcoSoft™			
EcoSoft™ bath tissue is 100% recycled and contains a minimum of 20% post-consumer waste, which meets EPA guidelines.			
30030548	54800	500 ct., 4 ³ / ₈ " x 3 ³ / ₄ ", 2-Ply	48/cs.
30030616	61600	616 ct., 3 ³ / ₄ " x 4", 2-Ply	48/cs.
EcoSoft™ Green Seal®			
Green Seal® Certified and contains up to 49% post-consumer wastepaper. Made with de-inking and bleaching processes. Free of chlorine and other harmful chemicals.			
30031990	61990	865 ct., 3 ³ / ₄ " x 4", 2-Ply	36/cs.



FOLDED TOILET TISSUE

C. KLEENEX® HYGIENIC FOLDED TOILET TISSUE			KIMBERLY-CLARK
Hygienic toilet tissue combines softness with handsome packaging and easy maintenance. Fully enclosed tissue system reduces potential of product contamination.			
15400332	48280	250 ct., 4 ¹ / ₂ " x 8 ¹ / ₃ ", White	9000/cs.



STANDARD ROLL TOILET TISSUE DISPENSERS

D. OPTICORE TOILET TISSUE DISPENSERS			PRIME SOURCE®
Designed for high capacity applications and features a locking cover to prevent product pilferage and waste. When installed according to the ADA guidelines, this dispenser is ADA Title III compliant.			
75004357	75004357	2-Roll Capacity, Black Translucent	1/ea.
Fits three rolls of toilet tissue, reducing maintenance time and labor. See-through design lets you know when you need to re-stock. When one roll of tissue is used, simply turn the dial to advance to the next roll.			
75004356	75004356	3-Roll Capacity, Black Translucent	1/ea.



E. TOILET TISSUE DISPENSERS			PRIME SOURCE®
Tissue dispenser holds two rolls.			
750043401	75004340	Black Translucent	1/ea.
75004340	75004340	Black Translucent	105/cs.
Tissue dispenser holds four rolls.			
750043371	75004337	Black Translucent	1/ea.
75004337	75004337	Black Translucent	60/cs.



F. DUETT® TOILET TISSUE DISPENSER			SAN JAMAR
Standard bath tissue dispenser is the ideal companion to any towel dispenser. The Duett eliminates waste by protecting a visible fresh roll until the first roll is completely used. Accommodates standard bath tissue rolls (4 ¹ / ₂ " to 5 ¹ / ₂ ").			
62573500	R3500TBK	2 Roll Capacity, Black Pearl	6/cs.



G. SHORELINE DELUXE TOILET TISSUE HOLDER			CCP
Zinc die cast bright chrome finish. Concealed hinge button at end, tension spring controls tissue flow.			
276008151	815	Single Roll	1/ea.

Toilet Tissue Dispensers



A. SINGLE ROLL TOILET TISSUE HOLDER CCP

Classic roll tissue holder. Pilfer-proof locking device; brake spring action. Conforms to Federal Spec. WW-H-001911.

276009901 RT22 Single Roll, 2³/₄" x 6" x 4¹/₄", Chrome 1/ea.



B. TOILET TISSUE DISPENSER SAN JAMAR

Tension springs prevent free rolling of tissue. Anti-theft lock prevents tissue roll theft. 1¹/₂" core size.

62570040 R260XC Dual Roll, 2³/₄" x 12³/₈" x 4¹/₂" 12/cs.

JR./MINI JUMBO ROLL TOILET TISSUE DISPENSERS

C. IN-SIGHT® SERIES I KIMBERLY-CLARK

JRT JR. ESCORT® TISSUE DISPENSER

Jumbo roll tissue dispenser is curved and contemporary, creating the best impression for your restrooms. Designed for easier access to tissue. Replaceable lock with push button option. Spare parts attached to back wall. Smoke transparent design for easy maintenance.

15409507 09507 13⁷/₈" x 16" x 5³/₄", Smoke 1/ea.



D. TORK® JUMBO ROLL MINI TWIN DISPENSER SCA TISSUE

The Tork® Twin T-Box Mini Jumbo Tissue Dispenser's large capacity dispenses up to ten times the capacity of conventional dispensers and reduces maintenance costs. Innovative design complements any decor. Unique tear feature eliminates risk of cutting or scratching hands. Rolls are protected so there is less waste, improved hygiene and reduced pilferage. Durable PMMA polystyrene dispensers provide low maintenance and trouble free service.

14107570 247570 2 Roll Capacity, White 4/cs.



JUMBO ROLL TOILET TISSUE DISPENSERS

E. IN-SIGHT® KIMBERLY-CLARK

CORED JRT® COMBO UNIT DISPENSER

Combination JRT® dispenser can be used with (2) JRT® Junior rolls or (1) JRT® Senior roll and a stub roll. An easy to use mechanism adjusts to meet the customer's needs. Can be used with or without a key.

15400551 09551 Smoke/Gray 1/ea.



F. OCEANS™ SAN JAMAR

SOLOETTE JUMBO BATH TISSUE DISPENSER

Universal for all brands of jumbo bath tissue up to 10¹/₂". Maximizes paper capacity with minimal space. Designed to provide easy access to paper. Provides ease of use by allowing multi-directional tearing. Contemporary design does not provide a flat surface to place cigarettes, minimizing ugly burn marks. Core size 3¹/₄".

625727901 R2790TBK 14"H x 13"W x 6"D, Black Pearl 1/ea.



G. RENAISSANCE™ SAN JAMAR

TWIN JUMBO TOILET TISSUE DISPENSER

Twin 9" jumbo bath tissue dispenser is the most versatile jumbo bath tissue dispenser due to its slim and compact size. Slider prevents access to the spare roll until the first roll is completely empty. Universal and dispenses any brand or quality of jumbo bath tissue. Break-resistant plastic.

625740001 R4000TBK 12" x 19" x 5¹/₄", Black Pearl 1/ea.

62574000 R4000TBK 12" x 19" x 5¹/₄", Black Pearl 4/cs.



PAPER PRODUCTS

Toilet Tissue Dispensers/Facial Tissue



A. VERSATWIN® TOILET TISSUE DISPENSER SAN JAMAR

For all brands of standard and industrial size bath tissue up to 5 1/2" diameter. Provides uninterrupted flow of paper, eliminating stub roll waste and reducing maintenance costs. Contemporary design saves space, prevents theft, and encloses rolls for maximum hygiene. Break and chemical-resistant. Mounts in any position. Patent pending. Capacity is two rolls (5 1/2" diameter, 4 1/2" wide) with a 1 1/2" core size.

62573600 R3600TBK 8" x 12 7/10" x 5 3/4", Black Pearl 6/cs.



B. TORK® BATH TISSUE JUMBO ROLL DISPENSER SCA TISSUE

Holds two rolls. See-through front reduces maintenance, allows quick and easy service checks. Elegant appearance complements any decor. High impact flame retardant, chemical-resistant, rigid vinyl plastic provides years of low maintenance, trouble-free service. Large capacity dispenser goes longer between refills.

14101020 56T1 2 Roll Capacity, Smoke/Gray 1/ea.

FOLDED TOILET TISSUE DISPENSER

C. TOILET TISSUE DISPENSER CCP

Combination tissue cabinet. For single or double fold tissue see-through gauge.

276014011 401SD 7" x 4 1/2" x 3 3/16", White 1/ea.



FACIAL TISSUE

D. FACIAL TISSUE PRIME SOURCE®

Hi-Valu

Facial tissue is high quality and value priced. Ideal for all public environments.

73004400 73004400 100 ct., 7.87" x 7.87", 2-Ply 30/cs.

Prime Source®

High quality, value priced tissue ideal for all public environments.

75004342 75004342 100 ct., 8" x 8 1/2", White, 2-Ply 30/cs.



E. FACIAL TISSUE KIMBERLY-CLARK

Kleenex® Anti-Viral

Now you can give your customers, employees and visitors the same assurance they can get at home. Kleenex® Anti-Viral Facial Tissue is the only tissue on the market proven to kill 99.9% of cold and flu viruses. This innovative new product is ideal for office buildings, schools, restaurants and doctor/dental offices.

15408075 28075 75 ct., 8 2/5" x 8 1/5", White 27/cs.

Kleenex® Boutique®

Offers the ideal tissue performance combined with handsome packaging and easy maintenance. A Signal® feature alerts you when it's time to change the box.

15400010 21200 95 ct., 8 2/5" x 8 2/5", White, Floral Box, 2-Ply 12/cs.

15406910 21269 95 ct., 8 2/5" x 8 2/5", White, Floral Box, 2-Ply 3420/cs.

15407061 2127060 95 ct., 8 2/5" x 8 2/5", White, Deco Box, 2-Ply 3420/cs.

15407619 21271 95 ct., 8 2/5" x 8 2/5", White, Deco Box, 2-Ply 3420/cs.

Kleenex® Lotion Brand

With lotion, for extra comfort.

15401002 21002 65 ct., 8 2/5" x 8 2/5", White 36/cs.

15406081 26080 80 ct., 8 2/5" x 8 2/5", White 27/cs.

Kleenex®

Delivers premium quality with outstanding value. The Signal® feature alerts you when it is time to change the box.

15407610 21195 65 ct., 8 2/5" x 5 1/5", Junior, White 3120/cs.

15405152 25152 45 ct., 8 2/5" x 8 2/5", White 1080/cs.

154014145 21414 10/100 ct., 8 2/5" x 8 2/5", White 10/cs.

15403036 21005 100 ct., 8 2/5" x 8 2/5", White 3000/cs.

15407606 21400 100 ct., 8 2/5" x 8 2/5", White 3600/cs.

15407621 0307620 125 ct., 8 2/5" x 8 2/5", White 12/cs.

15400371 21606 125 ct., 8 2/5" x 8 2/5", White 6000/cs.



Facial Tissue



A. FACIAL TISSUE (CONT.)

KIMBERLY-CLARK

Kleenex® Pocket Packet

These Kleenex® facial tissues have softness, strength and absorbency for your everyday needs. Pack a Kleenex® Pocket Packet wherever you go.

15400270	30140	15 ct., White, 2-Ply	1440/cs.
15403021	30210	15 ct., White, 2-Ply	2880/cs.

Scott® 100% RF Surpass Boutique

Made with 100% recycled fiber. Meets EPA standards for 40% minimum post-consumer waste content. Green Seal® Certified.

15401295	21295	110 ct., 8" x 8 ⁹ / ₁₀ ", White, 2-Ply	3960/cs.
----------	-------	--	----------

Scott® 100% RF Surpass Flat

Made with 100% recycled fiber. Meets EPA standards for 40% minimum post-consumer waste content. Green Seal® Certified.

15401285	21285	125 ct., 8" x 8 ⁹ / ₁₀ ", White, 2-Ply	60/125/cs.
----------	-------	--	------------

Scott® Surpass®

Features 50% more tissues per box than standard tissue boxes. The Signal® feature alerts you when it's time to change the box. Meets EPA guidelines for post-consumer waste.

15400038	03131	100 ct., 8" x 8 ¹ / ₂ ", White	1200/cs.
----------	-------	--	----------

Surpass® Boutique

Features 50% more tissues per box than standard tissue boxes. The Signal® feature alerts you when it's time to change the box. Meets EPA guidelines for post-consumer waste.

15401342	21320	100 ct., 8" x 8 ¹ / ₃ ", White, Cube Box	3960/cs.
----------	-------	--	----------

15401340	21340	100 ct., 8" x 8 ¹ / ₃ ", White, Flat Box	30/cs.
----------	-------	--	--------

15401390	21390	125 ct., 8" x 8 ² / ₅ ", White, Flat Box	60/cs.
----------	-------	--	--------

15405851	21380	150 ct., 8" x 8 ¹ / ₃ ", White, Flat Box	96/cs.
----------	-------	--	--------



B. FACIAL TISSUE

MARCAL PAPER MILLS

Fluff Out®

Tissues are interlocked to ensure one-at-a-time dispensing. Soft and absorbent without the use of lotions or fragrances. 100% recycled. Whitened without chlorine bleaching. Hypoallergenic. Virtually lint free. No dye or fragrance.

15702930	2930	100 ct., 8 ¹ / ₂ " x 7 ¹ / ₂ ", White, Flat Box	3000/cs.
----------	------	---	----------

Small Steps®

Whitened without chlorine bleaching. Hypoallergenic. Virtually lint free. No dye or fragrance. 100% recycled.

15704034	4034	80 ct., 9" x 8 ² / ₅ ", White, Bundle, 2-Ply	36/cs.
----------	------	--	--------

15704036	4036	80 ct., 9" x 8 ² / ₅ ", White, Cube, 2-Ply	36/cs.
----------	------	--	--------



C. PUFFS® FACIAL TISSUE

PROCTER & GAMBLE

Quality softness you can trust. Strong and absorbent tissues.

16906359	33549	216 ct., White, Rectangular Carton, 2-Ply	24/cs.
----------	-------	---	--------



D. TORK® ADVANCED FACIAL TISSUE

SCA TISSUE

Tork® Advanced

Extra soft and absorbent facial tissue offers the right combination of performance and value. Soft shield protects the tissues and provides easy, one-at-a-time dispensing. The flat box style is ideal for the vanity or in-wall dispensers. Made from 100% recycled fibers, helps conserve natural resources. Dispenser box is manufactured from 100% recycled materials with a minimum of 15% post-consumer materials.

14106811	TF6810	100 ct., 2-Ply, Flat Box	30/cs.
----------	--------	--------------------------	--------

Tork® Premium

Ultra soft, premium tissue tells users you care about their comfort. A different color indicator sheet shows when the tissue box is nearly empty. Soft shield protects the tissues and provides easy, one-at-a-time dispensing. Cube box style is ideal for the vanity or in-wall dispensers. Dispenser box is manufactured from 100% recycled materials with a minimum of 35% post-consumer materials.

14106910	TF6910	94 ct., 2-Ply, Cube Box	36/cs.
----------	--------	-------------------------	--------

Tork® Universal

Soft and absorbent facial tissue offers the right combination of performance and value. The flat box style is ideal for the vanity or in-wall dispensers. Made from 100% recycled fibers, helps conserve natural resources. Dispenser box is manufactured from 100% recycled materials with a minimum of 15% post-consumer materials.

14106710	TF6710A	100 ct., 2-Ply, Flat Box	3000/cs.
----------	---------	--------------------------	----------



PAPER PRODUCTS



Facial Tissue/Roll Towels



A. FACIAL TISSUE WAUSAU PAPER/BAY WEST

DublSoft®
Premium facial tissue provides the most discriminating customer with softness, strength and absorbency.

30036185	<i>DS6185</i>	85 ct., 9" x 8", 2-Ply, Cube Box	36/cs.
30036100	<i>DS6100</i>	100 ct., 9" x 8", 2-Ply, Flat Box	3000/cs.

EcoSoft™ Green Seal®
Facial tissue that is Green Seal® Certified. Made from 100% recycled fibers and meets EPA guidelines with 10% post-consumer waste.

30034901	<i>15000</i>	150 ct., 8 ³ / ₄ " x 8", 2-Ply	30/cs.
-----------------	--------------	--	--------

ROLL TOWELS

B. ROLL TOWELS PRIME SOURCE®

Green Source™
100% recycled. Chlorine-free. EcoLogo™ Certified. Trilingual packaging (English, Spanish, French).

75009525	<i>75009525</i>	7 ³ / ₄ " x 300', Natural, Standard	12/cs.
75009520	<i>75009520</i>	7 ³ / ₄ " x 300', White, Standard	12/cs.
75009535	<i>75009535</i>	7 ³ / ₄ " x 700', Natural, Jumbo	6/cs.
75009530	<i>75009530</i>	7 ³ / ₄ " x 700', White, Jumbo	6/cs.

Hardwound Roll Towels
High quality, value priced paper towel ideal for all public environments.

75004322	<i>75004322</i>	8" x 350', Natural	12/cs.
75004324	<i>75004322</i>	8" x 350', Natural	12/cs.
75004321	<i>75004321</i>	8" x 350', White	12/cs.
750043214	<i>75004321</i>	8" x 350', White	12/cs.
75004334	<i>75004334</i>	8" x 450', White	12/cs.
75004315	<i>75004315</i>	8" x 630', Leaf Embossed	6/cs.
75004332	<i>75004332</i>	8" x 800', Natural	6/cs.
75004324	<i>75004324</i>	8" x 800', Natural	6/cs.
750043244	<i>75004324</i>	8" x 800', Natural	6/cs.
75004333	<i>75004333</i>	8" x 800', White	6/cs.
75004323	<i>75004323</i>	8" x 800', White	6/cs.
75004326	<i>75004326</i>	11" x 157 ¹ / ₂ ', 210 ct., White	12/cs.

Hi-Valu
Universal roll towels that are high quality and value priced. Ideal for all public environments.

73004322	<i>73004322</i>	7 ³ / ₄ " x 350', Natural	12/cs.
73004329	<i>73004329</i>	7 ³ / ₄ " x 350', Natural	12/cs.
73004321	<i>73004321</i>	7 ³ / ₄ " x 350', White	12/cs.
73004328	<i>73004328</i>	7 ³ / ₄ " x 350', White	12/cs.
73004334	<i>73004334</i>	7 ³ / ₄ " x 600', Natural	96/cs.
73004339	<i>73004339</i>	7 ³ / ₄ " x 600', Natural	12/cs.
73004333	<i>73004333</i>	7 ³ / ₄ " x 600', White	12/cs.
73004338	<i>73004338</i>	7 ³ / ₄ " x 600', White	12/cs.
73004324	<i>73004324</i>	7 ³ / ₄ " x 800', Natural	6/cs.
73004323	<i>73004323</i>	7 ³ / ₄ " x 800', White	6/cs.

C. HARDWOUND ROLL TOWELS GEORGIA-PACIFIC

Enmotion®
High capacity, high quality roll towels for wall-mount enMotion automated, touchless, electronic roll towel system.

13709461	<i>89460</i>	10" x 800', White, 1-Ply	6/cs.
-----------------	--------------	--------------------------	-------

Envision®
Economy hardwound roll towels. EPA compliant for environmentally concerned customers. Delivers reliable performance at a low cost. 1⁵/₈" core.

13706301	<i>26301</i>	7 ⁷ / ₈ " x 800', Brown, 1-Ply	6/cs.
-----------------	--------------	--	-------



PAPER PRODUCTS

Roll Towels



A. HARD ROLL TOWELS

KIMBERLY-CLARK

Hardwound

Hardwound roll towels.

15403051 0305100 400', White 8/cs.

Kleenex®

Kleenex® hard roll towels have absorbency pockets that absorb lots of water fast for superior hand drying. Soft premium towel with embossed pattern. Meet EPA standards with a minimum of 40% post-consumer waste.

15401080 01080 8" x 425', White, 1-Ply, 1½" Core 12/cs.

15401091 11090 8" x 600', White, Zip-Off Pack, 1½" Core 6/cs.

15400606 50606 8" x 600', White, Zip-Off Pack, 1¾" Core 6/cs.

15405060 50606 8" x 600', White, Zip-Off Pack, 1¾" Core 12/cs.

Scott® 100% RF

Made with 100% recycled fiber. Meets EPA standards for 40% minimum post-consumer waste content. Green Seal® Certified.

15402031 02031 8" x 800', Natural, 1-Ply, Green Seal® 12/cs.

15401052 01052 8" x 800', White, 1-Ply, Green Seal® 12/cs.

Scott®

Hydroflex Compression adds 25% more towels without increasing roll diameter or sacrificing performance.

15400376 01000 8" x 1000', 1-Ply 12/cs.

15401005 01005 8" x 1000', 1-Ply 6/cs.

Scott® roll towels provide reliable quality, softness, and absorbency.

15402068 02068 8" x 400', White, 1-Ply 12/cs.

15400375 01040 8" x 800', White, 1-Ply 12/cs.

Made of 40% post-consumer waste content; elemental chlorine-free (EFC) bleaching; packaging reduction through providing greater feet per case and 19% more towels on each core (compared to 800' roll towels).

15402000 02000 8" x 950', White, 1-Ply 6/cs.

100% recovered materials; have a minimum of 60% post-consumer recycled waste; elemental chlorine-free (ECF) bleaching; and are made from recycled cardboard.

15400046 02021 8" x 400', Natural, 1-Ply 12/cs.

15404150 04142 8" x 800', Natural, 1-Ply 12/cs.

Tradition®

Maximum utility and value in these soft yet strong, hard-working paper towels that are designed to tackle tough jobs.

15404128 04128 8" x 350', Brown, 1-Ply 12/cs.

B. TORK® ROLL TOWELS

SCA TISSUE

Tork® Advanced

Designed specifically for the Tork Matic® and Tork Intuition® roll towel dispensers, this Tork Advanced towel offers a truly best-in-class product for no touch, hygienic dispensing systems. Embossing enhances hand feel and maximum absorbency; fewer towels are used per hand dry. Less packaging means source reduction reducing your overall labor and maintenance costs. Made from 100% recycled fiber. EcoLogo™ Certified.

14100485 290092 7¼" x 525', White 6/cs.

14100489 290089 7¾" x 700', White 6/cs.

14101350 RB350A 7⅞" x 350', White 12/cs.

14100600 RB600 7⅞" x 600', White 12/cs.

14100800 RB800 7⅞" x 800', White 6/cs.

Tork® Universal

Embossing enhances hand feel and maximizes absorbency, fewer towels used per hand dry. Roll towel performance provides source reduction and less packaging. Long lasting rolls minimize maintenance costs while maximizing service. Made from 100% recycled fiber. EcoLogo™ Certified.

14100488 290088 7¾" x 700', Natural (For Matic Dispenser) 6/cs.

14100050 RB425 7¾" x 425', White, Green Seal® 12/cs.

14100104 RK206E 7⅞" x 206', Natural 24/cs.

14101351 RK350A 7⅞" x 350', Natural 12/cs.

14100351 RB351 7⅞" x 350', White 12/cs.

14106000 RK600E 7⅞" x 600', Natural 12/cs.

14106002 RB6002 7⅞" x 600', White 12/cs.

14100103 RK800E 7⅞" x 800', Natural 6/cs.



Roll Towels/Controlled Roll Towels



A. ROLL TOWELS

STEFECO

Confidence™

Made with TAD (Thru-Air-Drying Technology), providing more absorbency, extra softness and strength. Premium quality towels for upscale washrooms. Optimum hand drying performance over standard hardwound roll towels.

57372501 42501 10" x 600' 4/cs.

Hardwound

The non-perforated one-ply roll towel is designed primarily for hand drying but they can also be use for any cleaning purposes. High quality, with maximum absorbency. Designed to work with any universal roll towel dispenser. 2" core.

57371304 HW350N 350', Natural, 1-Ply 12/cs.

Heavenly Soft™

Made from 100% recycled paper. Non-perforated, strong, and absorbent. Provide effective hand drying with less paper waste. Fits most crank, lever, and hands-free roll towel dispensers.

57374123 41230 350', Natural, 1-Ply 12/cs.

57370232 41232 600', Natural, 1-Ply 12/cs.

57371239 41233 600', White, 1-Ply 12/cs.

57371236 41236 800', Natural, 1-Ply 6/cs.

57371237 41235 800', White, 1-Ply 6/cs.



B. ROLL TOWELS

WAUSAU PAPER/BAY WEST

Dubl-Nature® Green Seal®

Green Seal® Certified embossed roll towels that are 100% recycled and contain up to 49% post-consumer waste content. Featuring a consumer-like "leaf" embossing pattern.

30030038 38090 8" x 800', White 6/cs.

EcoSoft™ Green Seal®

Roll towels with a 1 1/2" core can be dispensed through universal roll towel dispensers.

EcoSoft™ Green Seal® roll towels are 100% recycled and made entirely from recovered fibers. Natural towels contain up to 82% post-consumer waste. Natural white towels contain up to 73% post-consumer waste.

30030463 46300 8" x 425', Natural White 12/cs.

30030458 45800 8" x 800', Natural 6/cs.

30030459 45900 8" x 800', Natural White 6/cs.

EcoSoft™ Universal

EcoSoft™ roll towels are made of 100% recycled paper and contain a minimum 40% post-consumer waste, which meets EPA guidelines.

30030015 46200 8" x 350', Natural 12/cs.

30030016 46000 8" x 425', Natural 12/cs.

30030013 46500 8" x 425', White 12/cs.

CONTROLLED ROLL TOWELS



C. CONTROLLED ROLL TOWELS

WAUSAU PAPER/BAY WEST

DublSoft®

These controlled roll towels offer high-capacity benefits combined with a premium appearance. Features an exclusive "leaf" embossing design for superior softness, strength and absorbency. Controlled usage for value added cost savings when combined with controlled roll towel dispensing systems.

30036308 06308 8" x 630', White 6/cs.

EcoSoft®

Made of 100% recycled paper and contain a minimum 40% post-consumer waste, which meets EPA guidelines.

30031600 71600 7 1/2" x 630', White 6/cs.

30030713 71300 7 1/2" x 800', Natural 6/cs.

30030097 71400 7 1/2" x 800', Natural White 6/cs.

30030044 20300 8" x 425', White 12/cs.

30033156 31500 8" x 630', Natural 6/cs.

30033160 31600 8" x 630', White 6/cs.

30030313 31300 8" x 800', Natural 6/cs.

30030117 31400 8" x 800', Natural White 6/cs.

30030319 31900 8" x 800', White 6/cs.

Centerpull Towels



CENTERPULL TOWELS

A. CENTERPULL TOWELS

GEORGIA-PACIFIC

Preference®

Refill centerpull towels for the smart Preference® hands-free dispensing system.

13704000 44000 520 ct., 8¹/₂" x 12", White, 2-Ply 6/cs.

Sofpull®

Premium, one-at-a-time dispensing, centerpull towels. Each sheet dispenses fully open and ready-to-use, delivering the right amount of toweling to handle any size clean-up quickly and easily. 2³/₈" core.

13708124 28124 320 ct., 7¹/₂" x 15", White, 1-Ply 6/cs.

13708143 28143 560 ct., 7¹/₂" x 15", White, 1-Ply 4/cs.



B. CENTERPULL TOWELS

KIMBERLY-CLARK

Kleenex® Premiere®

For simple one-handed use. Exclusive absorbency pockets.

15401076 01076 250 ct., 15" x 8", White, 1-Ply 6/cs.

15401320 01320 250 ct., 15" x 8", White, 1-Ply 4/250/cs.

Scott®

These towels dispense from the center of the roll, for simple one-handed use.

15401051 01051 500 ct., 8" x 15", White, 1-Ply 2000/cs.

15401020 01020 250 ct., 8" x 15", White, 2-Ply 1500/cs.

15400345 01010 500 ct., 8" x 15", White, 2-Ply 2000/cs.

Scott® Roll Control

A center-flow system that reduces dispensing problems.

15403054 01032 750', 8" x 12", White 6/cs.



C. TORK® CENTERPULL TOWELS

SCA TISSUE

Tork® Advanced Mini

High capacity, reduces labor and refills. High absorbency, means less towels used. Touch only dispensing towel reduces cross contamination. Made from 100% recycled fiber provides environmental benefits, and a positive image builder. EcoLogo™ Certified.

14100385 121225 262', 8³/₁₀" x 11¹/₅", 2-Ply 12/cs.

14101225 121225 262', 8³/₁₀" x 11¹/₅", 2-Ply 12/cs.

Tork® Universal

Offer one-at-a-time service and reduced waste. High capacity reduces labor and refills. High absorbency means less towels used. Made from 100% recycled fiber, providing environmental benefits. EcoLogo™ Certified. 2⁹/₁₀" core diameters.

14100133 120133 1000 ct., 983', 7¹/₅" Roll dia., White, 1-Ply 6/cs.

14101932 120932 500 ct., 491', 7¹/₁₀" Roll dia., White, 2-Ply 6/cs.

14100105 121211 600 ct., 590', 7¹/₅" Roll dia., White, 2-Ply 6/cs.

14101230 121201 600 ct., 590', 7¹/₅" Roll dia., White, 2-Ply 6/cs.

14100134 121202 610 ct., 600', 7¹/₅" Roll dia., White, 2-Ply 6/cs.



D. CENTERPULL TOWELS

STEFECO

This perforated center pull towel is absorbent, strong, convenient and hygienic.

57371309 CP6002 8" x 600', White, 2-Ply 6/cs.

Heavenly Soft™

Absorbent, strong, convenient, and hygienic. Cost effective towels are perforated to ensure one-at-a time dispensing.

57370235 31235 1000 ct., 8", 1-Ply 6/cs.

57371235 31230 265 ct., 8", 2-Ply 12/cs.

57370233 31233 600 ct., 8", 2-Ply 6/cs.

573702339 31233 600 ct., 8", 2-Ply 330/cs.

57370234 31234 660 ct., 8", 2-Ply 6/cs.



E. ECOSOFT™

CENTERPULL ROLL TOWELS

WAUSAU PAPER/BAY WEST

Made from high quality 100% recycled paper fiber. Features extra embossing for maximum softness and absorbency.

30036002 06002 7³/₄" x 600', White, 2-Ply 6/cs.





Kitchen Roll Towels



KITCHEN ROLL TOWELS

A. KITCHEN ROLL TOWELS PRIME SOURCE®

Green Source™
100% recycled. Chlorine-free. EcoLogo™ Certified. Trilingual packaging (English, Spanish, French).

75009555	75009555	11", 210 ct., White, 2-Ply	12/cs.
-----------------	----------	----------------------------	--------

Kitchen Roll Towels
High quality, value priced paper towel ideal for all public environments.

75004328	75004328	70 ct., 11" x 9", White, 2-Ply	30/cs.
75004327	75004327	80 ct., 11" x 9", White, 2-Ply	30/cs.
75004324	75004327	80 ct., 11" x 9", White, 2-Ply	30/cs.



B. KITCHEN ROLL TOWELS GEORGIA-PACIFIC

Preference®
Popular perforated roll towels offer reliable performance for everyday cleaning and wiping tasks.

13700225	27385	85 ct., 11" x 8 ¹ / ₂ ", White, 2-Ply	30/cs.
13707678	27300	100 ct., 11" x 8 ¹ / ₂ ", White, 2-Ply	30/cs.

Sparkle PS®
These towels bring the premium quality and brand recognition of our retail Sparkle® perforated roll towels to the commercial marketplace. Pick-A-Size® sheets provide the right size towel for any size cleaning challenge.

13707112	27112	232 ct., 11" x 5 ¹ / ₂ ", White, 2-Ply	12/cs.
-----------------	-------	--	--------

C. KITCHEN ROLL TOWELS KIMBERLY-CLARK

Kleenex® Premiere® Perforated
Cloth-like perforated towels are strong enough for wet scrubbing and soft enough for hand drying. Highly absorbent towels are made with Hydroknit® technology so they are woven strong.

15408125	88125	55 ct., 10 ³ / ₈ " x 11", White	24/cs.
-----------------	-------	---	--------

Preferred towel for softness, hand-drying and wiping power. Strong, absorbent towels with a soft feel.

15403405	03405	90 ct., 10 ³ / ₈ " x 11", White	20/cs.
15403643	03405	90 ct., 10 ³ / ₈ " x 11", White	12/cs.

Scott®
Soft and absorbent for excellent performance.

15400002	01482	90 ct., 11" x 9 ³ / ₈ ", White	30/cs.
15400136	13608	96 ct., 11" x 8 ³ / ₈ ", White	15/cs.
15401482	41482	128 ct., 11" x 8 ³ / ₄ ", White	20/cs.
15403609	39109	180 ct., 11" x 9 ³ / ₈ ", White	15/cs.



D. KITCHEN ROLL TOWELS MARCAL PAPER MILLS

Small Steps®
100% recycled. Whitened without chlorine bleaching. Hypoallergenic. Virtually lint free. No dye or fragrance.

15706711	6709	60 ct., 11" x 9", White, Carton, 2-Ply	15/cs.
-----------------	------	--	--------

Small Steps® Giant Size
Perforated roll towel. 100% recycled. Whitened without chlorine bleaching. Hypoallergenic. Virtually lint free. No dye or fragrance.

15706181	6181	140 ct., 11" x 5 ⁷ / ₁₀ ", White, Carton, 2-Ply	24/cs.
15700005	6183	150 ct., 11" x 5 ⁷ / ₁₀ " White, 2-Ply	12/cs.

Sunrise®
Quilted embossing adds to its quick and thorough absorbing power. Sunrise® roll towels are free from any inks making these towels perfect for any clean-up job. 100% recycled. Whitened without chlorine bleaching. Hypoallergenic. Virtually lint free. No dye or fragrance.

15700630	630	60 ct., 11" x 9", White, Carton, 2-Ply	30/cs.
15700610	610	60 ct., 11" x 9", White, Poly Bundle, 2-Ply	15/cs.



PAPER PRODUCTS

Kitchen Roll Towels/C-Fold Towels



A. KITCHEN ROLL TOWELS PROCTER & GAMBLE

Bounty®

Perforated roll paper towels are strong and quick absorbing even when wet.

16900064	21196	52 ct., 11" x 11", White, 2-Ply	30/cs.
16908838	28838	52 ct., 11" x 11", White, Regular, 2-Ply	30/cs.
16900595	10595	56 ct., 11" x 11", White, 2-Ply	30/cs.
16905286	40752	60 ct., 11" x 11", White, 2-Ply	15/cs.
16900065	20875	70 ct., White, Cooking	24/cs.

Bounty® Basic

Strong and absorbent, and a great value too. Has a honeycomb texture for strength. Just right for all your everyday paper towel jobs.

16900135	28322	52 ct., 11" x 11", White, 1-Ply	12/cs.
----------	-------	---------------------------------	--------

B. TORK® KITCHEN ROLL TOWELS SCA TISSUE

Tork® Advanced

High-bulk construction that maximizes absorbency for superior spill holding power using fewer towels. Super strong soft towels hold together even on tough jobs. Ideal for cleaning and wiping all surfaces. Made from 100% recycled fibers has environmental benefits and is a positive image builder. EcoLogo™ Certified

14100107	HB9201	120 ct., 11"W x 6 ³ / ₄ "L, White, 2-Ply	30/cs.
----------	--------	--	--------

Tork® Universal

High-bulk construction that maximizes absorbency for superior spill holding power using fewer towels. Super strong soft towels hold together even on tough jobs. Ideal for cleaning and wiping all surfaces. Made from 100% recycled fiber provides environmental benefits, and a positive image builder. EcoLogo™ Certified.

14100122	HB1990A	84 ct., 9" x 11", White, 2-Ply	30/cs.
14101975	HK1975A	210 ct., 9" x 11", Natural, 2-Ply	12/cs.
14101996	HB1995A	210 ct., 9" x 11", White, 2-Ply	12/cs.

C. HEAVENLY SOFT™ KITCHEN ROLL TOWELS STEFCO

Made from natural fibers, these kitchen roll towels have a proprietary embossing pattern. Soft, strong, and absorbent. Very reliable. For every day cleaning and wiping tasks. Individually wrapped.

57379180	52231	85 ct., 11" x 8 ¹ / ₂ ", White, 2-Ply	30/cs.
----------	-------	---	--------

D. KITCHEN ROLL TOWELS WAUSAU PAPER/BAY WEST

EcoSoft™

Household toweling that is 100% recycled and contains a minimum of 40% post-consumer waste, which meets EPA guidelines. This household toweling is heavily embossed for maximum absorbency and performance, with the wet strength needed for use in business and industry.

30030110	41000	90 ct., 11" x 9", 2-Ply	30/cs.
30030002	40000	100 ct., 11" x 9", 2-Ply	30/cs.

EcoSoft™ Green Seal®

Roll towels that are heavily embossed for superior absorbency and performance. This toweling has the wet strength needed for use in business and industry. EcoSoft™ Green Seal® household toweling is certified as environmentally preferable by Green Seal, Inc.

30031090	41090	90 ct., 11" x 9", 2-Ply	30/cs.
----------	-------	-------------------------	--------

C-FOLD TOWELS

E. C-FOLD TOWELS PRIME SOURCE®

C-Fold Towels

High quality, value priced. Ideal for all public environments.

75004312	75004312	150 ct., 10 ¹ / ₄ " x 13", Natural	2400/cs.
75004304	75004304	150 ct., 10 ¹ / ₄ " x 13", White	2400/cs.
750043044	75004304	150 ct., 10 ¹ / ₄ " x 13", White	2400/cs.

Hi-Valu

High quality and value priced. Ideal for all public environments.

73004304	73004304	150 ct., 10 ¹ / ₄ " x 13"	2400/cs.
----------	----------	---	----------





C-Fold Towels

PAPER PRODUCTS



A. C-FOLD TOWELS

GEORGIA-PACIFIC

Acclaim®

Economy C-fold towels for reliable performance at a low cost. Designed to fit into a wide range of appropriate dispensers. Folded Width: 3 1/4".

13707622 20603 240 ct., 10 1/4" x 13 1/4", White 2400/cs.

Signature®

These premium C-fold towels feature a patented honeycomb emboss that adds a touch of elegance to any washroom, while two thick and thirsty plies offer super absorbency with every hand dry. Folded width: 3 5/8".

13700176 23000 120 ct., 10 1/4" x 13 1/4", White, 2-Ply 1440/cs.



B. C-FOLD TOWELS

KIMBERLY-CLARK

Kleenex®

Dependable, folded towels that you can look to for softness, absorbency and performance. FSC Certified.

15401500 01500 150 ct., 10 1/8" x 13 1/8", White 2400/cs.

15400059 01500 150 ct., 10 1/8" x 13 1/8", White 2400/cs.

Scott® 100% RF

Made with 100% recycled fiber. Meets EPA standards for 40% minimum post-consumer waste content. Green Seal® Certified.

15402921 02920 200 ct., 10 1/10" x 13 1/5", White, 1-Ply 2400/cs.

Scott®

Depend on these for reliable performance. Fits dispensers 09008, 09009, 09905, 09906, 09952 and 09976.

15401510 01510 150 ct., 10 1/8" x 13 1/8", White, 1-Ply 2400/cs.

Scott® Select®

C-fold towels.

15403623 03623 150 ct., 13 1/5" x 10 2/5", White 1800/cs.

Tradition™

This paper towel is suitable for most anywhere and are among our most popular choice in folded towels.

15404140 0292050 13" x 10 1/4", White, 1-Ply 2400/cs.



C. TORK® C-FOLD TOWELS

SCA TISSUE

Tork® Advanced

Soft and absorbent towels. Embossing enhances hand feel and maximizes absorbency. High wet strength. Improved product design helps to control usage. Made from 100% recycled fiber. EcoLogo™ Certified. 100% recycled chipboard sleeves assure maximum protection and ease of handling. 3 13/20" x 10 1/8" folded.

14100700 CB520 150 ct., 12 3/4" x 10 1/8", White 2400/cs.

Tork® Premium

Soft and absorbent C-fold towels offer the perfect combination of quality, performance and value. High wet strength designed to please your most demanding users. Improved product design helps to control usage, so you save on reduced waste and maintenance time.

Replaces CB540A. 3 13/20" x 10 1/8" folded.

14101540 CB510 125 ct., 12 3/4" x 10 1/8", White 2400/cs.

Tork® Universal

Soft and absorbent towels. Embossing enhances hand feel and maximizes absorbency. High wet strength. Improved product design helps to control usage. Made from 100% recycled fiber. EcoLogo™ Certified. 100% recycled chipboard sleeves assure maximum protection and ease of handling. 3 13/20" x 10 1/8" folded.

14100706 CB530 150 ct., 12 3/4" x 10 1/8", White 2400/cs.



D. C-FOLD TOWELS

WAUSAU PAPER/BAY WEST

EcoSoft™

Made of 100% recycled fibers and contain a minimum of 40% post-consumer waste, which meets EPA guidelines.

30030217 49500 150 ct., 10 1/8" x 13", White 2400/cs.

EcoSoft™ Green Seal®

100% recycled and made entirely from recovered fibers. Natural towels contain up to 82% post-consumer waste and natural white towels contain up to 73% post-consumer waste.

30030493 49300 150 ct., 10 1/8" x 13", Natural White 2400/cs.

Multifold Towels



MULTIFOLD TOWELS

A. MULTIFOLD TOWELS

PRIME SOURCE®

Green Source™

100% recycled. Chlorine-free. EcoLogo™ Certified. Trilingual packaging (English, Spanish, French).

75009515	75009515	Natural	4000/cs.
75009510	75009510	White	4000/cs.

Hi-Valu

Universal paper towel are high quality and value priced. Ideal for all public environments.

73004307	73004307	200 ct., 9 ¹ / ₄ " x 9 ¹ / ₂ ", Natural	4000/cs.
73004306	73004306	200 ct., 9 ¹ / ₄ " x 9 ¹ / ₂ ", White	4000/cs.

Multifold Towels

High quality, value priced paper towel ideal for all public environments.

75004307	75004307	200 ct., 9 ¹ / ₈ " x 9 ¹ / ₂ ", Natural	4000/cs.
750043074	750043074	200 ct., 9 ¹ / ₈ " x 9 ¹ / ₂ ", Natural	4000/cs.
75004306	75004306	200 ct., 9 ¹ / ₈ " x 9 ¹ / ₂ ", White	20/200/cs.
750043064	750043064	200 ct., 9 ¹ / ₈ " x 9 ¹ / ₂ ", White	4000/cs.



B. MULTIFOLD TOWELS

GEORGIA-PACIFIC

Acclaim®

Economy multifold towels for reliable performance at a low cost.

13707630	20204	250 ct., 9 ¹ / ₄ " x 9 ¹ / ₂ ", 3 ¹ / ₄ " White	16/250/cs.
----------	-------	---	------------

Bigfold Z®

Premium towels with a new emboss that fits into existing C-fold and multifold dispensers (with no adapter required) to provide a premium, cost-saving C-fold substitute. Unique fold allows for reliable, one-at-a-time touchless dispensing which reduces the number of towels used as well as the risk of cross-contamination.

13700886	20887	220 ct., 10 ¹ / ₄ " x 11", White, 1-Ply	2200/cs.
----------	-------	---	----------

Envision®

Economical, EPA compliant multifold towels for reliable performance at a low cost.

13700233	23304	250 ct., 9 ¹ / ₄ " x 9 ¹ / ₂ ", Brown, 1-Ply	4000/cs.
----------	-------	--	----------

Signature®

Premium multifold hand towels provide softness and absorbency. Patented honeycomb pattern creates thick, luxurious softness.

13700218	21000	125 ct., 9 ¹ / ₄ " x 9 ¹ / ₂ ", White, 2-Ply	2000/cs.
----------	-------	--	----------



C. LINEN-LIKE® MULTIFOLD GUEST TOWELS

HOFFMASTER

Dress up your restroom countertops with Linen-Like® guest towels. Your patrons will appreciate this soft absorbent product versus the standard paper towel.

17803812	856499	12" x 17", White	500/cs.
----------	--------	------------------	---------

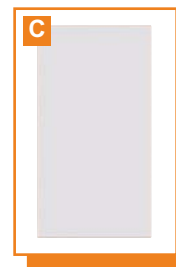

D. MULTIFOLD TOWELS

KIMBERLY-CLARK

Kleenex®

Premium towels set the standard for softness and absorbency; plus they will help reduce cost since fewer towels are needed per use.

15404600	0204600	150 ct., 9 ² / ₅ " x 9 ¹ / ₅ ", 1-Ply, White	8/cs.
15409040	01890	150 ct., 9 ¹ / ₃ " x 9 ² / ₅ ", 1-Ply, White	2400/cs.
15408130	88130	150 ct., 9 ¹ / ₄ " x 9 ¹ / ₂ ", 2-Ply, White	4/cs.

Kleenex® Scottfold®

Made to eliminate dispensing problems. Designed to dispense one-at-a-time, every time. Virtually eliminate tear-out and messy towel litter. Zip-Half Pack cases. Meet EPA standards with a minimum of 40% post-consumer waste.

15401900	01900	120 ct., 8 ¹ / ₁₀ " x 12 ² / ₅ ", White	2400/cs.
15401999	01999	120 ct., 9 ² / ₅ " x 12 ² / ₅ ", White	1920/cs.





Multifold Towels

PAPER PRODUCTS



A. MULTIFOLD TOWELS

KIMBERLY-CLARK

Scott® 100% RF

Made with 100% recycled fiber. Meets EPA standards for 40% minimum post-consumer waste content. Green Seal® Certified.

15401801	<i>01801</i>	250 ct., 9 ¹ / ₈ " x 9 ² / ₈ ", Natural, 1-Ply	4000/cs.
15401807	<i>01807</i>	250 ct., 9 ¹ / ₈ " x 9 ² / ₈ ", White, 1-Ply	4000/cs.

Scott®

Design allows for towels to dispense one-at-a-time for less waste, more value and a tidier washroom.

15400450	<i>01804</i>	250 ct., 9 ¹ / ₄ " x 9 ² / ₈ ", White, 1-Ply	4000/cs.
-----------------	--------------	--	----------

Scott® Scottfold®

Larger case size to reduce packaging waste; meets EPA standards with a minimum of 40% post-consumer recycled fiber and total minimum of 50% recycled fiber. The ideal replacement for C-folds. Dispenses one-at-a-time. Eliminates tabbing and tearing and easy to load. We guarantee 10% cost savings versus C-fold towels.

15401960	<i>01960</i>	8 ¹ / ₁₀ " x 12 ² / ₅ ", White, 1-Ply	4375/cs.
15401970	<i>01970</i>	9 ² / ₅ " x 12 ² / ₅ ", White, 1-Ply	3500/cs.
15401980	<i>01980</i>	9 ² / ₅ " x 12 ² / ₅ ", White, 1-Ply	4375/cs.

Tradition®

Design allows for towels to dispense one-at-a-time for less waste, more value and a tidier washroom.

15400026	<i>03650</i>	250 ct., 9 ² / ₅ " x 9 ³ / ₁₀ ", White, 1-Ply	3000/cs.
15401815	<i>01840</i>	250 ct., 9 ² / ₅ " x 9 ¹ / ₄ ", White, 1-Ply	4000/cs.

B. TORK® MULTIFOLD TOWELS

SCA TISSUE

Tork® Advanced

The unique three panel interfolded system, creates ready-to-use towels with no towel "fall out". Portion control, delivers one towel every time. Tork Advanced Xpress™ towels are easy to refill, reducing maintenance time & costs. Towels are made from 100% recycled fibers (EPA compliant) providing environmental benefits, and a positive image builder. EcoLogo™ Certified.

14101291	<i>101291</i>	144 ct., 8 ⁹ / ₁₀ " x 10"	3024/cs.
-----------------	---------------	---	----------

Soft and absorbent towels provide the right combination of quality, performance and value.

Embossing enhances hand feel and maximum performance. Made from 100% recycled fibers. High wet strength provides a premium quality people appreciate. Fast absorbency helps to control usage, so you save on reduced waste and maintenance time. "No touch" hand towel service offers sanitary conditions. Made from 100% recycled fibers, providing environmental benefits. A positive image builder. EcoLogo™ Certified. Replaces MB550.

14100550	<i>MB560A</i>	150 ct., 9 ¹ / ₂ " x 9 ¹ / ₈ ", White	2400/cs.
14103715	<i>MB550</i>	250 ct., 9 ¹ / ₂ " x 9 ¹ / ₈ ", White, Green Seal®	4000/cs.
14100551	<i>MB550A</i>	250 ct., 9 ¹ / ₂ " x 9 ¹ / ₈ ", White, Green Seal®	4000/cs.

Tork® Premium

Ultra soft and absorbent towels that provide a premium quality people appreciate. Multifold design provides for less towel consumption leading to source reduction, storage space savings, and lower overall costs. Excellent wet strength designed to please your most demanding users. Speedy absorbency helps to control usage, so you save on reduced waste and maintenance time. "No touch" hand towel service offers sanitary conditions. EcoLogo™ Certified.

14100575	<i>MB570</i>	150 ct., 9 ¹ / ₂ " x 9 ¹ / ₈ ", White	2400/cs.
-----------------	--------------	---	----------

Tork® Universal

Innovative towel service surpasses all other folded towel services in performance, value, and economy. Multifold design helps to minimize towel usage. Towels are made from 100% recycled fibers. EcoLogo™ Certified.

14100553	<i>MK518A</i>	250 ct., 9 ¹ / ₂ " x 8 ¹ / ₁₀ ", Natural, Green Seal®	4000/cs.
14100520	<i>MK520A</i>	250 ct., 9 ¹ / ₂ " x 9 ¹ / ₈ ", Natural, Green Seal®	4000/cs.
14100538	<i>MB540A</i>	250 ct., 9 ¹ / ₂ " x 9 ¹ / ₈ ", White	4000/cs.

Embossing enhances hand feel and maximum performance. Made from 100% recycled fibers. EcoLogo™ Certified.

14100552	<i>MK530A</i>	250 ct., 9 ¹ / ₂ " x 9 ¹ / ₈ ", Natural	4000/cs.
-----------------	---------------	---	----------

Multifold Towels/Singlefold Towels



A. LINENSAVER MULTIFOLD GUEST TOWELS SMITH LEE

Guest towels.

18101716 SL131716 15" x 17", 1/8 Fold 500/cs.



B. HEAVENLY SOFT™ MULTIFOLD TOWELS STEFCO

This individual multifold towel offers reliable performance at a low cost. Made from 100% recycled paper. Get maximum absorbency in an economical easy-to-dispense towel. Fits a wide range of folded towel dispensers.

57371231 61231 250 ct., 9 1/4" x 9 1/2", Bleached, 1-Ply 4000/cs.

57371229 61230 250 ct., 9 1/4" x 9 1/2", Natural, 1-Ply 4000/cs.



C. MULTIFOLD TOWELS WAUSAU PAPER/BAY WEST

DublSoft®

Premium DublSoft® folded towels absorb wetness quickly, reducing the number of towels needed per hand dry.

30030048 DS48 250 ct., 9 1/8" x 9 1/2", White 3000/cs.

DublSoft® Optifold®

A premium alternative to traditional folded towels. Features exclusive leaf embossing pattern. Offers maximum softness, strength and absorbency.

30030488 00488 250 ct., 10 1/4" x 9 1/2", White 3000/cs.

EcoSoft™

Made of 100% recycled fibers and contain a minimum of 40% post-consumer waste, which meets EPA guidelines.

30030004 48000 200 ct., 9 1/8" x 9 1/2", Natural 4000/cs.

30030005 48500 200 ct., 9 1/8" x 9 1/2", White 4000/cs.

EcoSoft™ Green Seal®

100% recycled and made entirely from recovered fibers. Natural towels contain up to 82% post-consumer waste and natural white towels contain up to 73% post-consumer waste.

30030483 48300 200 ct., 9 1/8" x 9 1/2", Natural White 4000/cs.



SINGLEFOLD TOWELS

D. SINGLEFOLD TOWELS PRIME SOURCE®

High quality, value priced paper towel ideal for all public environments.

750043013 750043013 268 ct., 9" x 10", Natural 4000/cs.

75004301 75004301 268 ct., 9" x 10", Natural 4000/cs.

750043014 750043014 268 ct., 9" x 10", Natural 4000/cs.

75004302 75004302 268 ct., 9" x 10", White 4000/cs.

750043024 750043024 268 ct., 9" x 10", White 4000/cs.



E. SINGLEFOLD TOWELS GEORGIA-PACIFIC

Acclaim®

Economy singlefold towels for reliable performance at a low cost. Folded: 5 5/16"W.

13707616 23504 250 ct., 9 1/2" x 10 5/8", Brown, 1-Ply 4000/cs.

Preference®

Embossed design and added thickness deliver absorbency customers will appreciate. Mid range sheet engineered for good quality and good value. Corrugate box makes for more efficient loading and unloading as well as storage. Folded: 5 5/8"W.

13700788 2078601 250 ct., 9 1/4" x 10 1/4", White, 1-Ply 4008/cs.



F. SCOTT® SINGLEFOLD TOWELS KIMBERLY-CLARK

Tailored for areas where function is just as important as quality.

15401700 01700 250 ct., 10 1/2" x 9 1/8", White 4000/cs.



PAPER PRODUCTS



Singlefold Towels/Roll Towel Dispensers

PAPER PRODUCTS



A. TORK® UNIVERSAL SINGLEFOLD TOWELS SCA TISSUE

Soft and absorbent towels provide the right combination of quality, performance and value. Embossing enhances hand feel and maximum performance. Singlefold design provides quality people appreciate while working to reduce your overall costs. Fits all standard singlefold towel dispensers. Second fold creates a second 1/2" tab to aid dispensing. Made from 100% recycled fibers, providing environmental benefits. A positive image builder. Replaces SB1840. EcoLogo™ Certified.

14101855	SK1850A	250 ct., 10 ¹ / ₄ " x 9 ¹ / ₈ ", 5 ¹ / ₁₀ " x 9 ¹ / ₈ " Folded, Natural	4000/cs.
14101841	SB1840A	250 ct., 10 ¹ / ₄ " x 9 ¹ / ₄ ", 5 ¹ / ₈ " x 9 ¹ / ₄ " Folded, White	4000/cs.



B. SINGLEFOLD TOWELS WAUSAU PAPER/BAY WEST

EcoSoft™

Made of 100% recycled fibers and contain a minimum of 40% post-consumer waste, which meets EPA guidelines.

30030090	47000	268 ct., 9" x 10", Natural	4020/cs.
30030092	47500	268 ct., 9" x 10", White	4020/cs.

EcoSoft™ Green Seal®

100% recycled and made entirely from recovered fibers. Natural towels contain up to 82% post-consumer waste and natural white towels contain up to 73% post-consumer waste.

30030091	47300	268 ct., 9" x 10", Natural White	4020/cs.
-----------------	--------------	----------------------------------	----------



ROLL TOWEL DISPENSERS

C. HANDS-FREE TOWEL DISPENSER PRIME SOURCE®

Translucent black towel dispenser.

75004345	75004345	11 ¹ / ₁₆ " x 16 ¹ / ₁₆ " x 9 ⁷ / ₁₆ ", Black Translucent	1/ea.
-----------------	-----------------	---	-------



D. ROLL TOWEL DISPENSERS PRIME SOURCE®

Translucent black towel dispensers.

Button Lever

75004335	75004335	11 ¹ / ₂ " x 15 ¹ / ₈ " x 10 ¹ / ₂ "	1/ea.
-----------------	-----------------	--	-------

Lever

750043391	75004339	11 ¹ / ₂ " x 15 ¹ / ₈ " x 10 ¹ / ₂ "	1/ea.
------------------	-----------------	--	-------

Mechanical Hands-Free

75004336	75004336		1/ea.
-----------------	-----------------	--	-------

E. WAVE 'N DRY ROLL TOWEL DISPENSERS PRIME SOURCE®

The first roll towel system to offer totally touch-free dispensing. The towel is stored fully protected inside the dispenser until you request service by passing your hand or arm near the sensor. There are no levers, buttons, or cranks to touch.

75004341	75004341	12" x 15 ⁷ / ₈ " x 10 ³ / ₈ ", Black Translucent	1/ea.
75004348	75004348	Black Translucent	1/ea.
75004378	75004378	White	1/ea.



Roll Towel Dispensers



A. IN-SIGHT® SANITOUCH® ROLL TOWEL DISPENSER KIMBERLY-CLARK

Better stub roll feature. Quieter sound. Easier to see tail of paper. Shorter sheet size for better economy.
15409990 09990 12²/₃" x 16¹/₃" x 10¹/₅", Smoke 1/ea.



B. IN-SIGHT SERIES-I LEV-R-MATIC® ROLL TOWEL DISPENSER KIMBERLY-CLARK

New curved silhouette adds aesthetic appeal. Made of high-impact plastic with a smoked transparent cover. Easy roll loading and automatic sheet feed. Dispenses (1) 8" roll and (1) 3¹/₂" diameter roll with 1¹/₂" diameter cores. Features a metal key operated lock, optional user installed knob (for lock operation), lever operated dispensing mechanism and stub roll.
15409765 09765 13¹/₃"W x 13¹/₂"H x 9⁴/₅"D, Smoke Gray 1/ea.



C. ROLL TOWEL STARTER KIT KIMBERLY-CLARK

Includes one towel dispenser and one roll of towels.
15408076 08076 Non-Perforated 1/ea.



D. INTEGRA™ ROLL TOWEL DISPENSER SAN JAMAR

Universal dispenser works with any brand or quality of hardwound roll towels. Easy to load and dispenses with simple push of lever. Break-resistant plastic construction.
62570850 T850TBK 13¹/₂"H x 11¹/₂"W x 11¹/₄"D, Black Pearl 1/ea.



E. JAZ ROLL TOWEL DISPENSER SAN JAMAR

Intended for employee use. Contemporary, non-portioned controlled dispenser allows for quick and easy clean ups. Patented tooth pattern allows for easy tearing of the towel. High-impact plastic construction. Holds one 8" wide roll.
62570751 T750 9³/₄" x 12" x 12³/₄", Pearl White 1/ea.



F. LEVER ROLL TOWEL DISPENSER SAN JAMAR

Larger capacity dispenser. Bio-Pruf™ treated handle resists bacterial growth. Universal to work with all types of roll towels. Made of break-resistant plastic. Capacity: (1) 8"W x 8¹/₂" diameter roll and up to 4" stub roll.
62570096 T1100TBK 16¹/₂"H x 12¹⁵/₁₆"W x 9¹/₄"D, Black Pearl 1/ea.



G. SAVVY™ UNIVERSAL LEVER ROLL TOWEL DISPENSERSAN JAMAR

Universal and dispenses any quality of paper. Continual availability of paper is provided by the Infinity® System automatic transfer, eliminating stub roll waste. Break-resistant plastic.
62571292 T1200TBK 16¹/₂" x 12¹⁵/₁₆" x 9¹/₄", Black Pearl 1/ea.



H. SIMPLICITY HANDS-FREE TOWEL DISPENSER SAN JAMAR

The Simplicity expands San Jamar's hands free dispensing options with a Mechanical Hands Free Dispenser. It offers hands free dispensing of most types of roll towel. Does not require batteries. Fast paper delivery because there is no need to wait for a sensor. Automatic mechanical cutting dispenses consistent 11" portions of roll towel.
625714931 T7000TBK 16.09" x 11.82" x 9.25", Black Pearl 1/ea.



I. SMART SYSTEM WITH IQ SENSOR™ TOUCHLESS ROLL TOWEL DISPENSER SAN JAMAR

Offers the versatility and reliability of the Smart System with the added features of the IQ Sensor™. Holds (1) 8" wide x 8" diameter roll and (1) 4" stub roll. Dual mode - sensor mode and paper out. Consistent performance throughout the battery's entire lifespan. Infinity® System auto transfer to eliminate stub roll waste.
62571480 T1400TBK 16¹/₂"H x 11³/₄"W x 9¹/₄"D, Black Pearl 1/ea.



J. TEAR-N-DRY™ ELECTRONIC TOUCHLESS ROLL TOWEL DISPENSER SAN JAMAR

A simple hands-free alternative. Provides 10" paper portions every time without a wait. Because there is no need to wait for a sensor this dispenser is ideal for high traffic areas. Has the longest battery life in the industry, requiring less maintenance. No adjustments needed; just mount and go. Holds (1) 8" wide roll; (1) 8¹/₂" diameter and (1) 4" stub roll.
62571300 T1300TBK 16¹/₂"H x 11³/₄"W x 9¹/₄"D, Black Pearl 1/ea.



PAPER PRODUCTS



Roll Towel Dispensers

PAPER PRODUCTS



A. TORK ELEVATION MATIC® HAND TOWEL ROLL DISPENSERS SCA TISSUE

The design ensures easy and intuitive maintenance, refilling and use. High capacity dispenser is ideal for busy washrooms. Hands free dispensing provides a hygienic, one-at-a-time solution for your washroom. The user touches only the towel needed, reducing the risk of cross-contamination. Semi-transparent cover makes it easy to see when a refill is needed. Push bar for loading and emergency feeds. Utilizes any Tork H1 Roll Towel.

14100421	551028A	Black	1/ea.
14100420	551020A	White	1/ea.



B. TORK® HAND TOWEL ROLL DISPENSER SCA TISSUE

Translucent cover allows for "at a glance" inspection for refills. Smooth cover with no recesses is easy to clean and maintain. Lever controlled consumption means less waste, lower costs. Stub roll auto-transfer feature, built-in pilferage control. High impact plastic and design help prevent breakage. Holds one roll.

14102084	84TR	Lever Auto Transfer, Smoke	1/ea.
-----------------	------	----------------------------	-------



C. TORK® INTUITION HAND TOWEL ROLL DISPENSERS SCA TISSUE

The touch-free electronic Tork® Intuition virtually eliminates cross contamination while cutting back on supply waste. Each unit features a choice of two dispensing modes. The sensor mode, in which the towel remains inside the cabinet until the user activates the sensor delivers maximum hygiene. The hanging mode, in which a single towel is exposed for immediate access, is ideal for high-traffic venues. The adjustable towel length, adjustable time delay of less than one second to over four seconds, and a stub roll compartment combine to deliver more precise control of consumption. Can be mounted directly to wall or within a recessed compartment. Numerous back-plate mounting slots fit most any pattern. Utilizes Tork® Towels - smart solution one paper SKU - any Tork® roll towel fits into Tork® Intuition Dispensers for automatic hands-free Tork® dispensing. Uses three D size batteries.

14109609	309609A	Black	1/ea.
14109606	309606	White	1/ea.



D. TORK® MATIC HAND TOWEL ROLL DISPENSER SCA TISSUE

Tork® Matic is a portion controlled, mechanical hands-free dispensing system for roll towels that provides hygienic dispensing without the need for handles or levers. The user touches only the towel needed - reducing the risk of cross-contamination. Reliable and durable, Tork® Matic delivers one towel, time after time, always ready to service the next patron. Tork® Matic is the ideal dispenser for high traffic restrooms in office and public buildings as well as industrial, healthcare and foodservice settings. Holds one roll.

14109202	309201	14 ³ / ₅ "H x 12 ³ / ₅ "W x 8"D, White	1/ea.
-----------------	--------	--	-------



E. SILHOUETTE® OPTISERV™ HANDS-FREE ROLL TOWEL DISPENSER WAUSAU PAPER/BAY WEST

This hands-free dispenser only requires you to touch your personal towel, reducing the chance for cross-contamination from touching commonly used surfaces such as levers or buttons. Ideal for food preparation and healthcare environments. Accommodates up to an 800' roll along with a 4" stub roll to optimize dispenser capacity and save maintenance time. Dispenses and cuts a pre-measured 11" towel for maximum usage control. ADA compliant when installed according to the Guidelines for Accessible Design. Side-hinged door for ease when opening and loading the dispenser. Supports the principles of HACCP.

30036531	86500	11 ¹¹ / ₁₆ " x 16 ¹¹ / ₁₆ " x 9 ⁷ / ₁₆ ", Black Translucent	1/ea.
-----------------	-------	---	-------



F. SILHOUETTE® WAVE'N DRY® HANDS-FREE ROLL TOWEL DISPENSER WAUSAU PAPER/BAY WEST

The Wave'n Dry® dispenser pioneered the touch free towel dispensing market. The first electronic roll towel system to offer totally touch free dispensing. The only thing you touch is your personal towel. The towel is stored fully protected inside the dispenser until you request service by passing your hand or arm underneath the sensor. There are no levers, buttons or cranks to touch. This is particularly important in public restrooms, food preparation and healthcare environments where prevention of cross-contamination is a concern. Supports the principles of HACCP.

30030144	80010	12" x 15 ⁷ / ₈ " x 10 ³ / ₈ ", Black Translucent	1/ea.
-----------------	-------	--	-------

Centerpull Towel Dispensers/Folded Towel Dispensers



CENTERPULL TOWEL DISPENSERS

A. IN-SIGHT® ROLL CONTROL CENTERPULL TOWEL DISPENSER KIMBERLY-CLARK

In-Sight® roll control dispensers with the Scott® roll control centerpull towels introduce a center-flow system that reduces dispensing problems (streaming, lost tail, crumpled sheet appearance). Our system also provides more hand driers per case than singlefold, C-fold, and M-fold towels to make it economical and very effective for hand drying needs.

15409989 09989 10¹/₄" x 11⁷/₈" x 9¹/₄", Smoke Gray 1/ea.



B. CENTERPULL TOWEL DISPENSER SAN JAMAR

A large capacity dispenser designed to reduce maintenance costs and provide a hygienic hand drying environment. Large capacity ensures long intervals between refills. Dispenses single sheets of perforated centerpull towel for reliable portion control. Touchless centerpull design helps prevent cross-contamination. Holds one 9¹/₂"W, 9" diameter roll.

62570752 T400TBK 12"H x 9"W x 10"D, Black Pearl/White Sand 1/ea.

C. TORK® HAND TOWEL CENTERFEED DISPENSERS SCA TISSUE

Tork® Centerfeed high capacity cabinets are ideal for high traffic environments. Cabinets are hygienic. You only touch the towel you use. No cross contamination from levers or cranks. The Portion Control feature dispenses one towel every time. The one hand dispensing is ideal for many environments, workshops and kitchens. Cabinets are simple and reliable offering low maintenance costs. Holds one roll.

14102092 302092 15"H x 9¹/₂"W x 8⁴/₅"D, Quartz 1/ea.

14102090 302090 15"H x 9¹/₂"W x 8⁴/₅"D, White 1/ea.

See-through smoke design reduces maintenance and allows quick and easy service checks. Elegant appearance complements any decor. High-impact flame retardant, chemical-resistant, rigid vinyl plastic provides low maintenance. The hinged door and adjustable port offers trouble free service. No touch, hands free dispensing offers a sanitary benefit. Uses 7¹/₂" diameter rolls.

14100493 93T 12³/₄"H x 10¹/₈"W x 10"D, Smoke/Gray 1/ea.



D. STEFCO CENTERPULL TOWEL DISPENSER STEFCO

Dispenses a variety of perforated one and two-ply roll towels and light-duty wipers in pre-measured single sheets through a patented self-adjusting dispensing device. No funnels or dispensing devices to adjust. Side-opening cover allows for simple loading.

57371000 91000 Black Base/Smoke Cover 1/ea.



E. SILHOUETTE® CENTERPULL TOWEL DISPENSER WAUSAU PAPER/BAY WEST

Very user-friendly and requires only one hand to easily dispense soft, absorbent EcoSoft™ towels. Ideal for healthcare, food preparation and laboratory areas.

30030681 68100 9³/₄" x 13¹/₂" x 9¹/₂", Black Translucent 1/ea.

C-FOLD/MULTIFOLD TOWEL DISPENSERS

F. COMBO TOWEL CABINETS CCP

Holds both multifold and C-fold towels. Heavy gauge steel with see-through towel gauge and hinged locking cabinet.

276015491 989SS 15³/₈" x 11¹/₄" x 4¹/₁₆", Stainless Steel 1/ea.

276015521 990W 15³/₈" x 11¹/₄" x 4¹/₁₆", White 1/ea.

276015551 991C 15³/₈" x 11¹/₄" x 4¹/₁₆", Chrome 1/ea.



G. TRUEFOLD™ C-FOLD/MULTIFOLD DISPENSER SAN JAMAR

Flip door feature allows transformation to a true C-fold or multifold cabinet. Eliminates costly excess multi-towel dispensing. Metal front with unbreakable plastic back. Maximum towel size: 10¹/₄"W x 3³/₄"D. Holds up to 300 C-fold or 500 multifold towels.

625700411 T1905 14¹/₂"H x 11⁵/₈"W x 5"D, White 1/ea.

62570041 T1905 14¹/₂"H x 11⁵/₈"W x 5"D, White 5/cs.



Folded Towel Dispensers/Feminine Hygiene



PAPER PRODUCTS



A. OCEANS™ ULTRAFOLD TOUCHLESS FOLDED TOWEL DISPENSER **SAN JAMAR**
 Larger capacity with slimmer profile. Patented mouth dispenses C-fold and multifold towels. Designed to eliminate overloading of towels. Holds up to 450 C-fold or 750 multifold towels.
62571795 T1790WS 18"H x 11¾"W x 6¼"D, White Sand 5/cs.

B. PRESENT® SYSTEM FOLDED TOWEL DISPENSER **SAN JAMAR**
 Multifold/C-fold towel dispenser. Low profile design makes this dispenser ideal for small places. The Present® System unfolds the towel for full sheet use and one-at-a-time towel presentation of C-fold or multifold towels. Adhesive backs for easy mounting. Break-resistant plastic. Hold up to two sleeves.
62571750 T1750TBK 11½" x 11½" x 6", Black Pearl 1/ea.

C. ULTRAFOLD PRESENT® FOLDED TOWEL DISPENSER **SAN JAMAR**
 Offers a touchless, smooth towel presentation that is 50% more capacity than a standard folded towel dispenser. Higher capacity reduces refill of towels. Capacity: three full sleeves.
62570700 T1700TBK 18"H x 11¾"W x 6¼"D 1/ea.

SINGLEFOLD DISPENSERS

D. SINGLEFOLD TOWEL CABINETS **CCP**
 Features sturdy piano hinge and see through towel gauge for at-a-glance reference. Self-locking cabinet holds two packages of standard singlefold towels.
276063011 630C 7½" x 12¹³/₁₆" x 6½", Chrome 1/ea.
276006331 630W 7½" x 12¹³/₁₆" x 6½", White 1/ea.
27600633 630W 7½" x 12¹³/₁₆" x 6½", White 6/cs.

TAMPONS

E. TAMPONS **HOSPECO**
Maxithins® Comfort plus
 Regular absorbency, open end tampon with sewn-in cord. All flushable and biodegradable.
14500100 MT100FS 100 ct. 100/cs.
14500010 MT500 500 ct. 500/cs.
Tampax®
 Original regular Tampax® tampons individually wrapped in vending tube.
14501010 T500 500 ct. 500/cs.

SANITARY NAPKINS

F. SANITARY NAPKINS **HOSPECO**
Enviro Gards® Ultra Thin
 A super absorbent sanitary napkin that it is both flushable and biodegradable. Specially engineered, patented materials combine to make the only flushable and biodegradable sanitary napkin available for restroom feminine hygiene vending.
14502004 EG4 #4 Box 125/cs.
Gards®
 Gards #4 pads in vending box. For use in: Dual #1, Tri #74, FOC, FOCJR, ED-1, Dual #7, K-20H, K-40H, J1, 62 J6N, J6, 4-J, J10, J50, J31, J75.
14502147 4147 4¼" x 3" x 1" 250/cs.
Maxithins®
 Maxi sanitary napkins in No. 4 box.
14500040 MT4 #4 Box 250/cs.
 4n4 channel maxi pads in No. 4 box.
14500480 MT480 4¼" x 3" x 1" Vend Box 250/cs.
 Maxi sanitary napkins in No. 8 box.
14500080 MT8 8" x 3¼" x 8" Vend Box 250/cs.
Maxithins® Ultra Thin Maxis w/Wings
 Larger wings for a more secure fit. Ultra thin core for discreet protection. Dri-Gard cover sheet for superior dryness and comfort. No. 4 size vending box.
14500200 MT200 4¼" x 3" x 1" Vend Box 200/cs.

Feminine Hygiene



NAPKIN RECEPTACLE LINERS

A. SANITARY NAPKIN RECEPTACLE LINERS CCP

Kraft paper liners. Fit #250 receptacle.

27601198 250K 11¹/₄" x 7¹/₂" x 3" 2/250/cs.

B. SANITARY NAPKIN RECEPTACLE LINERS HOSPECO

Health Gards®

Kraft liner for floor type receptacles.

14506802 6802W 8" x 7" x 8", Kraft 500/cs.

Health Gards® Waxed

Kraft wax paper liners, with gusset wax finish.

14500147 KL260 7¹/₂" x 3¹/₂" x 10¹/₄" 500/cs.

Kraft waxed paper liners. With gusset-wax finish. Fit Sanisac and #250, #201W, #ND1W, #ND1E receptacles. 100% recycled post-consumer waste.

14502200 260 10¹/₄" x 7¹/₂" x 3¹/₂" 900/cs.

Waxed paper liners for use in Hospital Specialty HS6140. Replaces RM liners or RCP 6141.

14500123 HS6141 9" x 10" x 3¹/₄" 250/cs.

C. SANITARY NAPKIN WAXED BAGS RUBBERMAID

Waxed bags for sanitary napkin receptacle. 50 bags/bundle; 250 per carton. Fits #6140 receptacle.

17708844 6141 9³/₄" x 3³/₄" x 9⁷/₈"H, Kraft 250/cs.



SANITARY NAPKIN RECEPTACLES

D. HEALTH GARDS® SANITARY NAPKIN RECEPTACLE HOSPECO

Swing top, double entry, metal floor receptacle.

14502202 2201 9" x 9" x 10³/₄", White 1/ea.

E. HEALTH GARDS® SANITARY NAPKIN RECEPTACLE HOSPECO

Wall receptacle made of ABS plastic.

14500004 250201W White 1/ea.

F. HEALTH GARDS® SANITARY NAPKIN RECEPTACLE HOSPECO

Wall mount napkin receptacle.

145000131 ND1E Stainless Steel 1/ea.

G. SANITARY NAPKIN RECEPTACLE RUBBERMAID

Space efficient and easy-to-service. Tight-fitting lid helps contain odor. Removable rigid liner is easy to clean. Five waxed paper bags included.

17708842 6140 12¹/₂" x 5¹/₄" x 10³/₄"H, White 1/ea.



FEMININE HYGIENE VENDING

H. E-VENDOR FEMININE HYGIENE VENDING MACHINE HOSPECO

E-Vendor consists of the popular Dual-1 vendor with an electronic warning signal indicating dispenser stock levels. When stock is low, a bright red light flashes "EMPTY", alerting maintenance personnel that it is time to restock. Dispenses (15) boxes size No. 4-147 or MT-4 sanitary napkins and (25) vended tampons.

14505552 ED150 \$.25 Coin Release, White 1/ea.





Feminine Hygiene/Toilet Seat Covers/Dispenser/Bands

PAPER PRODUCTS



A. FEMININE HYGIENE VENDING MACHINE HOSPECO

Dual No.1 vendor dispenses (15) boxes of Size No.4-147 or MT-4 sanitary napkins and 25 vended tampons.
14500088 D125 \$.25 Coin Release, White 1/ea.

B. TAMPAX® FEMININE HYGIENE VENDING MACHINE HOSPECO

Includes: Tampon vending machine, No. 4 boxes, and 25 Maxithins® tampons.
14500311 MT1 1/ea.

TOILET SEAT COVERS

C. TOILET SEAT COVERS PRIME SOURCE®

Biodegradable covers are safe for all septic tanks. Will fit most seat cover dispensers.
75004370 75004370 250 ct., 1/2 Fold 5M/cs.
75004372 75004372 1/2 Fold 1M/cs.



D. SAFE-T-GARD® SEAT COVERS GEORGIA-PACIFIC

Quality paper seat covers for a protective barrier at an economical cost.
13707046 47046 250 ct., 1/2 Fold, White 5000/cs.



E. DISCREET SEAT™ TOILET SEAT COVERS HOSPECO

Very cost-effective, hygienic way to cover public seats.
14505000 DS5000 250 ct., 1/2 Fold, White 5000/cs.



F. HEALTH GARDS® TOILET SEAT COVER REFILLS HOSPECO

For environmentally concerned customers. Made from 100% recycled paper. Disposable and flushable.
14505001 GREEN5000 250 ct., 1/2 Fold, Green 5000/cs.
14500291 HG1000 1000 ct., 1/2 Fold 1000/cs.
14502025 HG2500 2500 ct., 1/2 Fold 2500/cs.
14504650 HG5000 5000 ct., 1/2 Fold 5000/cs.
14502026 HGQTR5M 5000 ct., 1/4 Fold 5000/cs.



G. SCOTT® PERSONAL SEATS KIMBERLY-CLARK

Flushable to help reduce litter and clogging. Meets EPA guidelines for post-consumer waste.
15400379 07410 125 ct., 15" x 18" 3000/cs.



H. TORK® UNIVERSAL TOILET SEAT COVERS SCA TISSUE

An easily dispensable, ready-for-use format. Hygienic, protects users from cross-contamination.
14100109 TC0020 250 ct., 1/2 Fold, White 20/250/cs.



I. ECOSOFT™ GREEN SEAL® TOILET SEAT COVERS WAUSAU PAPER/BAY WEST

These Green Seal® Certified seat covers are 100% recycled, contain 20% post-consumer waste and feature environmentally preferable packaging. Provides superior sanitary protection.
30031949 19490 250 ct., 14½" x 17", White, 1-Ply 5000/cs.



TOILET SEAT COVER DISPENSER

J. HEALTH GARDS® TOILET SEAT COVER DISPENSER HOSPECO

Toilet seat cover dispenser holds two sleeves of 1/2 fold seat covers.
14504315 HG12 (2) 250 ct., White 2/cs.



TOILET SEAT BANDS

K. TOILET SEAT BANDS BAGCRAFT/PAPERCON

White kraft paper toilet seat band with Sani-Shield® logo.
10900591 300591 1½" x 16", Blue/Yellow Print 1000/cs.



Baby Changing/Bath Mats & Towels



BABY CHANGING

A. PRECIOUS® BABY CHANGING STATION HOSPECO

A necessity for every restroom. Folds up and lies flat against the wall when not in use. Includes two diaper compartments. Recommended installation meets ADA accessibility guidelines. Offers highest degree of safety with a horizontal wall-mount, keeping baby and adult close.

14506217 67016 Changing Table 1/ea.



B. PRECIOUS® BABY CHANGING TABLE LINERS HOSPECO

Disposable liners help guard against the transmission of infection.

14507017 67015 13" x 10³/₄", Liners 500/cs.

C. BABY CHANGING STATION RUBBERMAID

Horizontal baby changing stations meet all global safety standards (ASTM, ADA, FDA, EN).

Features antimicrobial protection, easy reach hooks and built-in shelf and liner storage.

17701888 781888 Light Platinum 1/ea.



BATH MATS

D. SAFTI-GRIP® BATH MATS RUBBERMAID

Perfect for shower stall or bathtub. Suction-backed to stay firmly in place.

17709101 703504 22¹/₂" x 14", Medium 4/cs.

17709105 704104 28" x 16", Large 4/cs.

E. BATH MAT SMITH LEE

A stock bath mat that is printed and embossed on highly absorbent wet strength paper stock.

18107600 25100 14¹/₂" x 20¹/₂", White, Plain 500/cs.



BATH TOWELS

F. WYPALL® DRY-UP® PROFESSIONAL TOWELS KIMBERLY-CLARK

Multi-purpose, absorbent bath-sized towels that reduce the cost and hassles of laundering and pilferage. Ideal for health clubs, mining/manufacturing and schools.

15407981 35010 100 ct., 22¹/₂" x 39", White 300/cs.



Disposable Gloves



VINYL/POLY GLOVES

A. HANDSOFF® SENSI-PRO DISPOSABLE GLOVES PRIME SOURCE®

High quality, single-use gloves. Protection against animal fats, oil-based solvents, petroleum, caustics and acids. Three times the strength and puncture-resistance of conventional disposable gloves. 9 1/2" length with rolled cuff. Fit either hand. Packaged in a dispenser box.

Lightly Powdered

75008825	75008825	Small, Beige, 5 MIL	400/cs.
75008826	75008826	Small, Beige, 5 MIL	1000/cs.
75008824	75008824	Small, Blue, 5 MIL	400/cs.
75008820	75008820	Small, White, 5 MIL	400/cs.
75008821	75008821	Small, White, 5 MIL	1000/cs.
75008835	75008835	Medium, Beige, 5 MIL	400/cs.
75008836	75008836	Medium, Beige, 5 MIL	1000/cs.
75008834	75008834	Medium, Blue, 5 MIL	400/cs.
75008830	75008830	Medium, White, 5 MIL	400/cs.
75008831	75008831	Medium, White, 5 MIL	1000/cs.
75008845	75008845	Large, Beige, 5 MIL	400/cs.
75008846	75008846	Large, Beige, 5 MIL	1000/cs.
75008844	75008844	Large, Blue, 5 MIL	400/cs.
75008840	75008840	Large, White, 5 MIL	400/cs.
75008841	75008841	Large, White, 5 MIL	1000/cs.
75008855	75008855	X-Large, Beige, 5 MIL	400/cs.
75008856	75008856	X-Large, Beige, 5 MIL	1000/cs.
75008854	75008854	X-Large, Blue, 5 MIL	400/cs.
75008850	75008850	X-Large, White, 5 MIL	400/cs.
75008851	75008851	X-Large, White, 5 MIL	1000/cs.

Powder-Free

75008925	75008925	Small, Beige, 5 MIL	400/cs.
75008926	75008926	Small, Beige, 5 MIL	1000/cs.
75008924	75008924	Small, Blue, 5 MIL	400/cs.
75008920	75008920	Small, White, 5 MIL	400/cs.
75008921	75008921	Small, White, 5 MIL	1000/cs.
75008935	75008935	Medium, Beige, 5 MIL	400/cs.
75008936	75008936	Medium, Beige, 5 MIL	1000/cs.
75008934	75008934	Medium, Blue, 5 MIL	400/cs.
75008931	75008931	Medium, White, 5 MIL	1000/cs.
75008930	75008930	Medium, White, 5 MIL	400/cs.
75008945	75008945	Large, Beige, 5 MIL	400/cs.
75008946	75008946	Large, Beige, 5 MIL	1000/cs.
75008944	75008944	Large, Blue, 5 MIL	400/cs.
75008940	75008940	Large, White, 5 MIL	400/cs.
75008941	75008941	Large, White, 5 MIL	1000/cs.
75008955	75008955	X-Large, Beige, 5 MIL	400/cs.
75008956	75008956	X-Large, Beige, 5 MIL	1000/cs.
75008954	75008954	X-Large, Blue, 5 MIL	400/cs.
75008950	75008950	X-Large, White, 5 MIL	400/cs.
75008951	75008951	X-Large, White, 5 MIL	1000/cs.



Disposable Gloves



A. HANDSOFF® POLYETHYLENE DISPOSABLE GLOVES PRIME SOURCE®

Economical, single-use poly gloves with a lightly embossed surface. Easy to slip on and off. Fit either hand. Packaged in a dispenser box. Clear.

75007110	75007110	X-Small, 100/Box	10,000/cs.
75007125	75007125	Small, 500/Box	10,000/cs.
75007120	75007120	Small, 100/Box	10,000/cs.
75007122	75007122	Small, 500/Box	2000/cs.
75007123	75007123	Small, 500/Box	10,000/cs.
75007135	75007135	Medium, 500/Box	10,000/cs.
750071305	75007130	Medium, Embossed, 100/Box	1000/cs.
75007130	75007130	Medium, Embossed, 100/Box	10,000/cs.
750071395	75007139	Medium, Economy, 100/Box	1000/cs.
75007139	75007139	Medium, Economy, 100/Box	10,000/cs.
75007132	75007132	Medium, 500/Box	2000/cs.
75007133	75007133	Medium, 500/Box	10,000/cs.
75007145	75007145	Large, 500/Box	10,000/cs.
750071495	75007149	Large, 100/Box	1000/cs.
75007149	75007149	Large, 100/Box	10,000/cs.
750071405	75007140	Large, 100/Box	1000/cs.
75007140	75007140	Large, 100/Box	10,000/cs.
75007147	75007147	Large, 100/Header	10,000/cs.
75007142	75007142	Large, 500/Box	2000/cs.
75007143	75007143	Large, 500/Box	10,000/cs.
750071595	75007159	X-Large, 100/Box	1000/cs.
75007159	75007159	X-Large, 100/Box	10,000/cs.
75007157	75007157	X-Large, 100/Header	10,000/cs.
750071505	75007150	X-Large, 100/Box	1000/cs.
75007150	75007150	X-Large, 100/Box	10,000/cs.
75007152	75007152	X-Large, 500/Box	2000/cs.
75007153	75007153	X-Large, 500/Box	10,000/cs.

Premium Grade

75007126	75007126	Small, 1 MIL, 100/Box	1000/cs.
75007136	75007136	Medium, 1 MIL, 100/Box	1000/cs.
75007146	75007146	Large, 1 MIL, 100/Box	1000/cs.
75007156	75007156	X-Large, 1 MIL, 100/Box	1000/cs.

B. HI-VALU POLYETHYLENE GLOVES PRIME SOURCE®

Economical, single-use poly gloves with a lightly embossed surface. Easy to slip on and off. Fit either hand. Packaged in a dispenser box.

73007122	73007122	Small, 500/Box	2000/cs.
73007132	73007132	Medium, 500/Box	2000/cs.
73007142	73007142	Large, 500/Box	2000/cs.
73007152	73007152	X-Large, 500/Box	2000/cs.

C. HANDSOFF® MICRO CLEAN™ DISPOSABLE GLOVES PRIME SOURCE®

High quality, powder-free single-use gloves. Synthetic material with anti-microbial additives. Non-latex and non-allergenic. Fit either hand. Packaged in a dispenser box. White.

75008731	75008731	Medium, 5 MIL	400/cs.
75008741	75008741	Large, 5 MIL	400/cs.

Disposable Gloves



A. HANDSOFF® VINYL DISPOSABLE GLOVES PRIME SOURCE®

High quality single-use vinyl gloves. Increased sensitivity and stretch-to-fit.

Lightly Powdered

75006111	75006111	X-Small, 5 MIL	400/cs.
75006110	75006110	X-Small, 5 MIL	1000/cs.
75006121	75006121	Small, 5 MIL	400/cs.
75006120	75006120	Small, 5 MIL	1000/cs.
75006621	75006621	Small, Blue, 5 MIL	400/cs.
75006620	75006620	Small, Blue, 5 MIL	1000/cs.
75006131	75006131	Medium, 5 MIL	400/cs.
75006130	75006130	Medium, 5 MIL	1000/cs.
75006631	75006631	Medium, Blue, 5 MIL	400/cs.
75006630	75006630	Medium, Blue, 5 MIL	1000/cs.
75006141	75006141	Large, 5 MIL	400/cs.
75006140	75006140	Large, 5 MIL	1000/cs.
75006641	75006641	Large, Blue, 5 MIL	400/cs.
75006640	75006640	Large, Blue, 5 MIL	1000/cs.
75006151	75006151	X-Large, 5 MIL	400/cs.
75006150	75006150	X-Large, 5 MIL	1000/cs.
75006651	75006651	X-Large, Blue, 5 MIL	400/cs.
75006650	75006650	X-Large, Blue, 5 MIL	1000/cs.
75006155	75006155	2X-Large, 5 MIL	1000/cs.

Powder-Free

75006210	75006210	X-Small, 5 MIL	1000/cs.
75006220	75006220	Small, 5 MIL	1000/cs.
75006720	75006720	Small, Blue, 5 MIL	1000/cs.
750062305	75006230	Medium, 5 MIL	100/bx.
75006231	75006231	Medium, 5 MIL	400/cs.
75006230	75006230	Medium, 5 MIL	1000/cs.
75006730	75006730	Medium, Blue, 5 MIL	1000/cs.
75006241	75006241	Large, 5 MIL	400/cs.
75006240	75006240	Large, 5 MIL	1000/cs.
75006740	75006740	Large, Blue, 5 MIL	1000/cs.
75006251	75006251	X-Large, 5 MIL	400/cs.
75006250	75006250	X-Large, 5 MIL	1000/cs.
75006750	75006750	X-Large, Blue, 5 MIL	1000/cs.
75006255	75006255	2X-Large, 5 MIL	1000/cs.



B. HANDSOFF® VINYL GENERAL PURPOSE GLOVES PRIME SOURCE®

General purpose, single-use vinyl gloves. 10"L with rolled cuff.

Lightly Powdered

75006160	75006160	Small, 3 MIL	1000/cs.
75006170	75006170	Medium, 3 MIL	1000/cs.
75006180	75006180	Large, 3 MIL	1000/cs.
75006190	75006190	X-Large, 3 MIL	1000/cs.

Powder-Free

75006260	75006260	Small, 3 MIL	1000/cs.
75006270	75006270	Medium, 3 MIL	1000/cs.
75006281	75006281	Large, 3 MIL	400/cs.
75006280	75006280	Large, 3 MIL	1000/cs.
75006290	75006290	X-Large, 3 MIL	1000/cs.





Disposable Gloves

LATEX GLOVES



A. HI-VALU LATEX GLOVES

PRIME SOURCE®

High quality, single-use latex gloves. Fit either hand. Packaged in a dispenser box.

Powdered

73005160	73005160	Small, 3 MIL	1000/cs.
73005170	73005170	Medium, 3 MIL	1000/cs.
73005180	73005180	Large, 3 MIL	1000/cs.
73005190	73005190	X-Large, 3 MIL	1000/cs.

Powder-Free

73005260	73005260	Small, 3 MIL	1000/cs.
73005270	73005270	Medium, 3 MIL	1000/cs.
73005280	73005280	Large, 3 MIL	1000/cs.
73005290	73005290	X-Large, 3 MIL	1000/cs.

HANDSOFF® SERIES GLOVES

B. HANDSOFF® GLOVES

PRIME SOURCE®

Household Helper® Latex Disposable Gloves

Cotton flock-lined latex gloves protect hands from household soaps and cleaners. Great for washing dishes, kitchen cleaning and handling household chemicals. Yellow.

75005800	75005800	Bulk	100/cs.
75005799	75005799	10 Per Bag	100/cs.

Office Helper® Vinyl Disposable Gloves

Powder-free vinyl gloves keep hands clean from messy office duties. Great for handling toner and ink cartridges.

75006300	75006300	Bulk	100/cs.
75006299	75006299	10 Per Bag	1000/cs.

Party Helper® Polyethylene Disposable Gloves

Powder-free gloves keep hands clean from party messes. Great for party preparation as well as serving food and clean-up.

75007200	75007200	Bulk	100/cs.
75007199	75007199	25 Per Bag	2500/cs.

Pet Helper® Polyethylene Disposable Gloves

Powder-free gloves keep hands clean from pet messes. Great for handling pet waste, cleaning animal cages and grooming. Sensi-pro.

75009000	75009000	Bulk	100/cs.
75008999	75008999	10 Per Bag	1000/cs.

Project Helper® Vinyl Disposable Gloves

Powder-free, vinyl gloves keep hands clean from messy household projects. Great for painting, staining and cleaning, as well as automotive care. Clear.

75006200	75006200	Bulk	100/cs.
75006199	75006199	10 Per Bag	1000/cs.

Helper® Pre-Loaded Clip Strips

Pre-loaded combo strip clip unit effectively displays Helper® line of gloves.

75006301	75006301	Pre-Loaded Clip Strips for Display	10/cs.
-----------------	----------	------------------------------------	--------

Helper® Retail Display Unit

Attractive point-of-purchase unit effectively displays Helper® line of gloves.

75005798	75005798	For Bagged Products	1/ea.
-----------------	----------	---------------------	-------



Disposable Gloves



NITRILE GLOVES

A. HANDSOFF® NITRILE DISPOSABLE GLOVES PRIME SOURCE®

High quality, single-use gloves. Protection against animal fats, oil-based solvents, petroleum, caustics and acids. 9 1/2" length with rolled cuff. Gloves fit either hand. Blue.

Lightly Powdered

75008310	75008310	X-Small, 5 MIL	1000/cs.
75008320	75008320	Small, 5 MIL	1000/cs.
75008330	75008330	Medium, 5 MIL	1000/cs.
75008340	75008340	Large, 5 MIL	1000/cs.
75008350	75008350	X-Large, 5 MIL	1000/cs.

Powder-Free

75008410	75008410	X-Small, 5 MIL	1000/cs.
75008420	75008420	Small, 5 MIL	1000/cs.
75008430	75008430	Medium, 5 MIL	1000/cs.
75008440	75008440	Large, 5 MIL	1000/cs.
75008450	75008450	X-Large, 5 MIL	1000/cs.



EXAM GLOVES

B. HANDSOFF® VINYL EXAM GLOVES PRIME SOURCE®

Provides better grip for instrument handling and greater comfort. Single-use gloves fit either hand and are packaged in a dispenser box. Clear.

Lightly Powdered

75006327	75006327	Small, 5 MIL	1000/cs.
75006337	75006337	Medium, 5 MIL	1000/cs.
75006347	75006347	Large, 5 MIL	1000/cs.
75006357	75006357	X-Large, 5 MIL	1000/cs.
75006655	75006655	2X-Large, 5 MIL	1000/cs.

Powder-Free

75006427	75006427	Small, 5 MIL	1000/cs.
75006431	75006431	Medium, 5 MIL	400/cs.
75006437	75006437	Medium, 5 MIL	1000/cs.
75006447	75006447	Large, 5 MIL	1000/cs.
75006457	75006457	X-Large, 5 MIL	1000/cs.



C. EAGLE EXAM GLOVES PRIME SOURCE®

Latex exam gloves. Beige.

Powdered

75005317	75005317	X-Small, 5 MIL	1000/cs.
75005327	75005327	Small, 5 MIL	1000/cs.
75005337	75005337	Medium, 5 MIL	1000/cs.
75005347	75005347	Large, 5 MIL	1000/cs.
75005357	75005357	X-Large, 5 MIL	1000/cs.

Powder-Free

75005417	75005417	X-Small, 5 MIL	1000/cs.
75005427	75005427	Small, 5 MIL	1000/cs.
75005437	75005437	Medium, 5 MIL	1000/cs.
75005447	75005447	Large, 5 MIL	1000/cs.
75005457	75005457	X-Large, 5 MIL	1000/cs.



D. HANDSOFF® EXAM GLOVES PRIME SOURCE®

Latex exam gloves. Clear.

Lightly Powdered

75005110	75005110	X-Small, 5 MIL	1000/cs.
75005120	75005120	Small, 5 MIL	1000/cs.
75005130	75005130	Medium, 5 MIL	1000/cs.
75005140	75005140	Large, 5 MIL	1000/cs.
75005150	75005150	X-Large, 5 MIL	1000/cs.

Powder-Free

75005210	75005210	X-Small, 5 MIL	1000/cs.
75005220	75005220	Small, 5 MIL	1000/cs.
75005230	75005230	Medium, 5 MIL	1000/cs.
75005240	75005240	Large, 5 MIL	1000/cs.
75005250	75005250	X-Large, 5 MIL	1000/cs.



Reusable Gloves/Bouffant Caps/Hairnets



REUSABLE GLOVES



A. HANDSOFF® REUSABLE FLOCK-LINED LATEX GLOVES

PRIME SOURCE®

Embossed 13" gauntlet with straight cuff. Soft cotton flock lining absorbs perspiration and comforts the hand. Not for medical use.

75005822	75005822	Small, Blue, 20 MIL	144/cs.
75005722	75005722	Small, Yellow, 20 MIL	144/cs.
75005832	75005832	Medium, Blue, 20 MIL	144/cs.
75005732	75005732	Medium, Yellow, 20 MIL	144/cs.
75005842	75005842	Large, Blue, 20 MIL	144/cs.
750057425	75005742	Large, Yellow, 20 MIL	12/cs.
75005742	75005742	Large, Yellow, 20 MIL	144/cs.
75005752	75005752	X-Large, Yellow, 20 MIL	144/cs.
75005852	75005852	X-Large, Blue, 20 MIL	144/cs.

General Purpose

75005710	75005710	X-Small, Yellow	144/cs.
750057205	75005720	Small, Yellow	12/cs.
75005720	75005720	Small, Yellow	144/cs.
750057305	75005730	Medium, Yellow	12/cs.
75005730	75005730	Medium, Yellow	144/cs.
750057405	75005740	Large, Yellow	12/cs.
75005740	75005740	Large, Yellow	144/cs.
750057505	75005750	X-Large, Yellow	12/cs.
75005750	75005750	X-Large, Yellow	144/cs.

BOUFFANT CAPS/HAIRNETS



B. PRIME SOURCE® BOUFFANT CAPS

PRIME SOURCE®

Latex-free caps that are comfortable and cool to wear.

Blue

75009242	75009242	18"	1000/cs.
75009244	75009244	21"	1000/cs.
75009246	75009246	24"	1000/cs.

Green

75009232	75009232	18"	1000/cs.
75009234	75009234	21"	1000/cs.
75009236	75009236	24"	1000/cs.

White

75009222	75009222	18"	1000/cs.
750092245	75009224	21"	100/cs.
75009224	75009224	21"	1000/cs.
750092265	75009226	24"	100/cs.
75009226	75009226	24"	1000/cs.
75009228	75009228	28"	1000/cs.

White/Pleated

75009252	75009252	18"	1000/cs.
75009254	75009254	21"	1000/cs.
75009256	75009256	24"	1000/cs.

C. PRIME SOURCE® HAIRNETS

PRIME SOURCE®

Easy to wear elastic fit. Regular size 1/8" honeycomb weave. 100 per pack.

75009202	75009202	18", White	1000/cs.
75009214	75009214	21", Brown	1000/cs.
75009204	75009204	21", White	1000/cs.
75009206	75009206	24", White	1000/cs.



Beard Guards/Dust Mask/Disposable Aprons



BEARD GUARDS

A. PRIME SOURCE® BEARD GUARDS PRIME SOURCE®

Full size and easy to wear. Elastic band keeps guard securely in place. Cloth-like, non-woven, lint free fabric and breathable fine mesh nylon. 100 per pack.

Nylon Mesh

75009267	75009267	18", Blue	1000/cs.
75009266	75009266	18", White	1000/cs.

Polypropylene

750092625	75009262	18", White	100/cs.
75009262	75009262	18", White	1000/cs.
75009264	75009264	21", White	500/cs.



B. PRIME SOURCE® POLY HOOD PRIME SOURCE®

A bouffant and beard guard all in one.

75009346	75009346	17", White	1000/cs.
----------	----------	------------	----------



DUST MASK

C. PRIME SOURCE® DUST MASK PRIME SOURCE®

Fiber-free and fluid resistant three-ply mask has pleated ear-loop design. Pleats add fullness for proper coverage. 99% bacterial efficiency.

75009341	75009341	One Size Fits All	600/cs.
----------	----------	-------------------	---------



DISPOSABLE APRONS/SMOCKS

D. PRIME SOURCE® POLYETHYLENE APRONS PRIME SOURCE®

Economical light-duty alternative.

Smooth Finish

75007249	75007249	24"W x 42"L, White, Bulk Pack, 1 MIL	1000/cs.
750072505	75007250	24"W x 42"L, White, Indiv. Pack, 1 MIL	100/cs.
75007250	75007250	24"W x 42"L, White, Indiv. Pack, 1 MIL	1000/cs.
75007270	75007270	28"W x 46"L, Blue, Bulk Pack, 1 MIL	500/cs.
75007242	75007242	28"W x 46"L, Blue, Bulk Pack, 1 MIL	1000/cs.
75007271	75007271	28"W x 46"L, Red, Bulk Pack, 1.5 MIL	500/cs.
750072435	75007243	28"W x 46"L, White, Bulk Pack, 1 MIL	100/cs.
75007243	75007243	28"W x 46"L, White, Bulk Pack, 1 MIL	1000/cs.
75007269	75007269	28"W x 46"L, White, Bulk Pack, 1.5 MIL	500/cs.
750072735	75007273	28"W x 46"L, White, Bulk Pack, 2 MIL	100/cs.
75007273	75007273	28"W x 46"L, White, Bulk Pack, 2 MIL	500/cs.
750072445	75007244	28"W x 46"L, White, Indiv. Pack, 1 MIL	100/cs.
75007244	75007244	28"W x 46"L, White, Indiv. Pack, 1 MIL	1000/cs.
750072685	75007268	28"W x 46"L, White, Indiv. Pack, 1.5 MIL	100/cs.
75007268	75007268	28"W x 46"L, White, Indiv. Pack, 1.5 MIL	500/cs.
75007248	75007248	28"W x 55"L, White, Bulk Pack, 1.5 MIL	500/cs.

Embossed Finish

75000089	75000089	28"W x 46"L, Blue, Bulk Pack, 1.5 MIL	500/cs.
75007275	75007275	28"W x 46"L, Blue, Bulk Pack, 1.5 MIL	500/cs.
75007239	75007239	28"W x 46"L, Clear, Bulk Pack, 1 MIL	1000/cs.
75007274	75007274	28"W x 46"L, Clear, Bulk Pack, 2 MIL	500/cs.
75007240	75007240	28"W x 46"L, Clear, Indiv. Pack, 1 MIL	1000/cs.
75007241	75007241	28"W x 46"L, Clear, Roll, 1 MIL	1000/cs.
75007246	75007246	28"W x 46"L, White, Bulk Pack, 1 MIL	1000/cs.
75007267	75007267	28"W x 46"L, White, Bulk Pack, 1.5 MIL	500/cs.
750072725	75007272	28"W x 46"L, White, Bulk Pack, 2 MIL	100/cs.
75007272	75007272	28"W x 46"L, White, Bulk Pack, 2 MIL	500/cs.
75007247	75007247	28"W x 46"L, White, Indiv. Pack, 1 MIL	1000/cs.
750072665	75007266	28"W x 46"L, White, Indiv. Pack, 1.5 MIL	100/cs.
75007266	75007266	28"W x 46"L, White, Indiv. Pack, 1.5 MIL	500/cs.
75007253	75007253	28"W x 56"L, White, Bulk Pack, 1 MIL	500/cs.
75007245	75007245	32"W x 52"L, White, 1.4 MIL	500/cs.
75007259	75007259	35"W x 60"L, White, Bulk Pack, 1.5 MIL	500/cs.



Disposable Aprons/Apron Gowns/Smocks



A - B

A. PRIME SOURCE® VINYL APRONS

PRIME SOURCE®

Extra protection from grease, oil and fat. Made of quality vinyl with nylon-serged edges and heat-sealed grommets.

Raw Edge

75007037	75007037	28" x 46", Blue, 1 MIL	1000/cs.
75007284	75007284	30" x 36", White, 8 MIL	72/cs.
750070015	75007001	35" x 45", Blue, 6 MIL	12/cs.
75007001	75007001	35" x 45", Blue, 6 MIL	72/cs.
76007001	76007001	35" x 45", Blue, 6 MIL	2500/cs.
750070285	75007028	35" x 45", White, 8 MIL	12/pk.
75007002	75007002	35" x 48", Blue, 6 MIL	72/cs.
76007002	76007002	35" x 48", Blue, 6 MIL	2500/cs.
75007003	75007003	35" x 50", Blue, 6 MIL	72/cs.
75007004	75007004	35" x 55", Blue, 6 MIL	72/cs.

Sewn Edge

75007006	75007006	35" x 45", Blue, 6 MIL	72/cs.
75007026	75007026	35" x 45", Blue, 8 MIL	72/cs.
75007007	75007007	35" x 48", Blue, 6 MIL	72/cs.
75007027	75007027	35" x 48", Blue, 8 MIL	72/cs.
75007035	75007035	35" x 48", White, 6 MIL	72/cs.
75007008	75007008	35" x 50", Blue, 6 MIL	72/cs.
75007009	75007009	35" x 55", Blue, 6 MIL	72/cs.
75007029	75007029	35" x 55", Blue, 8 MIL	72/cs.

Die-Cut

75007036	75007036	35" x 52", White, 8 MIL	72/cs.
----------	----------	-------------------------	--------

B. PRIME SOURCE® APRON GOWNS

PRIME SOURCE®

Embossed gown with elastic wrist. Individually wrapped. 4 MIL thickness.

75007279	75007279	X-Large, Blue	100/cs.
75007280	75007280	X-Large, Blue, Bulk	100/cs.
75007281	75007281	X-Large, White	100/cs.

C. PRIME SOURCE® DISPOSABLE SMOCKS

PRIME SOURCE®

Will not absorb moisture. Extremely durable and tear resistant. Reinforced neck band. Full-length elastic cuffed sleeves. Polyethylene coated. Standard length. White.

75009270	75009270	Small	100/cs.
75009271	75009271	Medium	100/cs.
75009272	75009272	Large	100/cs.
75009273	75009273	X-Large	100/cs.
75009278	75009278	X-Large, Short Sleeve	100/cs.
75009274	75009274	2X-Large	100/cs.
75009279	75009279	2X-Large, Short Sleeve	100/cs.
75009275	75009275	3X-Large	100/cs.
75009276	75009276	4X-Large	100/cs.
75009277	75009277	5X-Large	100/cs.

D. PRIME SOURCE® DISPOSABLE SMOCKS

PRIME SOURCE®

Extra long smocks will not absorb moisture. Extremely durable and tear resistant. Reinforced neck band. Full-length elastic cuffed sleeves. White.

75009280	75009280	Small	100/cs.
75009281	75009281	Medium	100/cs.
75009282	75009282	Large	100/cs.
75009283	75009283	X-Large	100/cs.
75009284	75009284	2X-Large	100/cs.
75009285	75009285	3X-Large	100/cs.



C



D

Disposable Sleeves/Oven Mitt/Work Gloves/Knee Pads



DISPOSABLE SLEEVES

A. PRIME SOURCE® POLYETHYLENE SLEEVES PRIME SOURCE®

Low cost waterproof protection for light-duty, limited-use applications. Heat-sealed with enclosed elastic at each end.

75007231	75007231	16", Blue	2000/cs.
75007221	75007221	16", White	2000/cs.
75007224	75007224	18", Blue	2000/cs.
75007223	75007223	18", White	2000/cs.



B. PRIME SOURCE® VINYL SLEEVES PRIME SOURCE®

Heat-sealed with enclosed elastic at the wrist and shoulder.

75007071	75007071	18", Blue, 6 MIL	144/cs.
75007081	75007081	18", Blue, 8 MIL	144/cs.
75007064	75007064	18", Clear, 4 MIL	144/cs.
75007084	75007084	18", Clear, 8 MIL	144/cs.
75007082	75007082	18", White, 8 MIL	144/cs.



OVEN MITT

C. PRIME SOURCE® OVEN MITT PRIME SOURCE®

Silicone treated oven mitt.

75000045	75000045	16"	72/pr.
----------	----------	-----	--------

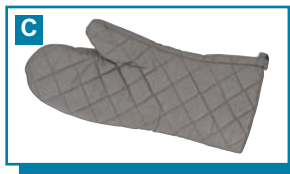

WORK GLOVES

D. PRIME SOURCE® KNIT WORK GLOVES PRIME SOURCE®

Grip dots on both sides.

75007509	75007509	Knit Work Gloves	240/cs.
----------	----------	------------------	---------



E. PRIME SOURCE® STRING KNIT GLOVES PRIME SOURCE®

Poly/cotton blend knitted gloves. Seven threads per inch. Bleached and unbleached with sewn wrist bands. Fits either hand.

75007501	75007501	Economy, Blue Wrist	480/cs.
75007507	75007507	Lightweight, White Wrist	480/cs.
750075035	75007503	Mediumweight, Green Wrist	12/cs.
75007503	75007503	Mediumweight, Green Wrist	480/cs.
75007505	75007505	Heavyweight, Gold Wrist	288/cs.



F. HEAVY-DUTY CLEANING/MAINTENANCE GLOVES RUBBERMAID

Designed for harsh applications and rough materials. Breathable stretch materials add to comfort. Knuckles padded with perforated Neoprene. Hook and loop fastener does not snag or collect debris. One hand strap adjustment. Red/Black.

17700045	9H00	Large	6/cs.
17700043	9H01	X-Large	6/cs.

KNEE PADS

G. I-GEL KNEE PADS RUBBERMAID

Non-marring cap protects surfaces. Non-skid cap helps to avoid slipping. I-Gel insert absorbs impact. Breathable perforated Neoprene material. Notched for comfort when standing. One-strap sizing plus opening for ventilation. Adjustable sizing pads on both sides.

17700047	9H10	4 1/4"H x 9"L x 7"W, Red/Black	6/cs.
----------	------	--------------------------------	-------



H. SWIVEL-FLEX KNEE PADS RUBBERMAID

Maneuverability with compact swivel cap. Flexible materials provide better fit and lasting comfort. Front strapping system fastens easily.

17700042	9H11	4 1/2"H x 10 1/2"L x 7 1/2"W, Red/Black	6/cs.
----------	------	---	-------





Lined writing area for notes.

Wipers



LIGHT-DUTY WIPERS

A. KIMTECH PURE® W4 DRY WIPERS KIMBERLY-CLARK

Solvent-resistant, binder-free, extra low-lint wipers. Low in particulate levels, ideal for class 100 cleanrooms. Wipes clean without scratching sensitive surfaces. Absorbent, soaks up to four times its weight in liquids. Anti-static packaging conforms to EIAS 541.

15403011 33330 12" x 12", 10/50 Flat Pack, White, 1-Ply 500/cs.



B. KIMTECH SCIENCE® KIMWIPES® DELICATE TASK WIPERS KIMBERLY-CLARK

A light-duty wiper that can handle a variety of delicate tasks. Easily wipes up liquid and dust. Anti-static dispensing reduces lint and electrostatic discharge, controls usage and portability reduces waste.

15407952 34256 140 ct., 14⁷/₁₀" x 16³/₅", White, Pop-Up® Box, 1-Ply 2100/cs.
 15407946 34133 196 ct., 11¹/₅" x 11⁴/₅", White, Pop-Up® Box, 1-Ply 2940/cs.
 15407948 34155 280 ct., 4²/₅" x 8²/₅", White, Pop-Up® Box, 1-Ply 16800/cs.
 15407942 34721 90 ct., 14⁷/₁₀" x 16³/₅", White, Pop-Up® Box, 2-Ply 1350/cs.



C. KLEENEX® HAND TOWELS KIMBERLY-CLARK

Hygienic, one-at-a-time dispensing from a Pop-Up® box. No more messy stacks of towels on your counter. Water-resistant coating on box to prevent box from getting wet. Meets EPA Standards of minimum 40% post-consumer waste content for towels.

15401701 01701 120 ct., 9" x 10¹/₂", White 2160/cs.



D. WYPALL® WIPERS KIMBERLY-CLARK

L10 Utility Wipers

Great for cleaning glass, wiping up spills, cleanup in light-duty manufacturing settings and general wiping tasks. Made with new absorbency pockets to help absorb more water faster.

15405320 05320 125 ct., 9" x 10¹/₂", White, Pop-Up® Box, 1-Ply 2250/cs.
 15405322 05322 125 ct., 12" x 10¹/₂", White, Pop-Up® Box, 1-Ply 2250/cs.
 15401770 01770 200 ct., 9¹/₅" x 10¹/₂", S-Fold, White, 1-Ply 2400/cs.

Economizer® L30 Wipers

Specifically designed to replace airlaid wipers, which have pool-prone pore areas. Ideal for a variety of light-duty maintenance, processing and janitorial wiping tasks.

15405812 05812 90 ct., 12¹/₂" x 14³/₅", White, 1/4 Fold 1080/cs.
 15405800 05800 100 ct., 16²/₅" x 9⁴/₅", White, Pop-Up® Box 800/cs.
 15400355 05816 120 ct., 16²/₅" x 9⁴/₅", White, Pop-Up® Box 720/cs.
 15400356 05820 300 ct., 9⁴/₅" x 15¹/₅", White, Center Pull Roll 600/cs.
 15405841 05841 950 ct., 12¹/₂" x 13³/₅", White, Jumbo Roll 1/ea.



MEDIUM-DUTY WIPERS

E. CHIX® FOODSERVICE TOWELS CHICOPEE

The preferred reusable foodservice towel which is washable, rinsable and absorbent for general wiping tasks.

25600167 8252 13¹/₂" x 21", White w/Red Logo 150/cs.
 25600170 8290 13¹/₂" x 24", White w/Red Logo 72/cs.

F. CHIX® PRO-QUAT™ FOODSERVICE TOWELS CHICOPEE

Sanitizer specific foodservice towels work with, not against, sanitizers. Extends the life of the sanitizing solution. Effectively releases sanitizer onto surface. Provides extra protection against cross-contamination. Solutions used with Chix® Professional Series towels remain consistently above 200 ppm for well over four hours when managed properly.

25600075 0075 13" x 21", Blue/Blue, Medium/Heavy-Duty 150/cs.
 25600066 0077 13" x 21", Red/Red, Medium/Heavy-Duty 150/cs.



G. FRESH GUY® CLOTH TOWELS CHICOPEE

Picks up food particles and grease. Dries faster to prevent odor build-up. Corrugated dispenser case.

25600169 8255 13¹/₂" x 21", Lemon Yellow 150/cs.



Wipers



A. SANIWORKS™ DELUXE FOODSERVICE TOWELS HOSPECO

Reduce the cost of terry towels and linen rental towels by at least 40%. This all purpose line of towels is functional for a wide range of applications including wiping tables and counters or washing pots and pans. Color-coded to avoid cross-contamination. Highly absorbent with exceptional strength. Convenient, protective packaging for inventory control.

14508796 MN8796 150 ct., 13" x 21", Blue 150/cs.



B. KIMTECH SCIENCE® PRECISION WIPES TISSUE WIPERS KIMBERLY-CLARK

An economical choice for general low-lint cleaning tasks. Soft and absorbent for general cleaning tasks. Anti-static dispensing reduces lint. Coated packaging helps protect wipes from spills.

15405515 05514 140 ct., 15" x 16¹/₈", White, Pop-Up® Box, 1-Ply 15/cs.



C. WYPALL® WIPERS KIMBERLY-CLARK

L20 Kimtowels® Wipers

New patented technology creates absorbency pockets to help absorb more water faster. Textured side for cleaning power. Contains no binders or glues. Multi-ply capacity for large spills.

15400364 47011 68 ct., 12¹/₂" x 14²/₅", Tan, 1/4 Fold 800/cs.

15407033 47033 88 ct., 9¹/₁₀" x 16¹/₅", Tan, Pop-Up® Box 880/cs.

15409960 58399 176 ct., 12¹/₂" x 16¹/₅", Tan, Brag® Box 176/cs.

L40 Wipers

Features our unique DRC (double re-creped) base sheet technology. This unique process produces a surface which is soft and cushiony and an inner layer for sponge like cells that absorb liquids efficiently. WypAll® L40 wipers are an outstanding general purpose wiper with good performance in a wide range of industrial cleaning and personal wiping tasks. Easily absorbs liquids, lubricants, and oils. Soft enough for use on face and hands.

15405776 05776 56 ct., 12¹/₂" x 14²/₅", Blue, 1/4 Fold 672/cs.

15400571 05701 56 ct., 12¹/₂" x 14²/₅", White, 1/4 Fold 1008/cs.

15405027 05027 70 ct., 11" x 10²/₅", White, Small Roll 1680/cs.

15404620 03046 90 ct., 10⁴/₅" x 10", White, Pop-Up® Box 9/cs.

15405741 05740 100 ct., 16²/₅" x 9¹/₅", Blue, Pop-Up® Box 900/cs.

15405790 05790 100 ct., 16²/₅" x 9¹/₅", White, Pop-Up® Box 900/cs.

15405796 05796 200 ct., 10" x 13¹/₅", White, Center Pull Roll 2/200/cs.

15405009 05007 750 ct., 12¹/₂" x 13³/₅", White, Jumbo Roll 750/rl.

Professional Towels

Towels are strong enough to wipe off equipment, yet soft enough for personal use. Ideal for health clubs, mining/manufacturing and schools.

15405770 05770 45 ct., 12" x 23", White, 1-Ply 540/cs.

X70 Foodservice Towels

Versatile and reusable. Ideal for all of your general cleaning needs. Strong yet soft cloth-like feel. Textured pattern helps trap and pick up food particles. Durable and machine washable. Rinses clean in sanitizing solution.

15402520 592520 300 ct., 12¹/₂" x 23¹/₂", White 300/cs.



HEAVY-DUTY WIPERS

D. CHIX® COMPETITIVE WET WIPES CHICOPEE

Non-woven, rayon-based. Can be used for one to two days. Wipes water-based liquids and debris. Rinsable and reusable. Packed in dispenser case.

25608507 8507 13¹/₂" x 24", Pink Diamond 200/cs.



E. TOUGHWORKS® 4-PLY SCRIM WIPERS HOSPECO

Strong, durable wipers made from multiple layers of tissue reinforced by a grid of cross-mesh scrim. Excellent wipe-dry capabilities and superior wet strength. Nylon reinforced for added strength. Low lint, ideal for smooth surfaces such as glass or stainless steel.

14509069 MC9069H 50 ct., 12" x 13", White, QF 900/cs.

14502302 MC2300H 150 ct., 9³/₄" x 17", White, IF 900/cs.

14502377 MC2375BH 9³/₄" x 275', Blue, Roll 6/cs.

14502378 MC2375H 9³/₄" x 275', White, Roll 6/cs.

Wipers



A. KIMTEX® SHOP TOWELS KIMBERLY-CLARK

A reusable, heavy-duty wiper for use with oils and solvents. Polypropylene construction for cloth-like feel and long-lasting performance. Low-lint cleaning performance, absorbs quickly for big cleanups.

15407060	33570	100 ct., 8 ¹ / ₂ " x 16 ¹ / ₂ ", Blue, Pop-Up® Box	500/cs.
15407997	33352	180 ct., 12 ¹ / ₁₀ " x 16 ¹ / ₂ ", Blue, Brag® Box	180/cs.



B. SCOTT® RAGS IN A BOX KIMBERLY-CLARK

Works like cloth, cloth-like feel. One-ply, strong absorbent wipes, wet or dry. For wiping, scrubbing, stain/paint and household cleaning. Lint-free, absorbs coatings, paints, and stains. Re-usable, washable.

15405260	75260	200 ct.	1600/cs.
-----------------	--------------	---------	----------



C. WYPALL® WIPERS KIMBERLY-CLARK

X50 Foodservice Towels

Versatile and reusable 1/4 fold towels are strong, yet soft. Made with Hydroknit® fast absorbing material for better cleaning performance.

15406053	06053	200 ct., 12 ¹ / ₂ " x 23 ¹ / ₂ ", White	200/cs.
-----------------	--------------	---	---------

X50 Wipers

Strong and sensible. Our most economical extended use wiper picks up where the competition falls apart. Combine versatile performance with economical design for light-duty tasks. Ideal for manufacturing, healthcare and transportation environments. At least 25% more sheets than leading competitor to tackle a variety of jobs. Reinforced for strength when wet or dry. Hydroknit® fabric eliminates adhesives and binders. Takes on airlaid, DRC and light-duty rags.

15403550	83550	9 ¹ / ₁₀ " x 12 ¹ / ₂ ", White	1760/cs.
-----------------	--------------	--	----------

X60 Teri® Reinforced Wipers

Reinforced wipers bring the absorbing power of Hydroknit® technology to a lighter weight wiper. Reinforced for extra scrubbing and cleaning power. Tough enough for big jobs but soft enough for face and hands.

15406550	34865	76 ct., 12 ¹ / ₂ " x 14 ² / ₅ ", White, 1/4 Fold	912/cs.
15409050	34790	126 ct., 9 ¹ / ₁₀ " x 16 ⁴ / ₅ ", White, Pop-Up® Box	1260/cs.
15401150	35411	130 ct., 9 ¹ / ₅ " x 13 ² / ₅ ", Blue, Small Roll	1560/cs.
15404015	34015	180 ct., 12 ¹ / ₂ " x 16 ¹ / ₂ ", White, Brag® Box	180/cs.
15404955	34955	1100 ct., 12 ¹ / ₂ " x 13 ² / ₅ ", White, Jumbo Roll	1/r.

X70 Workhorse® Manufactured Rags

Durable one-ply, absorbent rags that stay strong for better cleaning performance. Reusable, long-lasting performance. Cleans oil, grime and solvents with just one wipe. Made with high-tech Hydroknit® fast-absorbing material.

15400367	41200	76 ct., 12 ¹ / ₂ " x 14 ² / ₅ ", 1/4 Fold, White, 1-Ply	900/cs.
15400425	41200	76 ct., 12 ¹ / ₂ " x 14 ² / ₅ ", 1/4 Fold, White, 1-Ply	912/cs.
15404145	41455	100 ct., 9 ¹ / ₁₀ " x 16 ⁴ / ₅ ", White, Pop-Up® Box, 1-Ply	1000/cs.
15404130	41300	152 ct., 12 ¹ / ₂ " x 16 ¹ / ₂ ", White, Brag® Box, 1-Ply	152/cs.
15401702	41702	275 ct., 9 ¹ / ₅ " x 13 ² / ₅ ", Blue, Center Pull Roll, 1-Ply	3/cs.
15400366	41100	300 ct., 14 ⁹ / ₁₀ " x 16 ³ / ₅ ", White, Flat Sheet, 1-Ply	300/cs.
15404160	41600	870 ct., 12 ¹ / ₂ " x 13 ² / ₅ ", White, Jumbo Roll, 1-Ply	1/ea.

X80 Foodservice Towels

Versatile and reusable foodservice towels featuring Kimfresh® antimicrobial treatment. Strong yet soft towels are ideal for all general cleaning foodservice needs. Durable and machine washable. Rinse clean in sanitizing solution.

15406280	06280	150 ct., 12 ¹ / ₂ " x 23 ¹ / ₂ ", White/Blue Stripe, 1/4 Fold	150/cs.
-----------------	--------------	---	---------

X80 ShopPro® Shop Towels

Made using fast-absorbing Hydroknit® material. Engineered to feel like cloth. Delivers heavy-duty absorbency and strength in solvents.

15400346	41026	50 ct., 12 ¹ / ₂ " x 14 ² / ₅ ", White, 1/4 Fold	200/cs.
15401049	41048	80 ct., 9 ¹ / ₁₀ " x 16 ⁴ / ₅ ", White, Pop-Up® Box	400/cs.
15401041	41041	160 ct., 12 ¹ / ₂ " x 16 ¹ / ₂ ", Blue, Brag® Box	160/cs.
15401044	41044	160 ct., 12 ¹ / ₂ " x 16 ¹ / ₂ ", White, Brag® Box	160/cs.
15401043	41043	475 ct., 12 ¹ / ₂ " x 13 ² / ₅ ", Blue, Jumbo Roll	1/r.
15404105	41055	475 ct., 12 ¹ / ₂ " x 13 ² / ₅ ", Red, Jumbo Roll	1/r.
15401025	41025	475 ct., 12 ¹ / ₂ " x 13 ² / ₅ ", White, Jumbo Roll	1/r.



Wipers/Cleaning Wipes



A. DUBL-TOUGH® INDUSTRIAL WIPERS WAUSAU PAPER/BAY WEST

Ultra DUBL-Tough wiper is double crepe (DRC) for your most important tasks. The DRC wiper is perfect for absorbing liquids and leaves surfaces streak-free.
30033380 03380 50 ct., 12¹/₄" x 13", 1/4 Fold 1000/cs.



B. ULTRAWIPES ZEP

Strong, re-usable, lint-free wiper. This solvent-resistant non-woven cloth is excellent for glass, chrome, metal, and vinyl surfaces. Use again and again for hands, tools, and equipment. Use wet or dry.
75070146 895601 Blue 450/cs.



C. INTERSTATE® AUTO CARE WIPERS GEORGIA-PACIFIC

Paper Wipers
 Economical, one-ply blue windshield and auto care disposable towels.
13701235 02350 188 ct., 9¹/₂" x 10¹/₄", Blue, 1-Ply 2250/cs.

Singlefold Auto Care Paper Wipers
 Premium, two-ply blue windshield and auto care disposable paper towels. Replaces 29390 when depleted. Provides streak-free cleaning ideal for automotive windshields, mirrors and more. Blue color stays cleaner looking and provides for extended use to help reduce costs. Popular, space-saving, moisture-resistant poly case helps protect the product.
13700702 00350 188 ct., 9¹/₂" x 10¹/₄", Blue, 2-Ply 2250/cs.



D. WYPALL® L10 WINDSHIELD TOWELS KIMBERLY-CLARK

Improved for better cleaning performance. Extra strength and special textured surface.
15405123 05123 224 ct., 9¹/₁₀" x 10¹/₄", Blue, 1-Ply 10/224/cs.
15405120 05120 140 ct., 9¹/₈" x 10¹/₂", Blue, 2-Ply 16/140/cs.



E. TORK® UNIVERSAL WINDSHIELD TOWELS SCA TISSUE

Soft, absorbent and strong windshield towels provide maximum absorption in a variety of climates and conditions. Singlefold design fits all the standard dispensers. Contains 100% recycled fibers.
14102121 192121 250 ct., 9¹/₈" x 10¹/₄", Blue, 1-Ply 2250/cs.



F. CLOROX® COMMERCIAL SOLUTIONS® GERMICIDAL WIPES CLOROX

Effective against a wide range of microorganisms and engineered to meet the disinfecting needs of today's busy healthcare professionals. Provides real-world kill and contact times, convenient application methods and a one-year shelf-stable, bleach-based formula. One minute contact kills Rotavirus, E. coli, Staphylococcus aureus, and HIV Type 1. Contains 1:10 bleach solution recommended by the CDC in a ready-to-use formula.
38385309 35309 70 ct. 420/cs.



G. CLOROX® GERMICIDAL WIPES CLOROX

Effective against a wide range of microorganisms and engineered to meet the disinfecting needs of today's busy healthcare professionals. Provides real-world kill and contact times, convenient application methods and a one-year shelf-stable, bleach-based formula. Ready-to-use, hospital-grade disinfectant. Kill claims for over 30 different microorganisms, including MRSA, HIV Type 1, Pseudomonas aeruginosa, Staphylococcus aureus, Streptococcus pyogenes, Streptococcus pneumoniae and Acinetobacter baumannii. Contact time of 30 seconds for most bacteria (see product label). Contains the power of Clorox® bleach.
38380032 30358 110 ct. 220/cs.
38380031 30359 110 ct., Refill 220/cs.

WINDSHIELD WIPERS

CLEANING WIPES

Cleaning Wipes



A. CLOROX® DISINFECTING WIPES CLOROX

The quick and easy way to clean and disinfect anytime and anywhere. Pre-moistened with cleaners and disinfectants, these handy household wipes are ready-to-use. Just wipe, toss, and you're done. Bleach-free formula kills 99.9% of bacteria, including Staph and Salmonella. Ideal for day care centers, offices, schools and restaurants.

38381593	01593	35 ct., Fresh Scent	12/cs.
38381594	01594	35 ct., Lemon Scent	12/cs.
38385949	15949	75 ct., Fresh Scent	6/cs.
38385948	15948	75 ct., Lemon Scent	450/cs.
38381686	01686	75 ct., Orange Scent	6/75/cs.
To-Go Travel Pack			
38381665	01665	9 ct., Travel Pack	24/cs.



B. GREEN WORKS® CLEANING WIPES CLOROX

The biodegradable plant and mineral base ingredients work as well as traditional cleaners to cut through filmy residue. Contains no phosphorus or bleach. Works on glass, mirrors, appliances, stainless steel and sealed granite. Essential lemon oil scent.

38380380	30380	62 ct.	384/cs.
-----------------	-------	--------	---------



C. FABULOSO® ALL PURPOSE WIPES COLGATE-PALMOLIVE

Premoistened multi-use wipes. Effective for a wide variety of cleaning applications. Powerful commercial-strength formula. Safe for use on stainless steel, tubs, sinks, chrome, porcelain, doors, tables and washable walls.

11903039	53039	100 ct., 7" x 8", Lavender	600/cs.
-----------------	-------	----------------------------	---------



D. MURPHY® OIL SOAP WIPES COLGATE-PALMOLIVE

Safely and easily removes dust, dirt and grime. No dulling residue. Ideal for cleaning wood furniture, kitchen cabinets and tables, doors and wood trim. Does not contain any chemicals or solvents that are harmful to wood surfaces. Cleans away wax build-up. Handy resealable pouch.

11905901	25901	18 ct.	216/cs.
-----------------	-------	--------	---------



E. WETTASK® WIPERS KIMBERLY-CLARK

The WetTask® refillable wet wiping system is ideal for critical tasks in healthcare and clean manufacturing environments. Use as an alternative to using a spray bottle or open bucket in combination with a rag. Combines all steps into one. Choose the wiper that works best for your task.

15406212	06211	90 ct., 12" x 12 1/2", White	540/cs.
-----------------	-------	------------------------------	---------



F. LYSOL® BRAND I.C.™ DISINFECTANT WIPES RECKITT BENCKISER

Tuberculocidal, virucidal, bactericidal and pseudomonocidal. Cleans, disinfects and deodorizes. Hospital disinfectant in a convenient, disposable wipe. Meets the decontamination requirements of the OSHA Bloodborne Pathogens Standard. Bleach-free. Alcohol-free.

58342700	80027	160 ct.	960/cs.
-----------------	-------	---------	---------



G. LYSOL® DISINFECTING WIPES RECKITT BENCKISER

One-step cleaning and disinfecting in a premoistened towelette. Kills 99.9% of germs on hard, non-porous surfaces in 30 seconds. Packaged in convenient canisters. Air-tight canister package keeps wipes moist and effective, allows reclosure with wipe partially threaded. Disinfects and deodorizes in one easy wipe.

58348114	81145	35 ct., Citrus	420/cs.
58341146	81146	35 ct., Spring Waterfall	420/cs.
58347182	77182	80 ct., Citrus	6/cs.
58347925	77925	80 ct., Spring Waterfall	6/cs.
58344906	78849	110 ct., Citrus	6/cs.



H. LYSOL® DUAL ACTION DISINFECTING WIPES RECKITT BENCKISER

Dual action wipes have a scrubbing side that removes tough messes and a wiping side that kills 99.9% viruses and bacteria.

58341700	81700	56 ct., Citrus	6/cs.
-----------------	-------	----------------	-------



Cleaning Wipes/Sponges/Scrubbers



A. SANI-WIPE® NO-RINSE SURFACE SANITIZING WIPES **SANI PROFESSIONAL**
 FDA Food Code compliant formula for use on surfaces that come in contact with food. Tested and proven to kill E. coli, Staph and Shigella boydii on food contact surfaces in 60 seconds. Excellent for sanitizing hard, non-porous surfaces.
49684384 Q94384 100 ct., 7³/₄" x 10¹/₂" 6/cs.



B. SAFETY TOWELS **SIMPLE GREEN**
 Pre-moistened with non-toxic and biodegradable Crystal Simple Green. Designed with the industrial cleaning strength of Crystal Simple Green infused into thermally bonded, dual textured, lint-free polypropylene towels. These towels also have an excellent wicking/fluid holding capacity, are highly resistant to rot and mildew and have an abrasive side for tough scrubbing.
73430002 13351 75 ct., 10" x 11³/₄" 450/cs.



C. PRE-MOISTENED GENERAL PURPOSE CLEANING TOWELS **ZEP**
 Heavy-duty towels with citrus cleaning power. Ideal for general purpose cleaning on a wide range of surfaces. Towels absorb surface soils. Fresh orange fragrance.
75070137 R09201 72 ct. 6/cs.

SPONGES/SCRUBBER SPONGES



D. CELLULOSE SPONGE **PRIME SOURCE®**
 Large cellulose block sponge.
75004164 75004164 3³/₈" x 6¹/₄" x 1" 48/cs.



E. CONTOUR™ SPONGE N' SCRUBBER **PRIME SOURCE®**
 Blue non-scratch cleaning pad. Treated with Ultra-Fresh®, an antimicrobial treatment protecting from odors and fungal growth. Scratch-resistant scrubbing sponge.
75004168 75004168 Blue 20/cs.

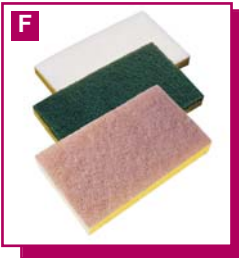

F. SCRUBBING SPONGES **PRIME SOURCE®**
Regular
 Regular-duty scouring pad and cellulose sponge combination. Excellent for counter tops, wall switch plates and around door knobs. Use in combination with cleaning solutions for faster action.
75004166 75004166 3⁷/₁₆" x 6¹/₁₆" 40/cs.



Walnut
 An innovative cleaning pad with organic crushed walnut shells. Walnut is a natural abrasive that provides aggressive cleaning action for virtually any surface. Use on ceramic, porcelain, stainless steel, painted surfaces, and more. Open web design and heavy thickness of the pad ensures its resiliency through hundreds of uses.
75004167 75004167 3⁷/₁₆" x 6¹/₁₆", Walnut 20/cs.



G. NIAGARA™ MEDIUM-DUTY SCRUB SPONGE 74N **3M**
 A dual action, medium-duty cleaning pad/sponge for most common cleaning jobs. Typical applications; walls, tables, fixtures, countertops, floors.
66551074 04801119428 6¹/₁₀" x 3³/₈", Yellow/Green 20/cs.



H. SCOTCH-BRITE™ LIGHT-DUTY SCRUB SPONGE 63 **3M**
 Light-duty cleaning pad/sponge won't scratch or mar most surfaces. Typical applications: Stainless steel, glass, ceramic, fine china, porcelain, countertops and non-stick surfaces.
66556303 04801108251 3.6" x 6.1" x .07", Yellow/White 20/cs.

I. SCOTCH-BRITE™ MEDIUM-DUTY SCRUB SPONGE 74 **3M**
 Dual-action cleaning tool. Scouring pad on one side for scrubbing and cleaning and cellulose sponge on the other side to wipe up spills and messes and carry cleaning solutions.
66550744 04801120688 3.6" x 6.1" x .07", Green/Yellow 20/cs.

Scrubbers/Scouring Pads



A. SCOUR SPONGE CCP

Excellent for spot cleaning and general scrubbing.
27600951 14 6 1/4" x 3 3/8" x 7/8", Yellow/Green 40/cs.



B. SCRUBBING SPONGES CCP

Utility cellulose sponge with medium-duty scouring pad attached. Cellulose sponge absorbs water while the green abrasive pad helps cleaners work even better. Works well on sinks, countertops, tables, walls, pots and pans. Rinses clean easily.

27600439 20944 3 7/16" x 6 1/4" 40/cs.
27600940 20946 3 7/16" x 6 1/4" 40/cs.



C. SPONGE N' SCRUBBER CCP

Utility cellulose sponge with medium-duty scouring pad attached. Cellulose sponge absorbs water while the green abrasive pad helps cleaners work even better. Works well on sinks, countertops, tables, pots and pans. Rinses clean easily. Treated with Ultra-Fresh.

27600773 SS652 3 7/16" x 6 1/4", Yellow/Green 40/cs.



D. S.O.S.® SCRUBBER SPONGE CLOROX

Effective against tough jobs, but easy on surfaces. Patented easy-to-hold shape.
38381251 91028 3-Pack, All-Surface 24/cs.

E. MR. CLEAN® MAGIC ERASER PADS PROCTER & GAMBLE

Cleaning Wiping Pads

A disposable, soft cleaning pad that acts just like an eraser with water alone. No fumes, gloves or chemicals required. It removes scuff marks and dirt from floors, walls and doors. Even removes tough crayon marks.

16903516 43516 4 ct., White 24/cs.

Duo Cleaning Wiping Pads

White side cleans tough soils, blue side wipes up everyday messes. White side acts like an eraser that breaks up dirt and lifts it away from surface. Blue side is an absorbent layer that helps you hold on to eraser.

16907700 01278 4 ct., Blue/White 24/cs.



SCOURING PADS

F. SCOURING PADS PRIME SOURCE®

Medium-duty scouring pads are ideal for cleaning equipment and removing grime from surfaces. Heavy-duty scouring pads are ideal for the toughest cleaning jobs.

750041615 75004161 6" x 9", Medium-Duty 10/pk.
75004161 75004161 6" x 9", Medium-Duty 60/cs.
750041605 75004160 6" x 9", Heavy-Duty 10/bx.
75004160 75004160 6" x 9", Heavy-Duty 60/cs.



G. ULTRA DUTY POT & PAN SCOURING PAD PRIME SOURCE®

Easily removes the most stubborn, baked-on deposits from pots and pans. Replaces scrapers and metal sponges for tough cleaning jobs.

75004163 75004163 3 1/2" x 5", Dark Green 36/cs.



H. WALNUT SCOURING PAD PRIME SOURCE®

Scratch-resistant scouring pads for cleaning delicate items.

75004162 75004162 6" x 9", Walnut 60/cs.



I. SCOTCH-BRITE™ HEAVY-DUTY SCOUR PAD 86 3M

Open construction pad with tough fibers and abrasives make fast work of heavy-duty cleaning jobs. Use in the kitchen to replace scrapers, steel wool and metal sponges. Typical applications include heavily baked-on food and food processing equipment.

66558600 04801105509 6" x 9", Green 36/cs.



J. SCOTCH-BRITE™ POT 'N PAN SCOUR PAD 88 3M

Thick, open mesh construction. Rinses out easily, doesn't splinter and won't rust. Can replace stainless steel scrubbers. More effective than most pot scrubbing pads. Ideal for cleaning stubborn cheeses and thick sauce deposits on pots and pans.

66558800 04801108292 3 1/2" x 5", Blue 40/cs.

Scouring Pads/Utility Pads



A. SCOTCH-BRITE™ GENERAL PURPOSE SCOUR PAD 96 3M

The original synthetic scouring pad is long lasting, non-rusting and resilient. Use it for everyday cleaning of most cooking utensils and equipment.

66559600 04801108293 6" x 9", Green 60/cs.



B. NIAGARA™ MEDIUM-DUTY HAND PAD 96N 3M

The original synthetic scouring pad and is still the performance leader. Ideal for most common cleaning jobs.

66559696 04801118196 6" x 9", Green, Cash n' Carry 60/cs.



C. SCOTCH-BRITE™ PURPLE PAD 3M

Combines tough coiled fibers with a high-scouring, low-scratching abrasive to cut through messes twice as fast as conventional heavy-duty scouring pads with up to 11 times fewer scratches. Open web construction allows food debris to easily rinse out. Up to 10 times more durable than conventional medium-duty scour pads. A great replacement for stainless steel and steel wool. Can be used wet or dry.

66552020 70071311750 4 1/2" x 2 1/5" 24/cs.



D. JIF-Y-CLEAN™ 49A SCOURING PAD CCP

Light-duty white cleaning pad. Non-abrasive for light clean-up jobs on ceramic, porcelain, stainless steel, and painted surfaces.

27600078 20948 6" x 9", White 60/cs.



E. MEDIUM-DUTY SCOURING PADS CCP

Medium-duty green scouring and cleaning pad for areas where aggressive cleaning is required.

27600447 20942 6" x 9", Green 20/cs.

27600942 20940 6" x 9", Green, 96A 60/cs.

27600522 20941 6" x 9", Green, 96B 60/cs.



F. MEDIUM-DUTY SCOURING PAD CCP

A general purpose cleaning pad, designed for daily cleaning of pots, pans, utensils, equipment and floors. Great for cleaning fresh vegetables. Not recommended for use on certain soft plastics, fine china or polished steel.

27600835 MD6920 6" x 9", Green 20/cs.



G. HEAVY-DUTY SCOURING PAD CCP

Use where heavy aggressive action is required. Attach to mop for removing scuff marks off tile floors. Ideal for grimy maintenance equipment.

27601086 20954 6" x 9", Green 60/cs.



H. HEAVY-DUTY SCOURING PAD CCP

Very abrasive pad. Effective for removing heavy baked-on deposits, such as rust and corrosive deposits from metal surfaces. Ideal for hard-to-clean utensils and scuff marks on floors.

27600184 HD69 6" x 9", Dark Green 60/cs.



I. WALNUT PAD™ SCOURING PAD CCP

Scratch-resistant with aggressive cleaning action. Safe to use on polished stainless steel, ceramic, copper, porcelain and painted surfaces. Contains organic crushed walnut shells.

27600452 29514 6" x 9" 20/cs.



J. KLEENFAST HEAVY-DUTY PAD PRIME SOURCE®

For heavy-soiled traffic areas such as halls, stairs around stoves and fryers. Easily removes old finish and wax build-up.

750044675 75004467 4 1/2" x 10", Brown 5/bx.

75004467 75004467 4 1/2" x 10", Brown 20/cs.

UTILITY PADS/HOLDERS

Utility Pads/holders/Steel Wool & SS Pads



A. KLEENFAST SWIVEL HOLDER KIT PRIME SOURCE®

For heavy-soiled traffic areas such as halls, stairs around stoves and fryers. Easily removes old finish and wax build-up.

750044681	75004468	4 1/2" x 10", Includes (1) Holder & (2) Pads	1/ea.
75004468	75004468	4 1/2" x 10", Includes (1) Holder & (2) Pads	4/cs.



B. 3M™ DOODLEBUG™ SCRUB' N STRIP PADS 8541 3M

Designed for tough jobs like removing finish and wax build-up from baseboards and floor edges. A great way to strip stairs.

66558541	04801108004	4 5/8" x 10", Brown	20/cs.
----------	-------------	---------------------	--------



C. KLEENFAST® UTILITY PADS CCP

A convenient, integrated system that combines holders and different pads to handle a variety of cleaning tasks.

27600460	20968	4 1/2" x 10", White, Light-Duty	20/cs.
27602508	22508	4 1/2" x 10", Black, Heavy-Duty	20/cs.
27600969	20969	4 1/2" x 10", Brown, Heavy-Duty	20/cs.



STEEL WOOL PADS

D. BRILLO® STEEL WOOL SOAP PADS CCP

Hotel size soap pads for heavy-duty cleaning of pots and pans. The special combination of metal fiber and soap dissolves stubborn grease and lifts off sticky food particles leaving a bright new shine.

27600020	29404	4" x 4", Boxed	120/cs.
----------	-------	----------------	---------



E. SOAP PADS CCP

Made of fine steel wool formed into large hotel size soap impregnated pad. Dissolves stubborn grease and lifts off sticky food particles. Not recommended for soft plastics or fine china.

27601210	SP1210	Soap Pads	120/cs.
----------	--------	-----------	---------



F. S.O.S.® SOAP PADS CLOROX

Steel wool plus soap. Cuts grease and shines metal. Extra thick pad with more soap. Pad contains rust inhibitors.

38388320	88320	15 ct.	180/cs.
----------	-------	--------	---------



STAINLESS STEEL SCRUBBERS

G. POT SCRUBBERS PRIME SOURCE®

Stainless steel pot scrubbers.

750042905	75004290	35 g	12/cs.
75004290	75004290	35 g	72/cs.
75004292	75004292	43 g	72/cs.
750042915	75004291	50 g	12/cs.
75004291	75004291	50 g	72/cs.



H. SCOTCH-BRITE™ STAINLESS STEEL SCRUBBER 3M

High quality stainless for tough cleaning chores, won't rust or splinter. Removes baked-on food from pots/pans, baking dishes, grills and ovens.

66550884	04801119084	1 3/4 oz.	12/cs.
----------	-------------	-----------	--------



I. 400 SERIES STAINLESS STEEL SCRUBBERS CCP

Manufactured from less expensive 400 series wire construction. This scrubber has effective properties for the removal of baked-on deposits and other medium-duty jobs.

27602204	D204	35 g	72/cs.
276007885	D104	50 g	12/cs.
27600788	D104	50 g	72/cs.



CLEANING TOOLS

Grill Care/Scrub Brushes



GRIDDLE/GRILL CARE

A. GRIDDLE PAD PRIME SOURCE®

Griddle pad will do light cleaning and polish the grill surface to bring back shine. Griddle pad must be used with a griddle screen and holder. Pad allows articles from grill to soak up through the screen and prevents clogging.

750041655	75004165	4" x 5 1/2", Black	10/pk.
75004165	75004165	4" x 5 1/2", Black	500/cs.

B. SCOTCH-BRITE™ GRIDDLE POLISHING PAD 46 3M

Use between screen and holder to maximize screen life and minimize loading. Strong nylon web construction contains hard working abrasive for additional cleaning power.

66554802	04801120508	4" x 5 1/4", Cash n' Carry	60/cs.
----------	-------------	----------------------------	--------

C. SCOTCH-BRITE™ HEAVY-DUTY GRIDDLE CLEANING PAD 82 3M

Heavy-duty griddle cleaning pad with open web construction for the toughest jobs. Removes heavily burned-on food and grease to provide a spotless, shiny griddle in minutes.

66550049	04801108299	4 1/2" x 5 1/2"	4/cs.
----------	-------------	-----------------	-------

D. GRIDDLE PAD CCP

When used alone on a warm grill, this pad will do light cleaning and polish the grill surface to bring back the shine. A griddle pad must be used when using a griddle screen and holder. The pad allows particles from the grill to soak up through the screen and prevents the screen from clogging.

27600813	GP46	4" x 5 1/2"	60/cs.
----------	------	-------------	--------

E. GRIDDLE PAD HOLDER CCP

Uniquely designed, manufactured from high heat-resistant plastic to protect hands from grease and burns. The gripping teeth hold the griddle pad firmly in place.

27600022	GPH10HR	Griddle Pad Holder	10/cs.
----------	---------	--------------------	--------

F. GRIDDLE SCREENS CCP

Use griddle screens for those times when you do not need to clean a heavily charred grill or for use after cleaning with a Grillbrick®. For more effective cleaning, use the griddle screen with a griddle pad. Grill should be 212° or less. The pad allows the particles from the grill to soak up through the griddle screen and will help keep the screen from clogging. Choose any of our griddle pad holders to protect hands from grease and burns. Made in USA.

27600238	GS1020	4" x 5 1/2", Black	200/cs.
27600242	G35	4" x 5 1/2", Black	400/cs.

G. GRILBRIK® GRILL BRICK CCP

Use safely on hot griddles without lifting griddle cure. Easy to use and cost effective. Film wrap acts as the holder. Virtually odor-free.

27601613	GB12	8" x 4" x 3 1/2"	12/cs.
----------	------	------------------	--------

GENERAL PURPOSE/SCRUB BRUSHES

H. UTILITY SCRUB BRUSH PRIME SOURCE®

Grips and bristles are designed to work in the most comfortable position and provide the most efficient cleaning. 2" trim.

75004918	75004918	8", Plastic Block w/Tampico Bristles	12/cs.
----------	----------	--------------------------------------	--------

I. TOUGH SCRUB™ UTILITY SCRUB W/HANDLE CCP

Nylon fill outlasts ordinary fibers and is bacteria and heat-resistant. Ideal for kitchen scrubbing and other tough jobs. Fibers are flared to get into tight places and clean quickly. White plastic block is virtually unbreakable.

276022081	1502208	8 1/2" x 2" Trim	1/ea.
-----------	---------	------------------	-------

Counter, Bowl, Automotive & Deck Brushes



COUNTER/BENCH BRUSHES

A. COUNTER BRUSHES

PRIME SOURCE®

Counter brushes are ideal for removing fine particles.

75004923	75004923	8", Plastic Bristles, Black	12/cs.
750098601	75009860	8", Polypropylene Bristles	1/ea.
75004924	75004924	8", Tampico Bristles	12/cs.

B. DUSTING BRUSH W/HANDLE

PRIME SOURCE®

The flagged tips of this bristle make this the ideal tool for fine dust and dirt retention on smooth surfaces. It is great for shops, light industrial and commercial uses.

750049601	75004960	8", Gray, Structural Foam/Polystyrene	1/ea.
75004960	75004960	8", Gray, Structural Foam/Polystyrene	12/cs.

BOWL BRUSHES

C. BOWL BRUSH

PRIME SOURCE®

Properly designed brush for sanitary cleaning of toilet bowls makes the cleaning chore faster and easier.

75004917	75004917	15", White, Tampico	24/cs.
----------	----------	---------------------	--------

D. ECONOMY BOWL MOPS

PRIME SOURCE®

Economical bowl mop with colorful plastic handle has a fast-drying, non-absorbent acrylic yarn puff to gently wash porcelain fixtures.

750049611	75004961	12", White, Acrylic	1/ea.
75004961	75004961	12", White, Acrylic	144/cs.
750098611	75009861	12", White, Nylon	1/ea.

E. ECONOMY BOWL MOP

CCP

Economical bowl mop with plastic handle has a fast-drying, non-absorbent acrylic yarn puff to gently wash porcelain fixtures.

276051151	J510000	12", White	1/ea.
-----------	---------	------------	-------

F. TOILET BOWL BRUSH

CCP

Toilet bowl brush.

27607017	CJ507017	18"	12/cs.
----------	----------	-----	--------

G. TOILET BOWL BRUSH

RUBBERMAID

Synthetic polypropylene bristles resist stains and odors.

177063101	6310	14 1/2", White, Plastic Handle	1/ea.
17706310	6310	14 1/2", White, Plastic Handle	24/cs.

AUTOMOTIVE BRUSHES

H. DUAL SURFACE® FLO-THRU WASH BRUSH

PRIME SOURCE®

Dual Surface® block design keeps the bristles working at almost every angle.

75004777	75004777	Flo-Thru Wash Brush	12/cs.
----------	----------	---------------------	--------

I. FLO-THRU FLAGGED VEHICLE WASH BRUSH

PRIME SOURCE®

Vehicle wash brush has a flo-thru design that insures a constant flow of water with polystyrene bristles and vinyl bumper.

75004757	75004757	10"	12/cs.
----------	----------	-----	--------

DECK BRUSHES

J. DUAL SURFACE® FLOOR BRUSH

PRIME SOURCE®

Features three surfaces and end bristles for efficiently cleaning flat surfaces, in and around corners and along baseboards and corners.

750047151	75004715	10", Blue, Plastic Block w/PPY Bristles	1/ea.
75004715	75004715	10", Blue, Plastic Block w/PPY Bristles	6/cs.



Deck Brushes/Corn Brooms



A. SWIVEL SCRUB® DECK BRUSH PRIME SOURCE®

Swivel Scrub® for heavy scrubbing of built-up floor finish in tight areas and baseboards. Excellent for hard-to-reach areas.

750049191	75004919	8", Plastic Block w/PPY Bristles	1/ea.
75004919	75004919	8", Plastic Block w/PPY Bristles	4/cs.



B. FLOOR SCRUB RUBBERMAID

Plastic block with bi-level polypropylene fill.

17700869	6337	10", Blue	6/cs.
----------	------	-----------	-------

CORN BROOMS

C. CLEAN SWEEP™ BROOMS PRIME SOURCE®

Wisk Brooms

Features double-stitched, nylon cord bound fibers that are wrapped onto wood handle with hang cap. Designed for long life and efficient sweeping.

75004906	75004906	Black Stitch, 2-Stitch, Blend	12/cs.
750098061	75009806	10"	1/ea.

Toy Broom

Toy corn blend broom.

75004907	75004907	Corn Blend	12/cs.
----------	----------	------------	--------

Fan Maid Broom

High quality blend corn broom. Durable upright broom designed for long life and efficient sweeping. Four stitches. 7/8" dia. wood handle.

750049011	75004901	18#, Corn Blend	1/ea.
75004901	75004901	18#, Corn Blend	6/cs.

Lobby Brooms

100% corn broom.

75004905	75004905	34"	12/cs.
750049051	75004905	34", Red Handle	1/ea.
750098051	75009805	34"	1/ea.

Warehouse Brooms

Six rows of stitching and metal band.

750049021	75004902	28#, Corn Blend	1/ea.
75004902	75004902	28#, Corn Blend	6/cs.
750049031	75004903	32#, Corn Blend	1/ea.
75004903	75004903	32#, Corn Blend	6/cs.
75004904	75004904	32#, Blend	6/cs.

Janitor Broom

Janitor broom with five rows. Use for industrial and janitorial sweeping.

276006811	91522	Natural Blend	1/ea.
-----------	-------	---------------	-------



D. NATURAL CORN BROOMS PRIME SOURCE®

100% natural corn blend brooms. High bristle fill count for excellent durability and value.

750098011	75009801	Housekeeping Broom - 4 Sew, 55"	1/ea.
75009801	75009801	Housekeeping Broom - 4 Sew, 55"	12/cs.
750098041	75009804	Janitor Broom - 5 Sew, 56"	1/ea.
75009804	75009804	Janitor Broom - 5 Sew, 56"	12/cs.
750098071	75009807	Lobby Broom, 40"	1/ea.
75009807	75009807	Lobby Broom, 40"	12/cs.



E. LOBBY PRO® LOBBY CORN BROOM RUBBERMAID

100% corn broom.

177007251	6373	Corn	1/ea.
17700725	6373	Corn	12/cs.



F. CORN BROOM RUBBERMAID

Designed for rugged indoor/outdoor cleaning. 100% natural broom corn fibers for long life and effective pick-up. Remove fine dirt from even or rough surfaces. Hand-selected, heavy-duty lacquered pine handle.

177063811	6381	24#, Standard, Red	1/ea.
-----------	------	--------------------	-------

Poly/Angle Brooms



POLY/ANGLE BROOMS

A. ANGLE SWEEP™ ANGLE BROOMS

PRIME SOURCE®

Flagged angle broom complete.

750049101	75004910	10", Small	1/ea.
75004910	75004910	10", Small	12/cs.
750049111	75004911	12", Large	1/ea.
75004911	75004911	12", Large	12/cs.



B. DUO-SWEEP® ANGLE BROOMS

PRIME SOURCE®

No hood/shroud to break or gather soils leading to cross-contamination issues. Excellent balance to reduce sweeping fatigue. Two handle holes; one upright, one angled. Item 75009811 and 75009812 come equipped with wood handles.

750098111	75009811	Flagged Angle Broom	1/ea.
75009811	75009811	Flagged Angle Broom	12/cs.
750098121	75009812	Unflagged Angle Broom	1/ea.
75009812	75009812	Unflagged Angle Broom	12/cs.



C. ANGLE SWEEP™ ANGLE BROOM

CCP

Angle broom with a plastic block and PVC bristle. Complete model comes with a 48" metal handle with hang hole.

172002831	E507008	10", Small, Flagged Complete	1/ea.
-----------	---------	------------------------------	-------



D. O-CEDAR® MAXI-ANGLER BROOM

DIVERSEY

Big 13" sweeping surface with angled cut for sweeping in hard to get corners or under furniture. Washable, natural color polystyrene-flagged tip bristles are unaffected by water, alkaline, acids, grease or oil and won't wear down, break or fall out. Plastic angled shroud has patented handle locking mechanism. Ribbed, coated aluminum handle for comfortable grip. 15/16" dia. standard threaded handle.

15200004	91351	12"W, Flagged	4/cs.
----------	-------	---------------	-------



E. BRUTE® ANGLED BROOM

RUBBERMAID

Brute® angled brooms are ideal for cleaning hard-to-reach areas. Cut and shaped for easy sweeping. Flagged polypropylene fill.

17706385	6385	10 1/2"W, Gray, Aluminum Handle	6/cs.
----------	------	---------------------------------	-------



F. LOBBY PRO® LOBBY BROOM

RUBBERMAID

Ideal for one-handed cleaning under tables, fixtures, and hard-to-reach areas. Ideal for use in malls, restaurants, and lobbies. Tough polypropylene with flagged bristles trap fine particles. Will not stain, discolor, or absorb odors. Can be used wet or dry.

177078631	6374	Polypropylene Fill, 2"W x 7 1/2"L x 35"H	1/ea.
17707863	6374	Polypropylene Fill, 2"W x 7 1/2"L x 35"H	6/cs.



G. BRUTE® JUMBO SMOOTH SWEEP ANGLED BROOM RUBBERMAID

Ideal for cleaning hard-to-reach areas. Cut and shaped for easy sweeping. Black metal handle with polypropylene fill. Long-lasting stain-resistant polypropylene bristles. Permanent fusion set bristles won't pull out.

177063891	638906	1" dia., Black/Yellow	1/ea.
-----------	--------	-----------------------	-------



Push Brooms

PUSH BROOMS/FLOOR SWEEPS



A. VALUE LINE FLOOR SWEEPS

PRIME SOURCE®

Flagged Polystyrene

75004930	75004930	18"	12/cs.
75004931	75004931	24"	12/cs.
750049321	75004932	36"	1/ea.

Polypropylene Wide Band

750049341	75004934	24"	1/ea.
75004934	75004934	24"	12/cs.
75004935	75004935	36"	1/ea.

Black Tampico

750049401	75004940	18"	1/ea.
75004940	75004940	18"	12/cs.
750049411	75004941	24"	1/ea.
75004941	75004941	24"	12/cs.
75004942	75004942	36"	1/ea.
750049421	75004942	36"	4/cs.

Palmyra Garage

75004945	75004945	18"	12/cs.
750049461	75004946	24"	1/ea.
75004946	75004946	24"	12/cs.
75004947	75004947	36"	1/ea.

B. FINE SWEEPS

PRIME SOURCE®

Fine Sweeps w/Hardwood Blocks - Polypro

Flagged polypropylene fine sweeps remove dust and fine dirt particles with soft, lightly crimped and flagged filament. Use with tapered handle.

75009830	75009830	18", 3" Trim	12/cs.
750098311	75009831	24", 3" Trim	1/ea.
75009831	75009831	24", 3" Trim	12/cs.
750098321	75009832	36", 3" Trim	1/ea.
75009832	75009832	36", 3" Trim	6/cs.

Fine Sweeps - Synthetic

These split-tipped, synthetic fiber sweeps are excellent for picking up fine particles of dust and dirt on smooth floor surfaces. Gray fibers, 3" trim.

750049211	75004921	24", Wood Block	1/ea.
75004921	75004921	24", Wood Block	12/cs.
75004922	75004922	36", Wood Block	1/ea.

Fine/Medium Sweeps - Polypro

Heavy polypropylene center and flagged polypropylene around the outside perimeter to pick up both fine and medium particles. Black center fibers with gray casing fibers.

75004926	75004926	24", Wood Block	12/cs.
75004927	75004927	36", Wood Block	1/ea.



C. MEDIUM SWEEPS

PRIME SOURCE®

Dual Fill Medium Sweeps - Polypro

Medium sweep, polypro with heavy center and fine border.

750098251	75009825	18", 4" Trim	1/ea.
75009825	75009825	18", 4" Trim	12/cs.
750098261	75009826	24", 4" Trim	1/ea.
75009826	75009826	24", 4" Trim	12/cs.
750098271	75009827	36", 4" Trim	1/ea.

Medium Sweeps w/Hardwood Blocks - Tampico

Medium sweep, hardwood block with tampico bristles.

750049141	75004914	18", 3" Trim	1/ea.
75004914	75004914	18", 3" Trim	12/cs.
750049151	75004915	24", 3" Trim	1/ea.
75004915	75004915	24", 3" Trim	12/cs.
750049161	75004916	36", 3" Trim	1/ea.
75004916	75004916	36", 3" Trim	6/cs.



Push Brooms/Broom Braces & Handles



A. MEDIUM SWEEPS (CONT.) PRIME SOURCE®

Medium Sweeps w/Hardwood Blocks - Tampico

Medium sweeps provide an excellent all around tool for smooth and medium surfaces. Use with tapered handle.

750098401	75009840	18", 3" Trim	1/ea.
750098411	75009841	24", 3" Trim	1/ea.
75009841	75009841	24", 3" Trim	12/cs.
750098421	75009842	36", 3" Trim	1/ea.



B. HEAVY SWEEPS PRIME SOURCE®

Crimped Heavy Sweeps

Crimped heavy sweeps.

750098331	75009833	18"	1/ea.
750098341	75009834	24"	1/ea.
75009834	75009834	24"	12/cs.
750098351	75009835	36"	1/ea.

Heavy Sweep

Heavy sweep with 3" trim.

750098361	75009836	24", 3" Trim	1/ea.
-----------	----------	--------------	-------

Heavy Sweeps w/Hardwood Blocks - Polypro

Heavy sweeps with stiff polypropylene bristles for added durability. Use with tapered handle.

75009814	75009814	18", 3 1/4" Trim	12/cs.
75009815	75009815	24", 3 1/4" Trim	12/cs.
75009816	75009816	36", 3 1/4" Trim	6/cs.

Heavy Sweep w/Hardwood Block - Palmyra

Heavy sweeps with natural Palmyra for sweeping heavy debris. Use with tapered handle.

750098461	75009846	24", 4" Trim	1/ea.
-----------	----------	--------------	-------

Street Sweep w/Hardwood Block - Palmyra

Street sweeps are perfect for wet and dry applications, street cleaning and construction crews. Use with tapered handle.

75004913	75004913	16", 6 1/4" Trim	12/cs.
----------	----------	------------------	--------



BROOM BRACES/HANDLES

C. BROOM BRACES PRIME SOURCE®

Rust-resistant arm brace provides extra support for wide sweeps.

75009859	75009859	Large Arm Brace	12/cs.
----------	----------	-----------------	--------

Arm brace provides extra support for wide sweeps.

75004959	75004959	Handle Arm Brace	12/cs.
----------	----------	------------------	--------



D. BROOM HANDLES PRIME SOURCE®

Fiberglass

Great for use with wet mops, sweeps and brushes.

750098531	75009853	60" x 1", Flex Tip	1/ea.
75009853	75009853	60" x 1", Flex Tip	12/cs.

Lumathread

Threaded broom handle.

750098511	75009851	60" x 15/16"	1/ea.
75009851	75009851	60" x 15/16"	12/cs.

Metal Tip Threaded

Great for use with sweeps and scrub brushes.

750049511	75004951	60" x 15/16"	1/ea.
75004951	75004951	60" x 15/16"	12/cs.
177063641	6364LAC	60" x 15/16", Lacquered	1/ea.
75004953	75004953	60" x 1"	12/cs.
75004952	75004952	60" x 1 1/8"	12/cs.

Threaded Wood

750049501	75004950	60" x 15/16"	1/ea.
75004950	75004950	60" x 15/16"	12/cs.
750098501	75009850	60" x 15/16", Hardwood	1/ea.



Broom Handles/Dust Pans/Dusting Tools



A. BROOM HANDLES (CONT.) PRIME SOURCE®

Tapered Wood			
750049581	75004958	60"	1/ea.
750049541	75004954	60" x 1 1/8"	1/ea.
75004954	75004954	60" x 1 1/8"	12/cs.
Constructed from natural hardwood, this durable handle is available in many different sizes. Tapered end is great for quick and easy changes.			
750098541	75009854	60" x 1 1/8"	1/ea.
75009854	75009854	60" x 1 1/8"	12/cs.
276090601	M109060	60" x 1 1/8"	1/ea.
27609060	M109060	60" x 1 1/8"	12/cs.



DUST PANS



B. DUST PAN			CCP
Constructed of tough, yet flexible black plastic with thin front edge for maximum dirt pick-up.			
276008301	712	12"W, Black	1/ea.
27600830	712	12"W, Black	12/cs.



C. DUST PAN			CCP
Heavy-duty metal dust pan with thin sweep edge to eliminate repeated sweeping.			
276007151	715	12"W, Black	1/ea.
27600725	715	12"W, Black	12/cs.



D. LOBBY DUST PAN			CCP
Self-opening and closing lid. Chrome handle. Space-saving hanger for storage. Metal with powder-coat enamel.			
276014841	808	31 3/8" x 12 1/2" x 9 7/8", Black	1/ea.



E. LOBBY DUST PAN			CCP
Metal dust pan with powder-coated finish. Chrome handle with hanger.			
276007311	825	30 1/2" x 12" x 9", Black	1/ea.



F. LOBBY DUST PAN			CCP
Plastic hopper with strong metal handle. Pan snap-locks in use and releases to dump or carry. Space-saving hanger for storage. The true-edge of pan conforms to floor to eliminate need for repeated sweeping.			
276009121	912BK	10 3/4" x 12" x 36 3/4", Black	1/ea.
27600912	912BK	10 3/4" x 12" x 36 3/4", Black	6/cs.



G. HEAVY-DUTY DUST PAN			RUBBERMAID
Heavy-duty plastic construction. Thin front edge for easy dirt pick-up.			
177020051	2005	8 1/4"W x 12 1/4"L x 2 5/8"D, Charcoal	1/ea.
17702005	2005	8 1/4"W x 12 1/4"L x 2 5/8"D, Charcoal	12/cs.

H. LOBBY PRO® UPRIGHT DUST PAN			RUBBERMAID
Stylish pan design. Durable rear wheels for improved wear resistance.			
177041491	2531BLA	Black	1/ea.
17704149	2531BLA	Black	6/cs.

DUSTING TOOLS



I. CHIX® MASSLINN® DUST CLOTH			CHICOPEE
Heavy-duty, stretch activated dusting cloth with mineral oil treatment. Safe to use on all floor surfaces. Does not leave residue or lint behind. Contains Microban®.			
25600911	0911	50 ct., 24" x 24", Yellow	100/cs.



J. STRETCH 'N DUST® CLEANING CLOTH			CHICOPEE
Treated cloth becomes a dust magnet and traps dust when stretched. Leaves surfaces dust-free without the trouble and cost of sprays. Picks up more dust in one pass than conventional cloths with sprays. Eliminates waxy build-up. Contains Microban®.			
25600416	0416	20 ct., 23 1/4" x 24", Yellow/Orange	100/cs.

Dusting Tools



A. PLEDGE® GRAB-IT™ DRY REFILL CLOTHS DIVERSEY

Cloths contain no sprays or polish and can be used alone or with the Pledge® Grab-It™ Sweeper. When you're done, simply throw the cloths away. Safe for use on wood, ceramic, vinyl and many other hard surfaces. Does not contain sprays or polish so they won't leave a residue. Do not launder. Do not dispose of in toilets.

15203281 CB663281 32 ct. 6/cs.



B. OVERHEAD DUSTING TOOLS RUBBERMAID

The sensible solution to routine overhead dusting. Launderable head for long product life. Telescoping handle for simple and efficient overhead use.

17701300 T130 8½" Extension Handle 12/cs.
17701200 T120 51" Extension Handle, Angled Head 12/cs.



C. SWIFFER MAX® DUSTING SYSTEM PROCTER & GAMBLE

Swiffer Max® is bigger for faster and easier cleaning. Its new textured head picks up even more particles and the thick cloths still use electrostatic action and deep Lift and Lock Pockets™ to attract and trap household soils. Safe for wood, ceramic, vinyl, laminate floors, and electronics.

16907108 37108 17"W, Sweeper Tool Only 3/cs.
16907109 37109 17"W, Refills Only, 16 Cloths 6/cs.



D. SWIFFER® DUSTING PROCTER & GAMBLE

Dusting Cloth

Dry, disposable cloths which can be attached to the sweeper or used alone for hand dusting. Starter kit includes one sweeper and eight refill cloths. Lightweight and easy-to-use with a flexible swivel head to get into hard-to-reach places.

169042405 24240 32 ct., 8" x 11", Dry Swiffer Refills 32/bx.
16904240 24240 32 ct., 8" x 11", Dry Swiffer Refills 192/cs.

Regular Sweeper/Cloths

Gets into the tough spots easily, avoiding bending or ladder use. Swiffer wet cloths for the Swiffer Sweeper remove dust for a dust-free clean. Safe for wood, ceramic, vinyl, tile, electronics and other hard surfaces. Leaves no residue.

16909061 09060 10"W, Implement Only 3/cs.
16905154 35154 12 Wet Cloths 12/cs.

Dusters/Refills

Swiffer® dusters use thousands of soft, fluffy fibers that can change shape to fit wherever they must go with a handle that allows you to get to where you can't reach. You'll be surprised to discover how easy it is to dust both small places and large areas. When you're finished cleaning, just toss the duster and the dust into the garbage. Extends to 3' long and allows the Swiffer® duster to reach and dust even more areas.

16904623 40509 5 Dusters, Short Handle 45/cs.
16901767 41767 Duster Refills, 10 ct. 60/cs.
16904750 44750 5 Dusters, Extendable Handle Kit 12/cs.



MICROFIBER DUSTING TOOLS

E. MICROFIBER CLOTHS PRIME SOURCE®

Classic

For streak-free cleaning of glass and polished metal surfaces.

75004929 75004929 12" x 12", Blue 12/pk.

Supremo™

Can be used dry for dusting or damp for removing tough dirt and grime. Textured surface captures dust and dirt using less water, chemicals and effort.

75004938 75004938 12" x 12", Blue 12/cs.



Microfiber Dusting Tools/Wall Washer



A. MICROFIBER CLOTHS CCP

Classic™

Perfect for cleaning soap, grease or finger prints from windows, mirrors and polished metal surfaces. Streak-free finish. Can be laundered five times more than 100% cotton towels.

27600228	<i>E222022</i>	10" x 7", Green, Mitt	12/cs.
27602222	<i>E222000</i>	12" x 12", Green, Cloth	12/cs.

Supremo™

All purpose cleaning cloths. Great for dusting and cleaning all types of surfaces.

27602210	<i>E221000</i>	12" x 12", Blue	12/cs.
27602211	<i>E220000</i>	12" x 12", Green	12/cs.



B. WYPALL® MICROFIBER CLOTHS KIMBERLY-CLARK

Microfiber cloths with Microban® protection are durable, remarkably absorbent, and environmentally friendly. No chemicals needed. Cleans virtually any surface; wet, dry, or damp. Absorbs eight times its weight in liquid. Can be laundered 300 times. Color-coding helps reduce cross-contamination.

15403620	<i>83620</i>	15 ³ / ₄ " x 15 ³ / ₄ ", Blue	24/cs.
15403630	<i>83630</i>	15 ³ / ₄ " x 15 ³ / ₄ ", Green	24/cs.
15403980	<i>83980</i>	15 ³ / ₄ " x 15 ³ / ₄ ", Red	24/cs.
15403610	<i>83610</i>	15 ³ / ₄ " x 15 ³ / ₄ ", Yellow	24/cs.



C. HYGEN™ MICROFIBER GENERAL PURPOSE CLOTHS RUBBERMAID

Best-in-class microfiber delivers superior cleaning performance and durability. Color-coded products help reduce cross-contamination by differentiating area of use. Patent-pending zig-zag scrubbing strips and high quality knitting for better absorption and debris pick-up. Cleans 25% better than conventional microfiber and traditional cotton cloths. Durable up to 500 launderings. Bleach safe.

177041231	<i>Q620RD00</i>	16" x 16", Red	1/ea.
17704120	<i>Q61000YL00</i>	16" x 16", Yellow	12/cs.



D. MICROFLEX™ DUSTER CCP

Flexible, thin foam frame allows for effective cleaning in tight, hard-to-reach areas. Frame accepts a hand held handle or either one of our Pro Flat mop handles for high area cleaning. Microfiber refill for durability and long product life. Simply rinse away dirt with water after every use. Duster refills available separately.

27606025	<i>E224000</i>	2" x 27", Complete	1/ea.
27602907	<i>E224100</i>	2" x 22", Refills	3/cs.



E. MICROFIBER CLEANING SYSTEM DUSTER RUBBERMAID

Effectively extends reach and removes soil from high and awkward places. 20" flexible wand conforms to irregular surfaces for easy cleaning. High-pile sleeves reach into crevices effectively removing dust, dirt and grime. Quick connect mechanism converts handheld duster to high reach tool. Replacement sleeves available for added product life.

Quick Connect Flexible Dusting Wand

177008551	<i>Q850</i>	28 ³ / ₄ "L x 1 ¹ / ₂ "H x 3 ¹ / ₂ "W, Black	1/ea.
------------------	-------------	--	-------

Wand Duster Replacement Sleeve

177008571	<i>Q851</i>	22 ³ / ₄ "L x 3/4"H x 3 ¹ / ₄ "W, Green	1/ea.
------------------	-------------	---	-------



WALL WASHER

F. WALL WASHER KIT RUBBERMAID

Kit includes: (1) handle, (1) plastic head, (2) cotton pads. Features a pivoting head for smooth, even control. Raised-ribbed design works with either side pressure or downward pressure mop wringers without requiring additional adapters. Washable pads remove easily for convenient laundering.

17701226	<i>S226</i>	60", Aluminum Handle	1/ea.
-----------------	-------------	----------------------	-------

Dust Mops



DUST MOPS/HARDWARE

A. PERMATWIST™ DUST MOPS

PRIME SOURCE®

Exclusive bonding process of 100% ring-spun cotton yarn virtually eliminates fraying and linting. Brilliant, permanent colors keep this duster looking new. PermaTwist delivers unsurpassed durability and performance.

75004760	75004760	18" x 5", Blue	12/cs.
750047611	75004761	24" x 5", Blue	1/ea.
75004761	75004761	24" x 5", Blue	12/cs.
750047621	75004762	36" x 5", Blue	1/ea.
75004762	75004762	36" x 5", Blue	12/cs.
75004763	75004763	48" x 5", Blue	12/cs.
75004764	75004764	60" x 5", Blue	12/cs.
75004631	75004631	24" x 5", Green	12/cs.
75004630	75004630	36" x 5", Green	12/cs.
75004632	75004632	48" x 5", Green	6/cs.

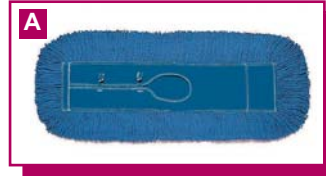

B. DISPOSABLE DUST MOP

PRIME SOURCE®

Cotton/synthetic yarn with polyester backing for performance, durability and value. Split center provides a trap to collect dust and dirt. Use with Swivel Snap™ frame and handle.

750046381	75004638	36" x 5"	1/ea.
-----------	----------	----------	-------



C. TRIANGLE DUST MOP

PRIME SOURCE®

These small dusters lie flat in tight areas like offices and classrooms. Removable mop heads are launderable and are standard cotton blend yarn. 4" x 8½" wire frame attached to 54" wood handle. Yarn spread measures 12" x 17".

75004775	75004775	Refills Only	12/cs.
----------	----------	--------------	--------



D. SWIVEL SNAP™ DUST MOPS

PRIME SOURCE®

Industry standard dust mop is constructed of four-ply cotton blended yarn with a durable synthetic backing. Absorbent yarn provides excellent dust retention.

75004765	75004765	18" x 5", Natural	12/cs.
750047661	75004766	24" x 5", Natural	1/ea.
75004766	75004766	24" x 5", Natural	12/cs.
75004767	75004767	36" x 5", Natural	12/cs.
75004769	75004769	60" x 5", Natural	12/cs.



E. TYPAR™ DISPOSABLE DUST MOPS

PRIME SOURCE®

Cotton/synthetic yarn with Typar backing provides performance, durability and value. Bulky, absorbent, pre-treated yarn collects and retains more dust and will cover over a million square feet before replacement is needed. Split center provides a trap to collect even more dust.

750047701	75004770	18" x 5", Natural	1/ea.
75004770	75004770	18" x 5", Natural	12/cs.
750047711	75004771	24" x 5", Natural	1/ea.
75004771	75004771	24" x 5", Natural	12/cs.
750047721	75004772	36" x 5", Natural	1/ea.
75004772	75004772	36" x 5", Natural	12/cs.
75004773	75004773	48" x 5", Natural	12/cs.



F. BLENDED CUT-END DISPOSABLE DUST MOPS

RUBBERMAID

Soft, open-twist blended cut-end yarn for increased dust pick-up. Pre-treated and good for 500,000 square feet of dust mopping before replacement. Full-tie backing style.

177009071	L153WH00	5" x 24", White	1/ea.
177036101	L155WH00	5" x 36", White	1/ea.



G. DISPOSABLE COTTON DUST MOPS

RUBBERMAID

Economical cotton cut-end dust mop. Pretreated for your convenience. Full-tie backing.

17700253	L253	5" x 24", White	12/cs.
17703255	L255	5" x 36", White	12/cs.



Dust Mops/Frames/Handles/Microfiber Mops

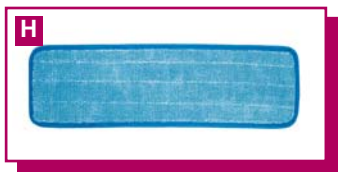

A. KUT-A-WAY® DUST MOPS RUBBERMAID

Cut-end mop excellent for general purpose dust mopping. Pre-laundered and pre-shrunk. Launderable for long product life. Envelope backing style.

177006291	K155BL00	36" x 5", Blue	1/ea.
177009251	K155WH00	36" x 5", White	1/ea.
177015921	K158WH00	60" x 5", White	1/ea.

B. TRAPPER® DUST MOP RUBBERMAID

Looped-end, balanced blend dust mop for general purpose dust mopping. Pre-treated, pre-shrunk and fully launderable for long product life. Envelope backing style.

177003271	J155	5" x 36", Yellow	1/ea.
-----------	------	------------------	-------

C. SWIVEL SNAP™ DUST MOP FRAMES PRIME SOURCE®

Constructed of durable, rust-resistant black powder-coated metal wire.

75004778	75004778	12" x 5"	12/cs.
750047791	75004779	18" x 5"	1/ea.
75004779	75004779	18" x 5"	12/cs.
750047801	75004780	24" x 5"	1/ea.
75004780	75004780	24" x 5"	12/cs.
750047811	75004781	36" x 5"	1/ea.
75004781	75004781	36" x 5"	12/cs.
750047821	75004782	48" x 5"	1/ea.
75004782	75004782	48" x 5"	12/cs.
750047831	75004783	60" x 5"	1/ea.
75004783	75004783	60" x 5"	12/cs.
75004784	75004784	72" x 5"	12/cs.

D. SWIVEL SNAP™ DUST MOP FRAME CCP

Constructed of durable, rust-resistant black powder-coated metal wire.

276002671	C702024	24" x 5"	1/ea.
-----------	---------	----------	-------

E. SWIVEL SNAP™ DUST MOP HANDLE PRIME SOURCE®

Handles feature 180° swivel action or rigid position and spring clip for easy attachment to frame.

750047851	75004785	60"L, Wood	1/ea.
75004785	75004785	60"L, Wood	12/cs.

F. SNAP-ON DUST MOP HANDLE RUBBERMAID

Attach to the snap-on dust mop frame. Sliding collar locks the handle into position or allows for a full 360° swivel action.

177091161	M116	60"L, Hardwood Handle	1/ea.
-----------	------	-----------------------	-------

MICROFIBER MOPS/HARDWARE

G. SUPER PRO MICROFIBER MOPS PRIME SOURCE®

For use with Pro Flat mop handles and frames. Constructed of 3-micron fiber, mops efficiently remove, absorb, and accumulate virtually any type of dust, dirt, grease, or contaminant.

75004962	75004962	5" x 12", Blue	10/cs.
75004963	75004963	5" x 20", Blue	10/cs.
75004966	75004966	5" x 20", Red	10/cs.
75004964	75004964	5" x 26", Blue	10/cs.

H. SUPER PRO II™ MICROFIBER REFILLS CCP

Made of 100% microfiber and are launderable up to 500 times. Looped-end construction and Perma-Stitch sewn border guarantee extreme durability. Hook and loop attachment for easy installation and removal from frame. Use for damp or dry mopping.

27602991	C103020	5" x 20", Blue	10/cs.
27602998	C108020	5" x 20", Green	10/cs.
27602996	C104020	5" x 20", Red	10/cs.
27602995	C107020	5" x 20", Yellow	10/cs.
27602992	C103026	5" x 26", Blue	10/cs.
27602997	C104026	5" x 26", Red	10/cs.

Microfiber Mops/Frames/Handles



A. SUPER PRO FINISH MOP MICROFIBER REFILL CCP

Microfiber finish flat mop is looped-end and constructed of high-wet modulus rayon blend yarn that provides quick, controlled liquid release. The finish flat mop will cover a 20" wide swath. Unlike conventional finish mops, 100% of the floor finish goes onto the floor along with full contact of the refill to the surface allowing better productivity and less chemical wasted in the mop. Should be rinsed after every use.

27602980 C106020 5" x 20", Light Blue 6/cs.



B. THE AGGRESSOR™ MICROFIBER SCRUBBING REFILL CCP

Innovative combination of microfiber yarn and synthetic stiff brush fibers. Designed to remove debris stuck to the floor that normal "yarn only" microfiber flat mops cannot.

276001261 C109020 5" x 20", Blue/White 1/ea.

27600126 C109020 5" x 20", Blue/White 10/cs.



C. MICROFIBER CLEANING SYSTEM PADS RUBBERMAID

Dense "Ultra-Fine" quality fiber removes more dust, dirt and bacteria than conventional cleaning products. Advanced hook-and-loop backing holds up under harsh laundering conditions and attaches pads more securely. Durable pad construction withstands more than 300 launderings. Double finished edges retain pad shape with use over time. Color-coded products help reduce cross-contamination by differentiating area of use.

177041001 Q410BL00 18½"L x 5½"W, Blue, 18" Wet Room Pad 1/ea.

17704100 Q410BL00 18½"L x 5½"W, Blue, 18" Wet Room Pad 12/cs.

177004361 Q436GR00 36½"L x 5½"W, Green, 36" Dry Hall Pad 1/ea.



D. MICROFIBER FINISH PAD RUBBERMAID

Traditionally colored and optimally shaped for smooth, even application of floor finish. Dense "Ultra-Fine" quality fiber removes more dust, dirt and bacteria than conventional cleaning products. Foam liner controls liquid content and release. Advanced hook-and-loop backing holds-up under harsh laundering conditions and attaches pads more securely. Durable pad construction withstands more than 300 launderings. Double finished edges retain pad shape with use over time.

177008921 Q800WH00 18", White/Blue 1/ea.



E. PRO FLAT MOP FRAME PRIME SOURCE®

For use with Pro Flat mop handles and Super Pro microfiber mops.

75004968 75004968 3" x 18" 5/cs.



F. PRO II™ FLAT MOP FRAMES CCP

Lightweight design allows for dramatic improvements in labor productivity. Trapezoid head effectively cleans corners and edges. 360° swivel attachment for maneuvering in tight areas. Handle locking clip to secure handle to frame connector. Designed to complement our line of microfiber refills.

276071701 C717018 4¾" x 18", Blue/Silver 1/ea.

276071711 C717024 4¾" x 26", Blue/Silver 1/ea.

27607171 C717024 4¾" x 26", Blue/Silver 10/cs.



G. PRO™ FLAT MOP HANDLES CCP

Made of lightweight, long-lasting aluminum that will not rust or corrode. Twist lock mechanism allows extendable handle to adjust from 39" to 60".

75004949 75004949 33" to 60", Telescopic 6/cs.

276071401 C714000 39" to 60" 1/ea.

27607140 C714000 39" to 60" 10/cs.



Microfiber Mopping



A. HYGEN™ QUICK-CONNECT FRAME/HANDLES RUBBERMAID

Quick-Connect Wet/Dry Frame

Flat profile slides easily under furniture and equipment. Lightweight aluminum construction for improved productivity. One-step connecting mechanism speeds mop assembly and changeover. Flat frame profile is sanitary and easy to clean. Replaceable hook-and-loop strips' cost efficiently extend product life.

177055601 Q560YL00 3 1/2"W x 18"L x 1 1/2"H, Yellow 1/ea.

Handles

Lightweight aluminum construction for improved productivity. One-step connecting mechanism speeds mop assembly and changeover. User-friendly grip makes handle more comfortable to use.

177007501 Q750 58" 1/ea.

177010041 Q755 48" - 72", Extension Handle 1/ea.



B. ERGOWORX™ TOUCHLESS MICROTEK CLEANING SYSTEM CCP

Designed to fit all the most popular plastic janitorial carts made, including those manufactured by Continental (old and new styles), RCP, Impact/White, Akro-Mils and most Chinese imports. Also designed to fit all the most popular stainless steel janitorial carts made, including those manufactured by Geerpres® and Royce-Rolls. The ErgoWorx™ solution and discharge buckets are made from Derma-Tek™ non-porous plastic so they are easy to clean and help maintain a professional appearance. The auto-discharge mop frame is made from strong and durable glass-filled nylon. Completely non-ferrous, so it is safe for use in areas with MRI equipment and will not rust or corrode. Exclusive to CCP, the patented ErgoWorx™ touchless auto-discharge mop frame eliminates the need to touch the soiled/contaminated microfiber mop head, preventing cross-contamination. System includes: (1) solution bucket w/perforated screen, (1) discharge bucket w/aluminum discharge rod and (1) auto-discharge microfiber mop frame. The microfiber trolley can be added to the SYS-5 to create a mobile cleaning system that is both compact and efficient. The 3" non-marking, all-swivel casters provide finger touch mobility, ideal for tight hallways and small rooms. The MFT-5 is designed to accommodate common cleaning tools including a wet floor sign, microflex duster, wipes and RTU trigger sprayer bottles. ErgoWorx™ is completely non-ferrous, so it is safe for use in areas with MRI equipment and will not rust or corrode.

27605050 SYS5 22" x 19 7/8" x 11 5/8", Complete System 1/ea.

276050511 SB5YW 22" x 8" x 11 1/8", Discharge Bucket w/Aluminum Discharge Rod 1/ea.

276012001 MF5BK 18" x 5 5/8" x 1 3/4", Auto-Discharge Mop Frame, Black 1/ea.

27605052 MFT5BK 31 3/4" x 23" x 38 1/2", Trolley, Black 1/ea.



C. RUBBERMAID PULSE™ MICROFIBER FLOOR CLEANING SYSTEM RUBBERMAID

Clean more square feet in less time with the Rubbermaid Pulse™ microfiber floor cleaning system. Red ergonomic trigger handle dispenses three streams of cleaning solution with each press. Lightweight construction, weighs only 4 lbs. when fully loaded with solution. High-capacity refillable reservoir holds 21 oz. of solution to clean up to 850 sq. ft. of floor space. Reservoir windows allow easy monitoring of fluid level. 18" Quick-Connect frame included. Also works with Rubbermaid 11" and 24" Quick-Connect frames and pads.

17700121 Q969 56"L x 4 7/8"W x 3 3/4"H, 21 oz., Yellow 1/ea.

Looped-End Mops



LOOPED-END MOPS

A. LOOPED-END WET MOPS

PRIME SOURCE®

Bulldog™ Blended

The economical choice. This is the perfect mop to choose to upgrade from a cut-end mop to a looped-end mop and is ideal for general purpose cleaning. Four-ply cotton/synthetic blend.

75004674	75004674	5" Headband, Medium, Blue	12/cs.
75004667	75004667	5" Headband, Small, Natural	12/cs.
750046681	75004668	5" Headband, Medium, Natural	1/ea.
75004668	75004668	5" Headband, Medium, Natural	12/cs.
750046691	75004669	5" Headband, Large, Natural	1/ea.
75004669	75004669	5" Headband, Large, Natural	12/cs.

Hospital Pro M™ Blended

Designed for the demanding needs of the health care industry, the Hospital Pro M stands up to tough use and heavy washing. Its high-quality, integrated blend of cotton/rayon/synthetic fibers insures durability and absorbency. Also ideal for all-purpose cleaning.

75004723	75004723	5" Headband, Small, Blue	12/cs.
750047241	75004724	5" Headband, Medium, Blue	1/ea.
750047251	75004725	5" Headband, Large, Blue	1/ea.
75004725	75004725	5" Headband, Large, Blue	12/cs.
75004720	75004720	5" Headband, Small, White	12/cs.
75004721	75004721	5" Headband, Medium, White	12/cs.
75004722	75004722	5" Headband, Large, White	12/cs.

J.W. Atomic Loop™ Blended

This economical cotton/rayon/synthetic blend mop cleans two to three times the area with up to six times the life of a conventional cut-end mop.

750047381	75004738	1 1/4" Headband, Medium, Blue/White	1/ea.
75004738	75004738	1 1/4" Headband, Medium, Blue/White	12/cs.
75004739	75004739	1 1/4" Headband, Large, Blue/White	12/cs.
750047341	75004734	5" Headband, Small, Blue	1/ea.
75004734	75004734	5" Headband, Small, Blue	12/cs.
75004735	75004735	5" Headband, Medium, Blue	12/cs.
750047361	75004736	5" Headband, Large, Blue	1/ea.
75004736	75004736	5" Headband, Large, Blue	12/cs.
75004737	75004737	5" Headband, X-Large, Blue	12/cs.
750047561	75004756	5" Headband, Medium, Green	1/ea.
75004756	75004756	5" Headband, Medium, Green	12/cs.
750047311	75004731	5" Headband, Medium, Natural	1/ea.
75004731	75004731	5" Headband, Medium, Natural	12/cs.
75004732	75004732	5" Headband, Large, Natural	12/cs.
75004733	75004733	5" Headband, X-Large, Natural	12/cs.

Rough Rider™

Very absorbent strands make this mop great for foodservice and other general maintenance uses. Stands up to any floor surface including stone and concrete.

75004728	75004728	5" Mesh Headband, Medium, White	12/cs.
75004729	75004729	5" Mesh Headband, Large, White	12/cs.

B. BULLDOG™ COTTON LOOPED-END MOP

CCP

The economical choice. This is the perfect mop to choose to upgrade from a cut-end mop to a looped-end mop and is ideal for general purpose cleaning.

276006881	A04902	5" Headband, Medium, Natural	1/ea.
-----------	--------	------------------------------	-------



Looped-End & Cut-End Mops



A. LOOPED-END WET MOPS

RUBBERMAID

All-Pro™ Blend

A long lasting mop with cotton/synthetic yarn blend for almost twice the absorbency of cotton. Looped-ends reduce fraying associated with cut-end mops. Universal headband fits both side-loading and clamp-style handles.

177039001 E239 32 oz., Blue 1/ea.

All-Pro™ Universal Headband Cotton

Excellent, all-purpose mop for general cleaning. Looped-ends reduce fraying associated with cut-end mops. Universal headband fits both side-loading and clamp-style handles.

177003701 E138 24 oz., White 1/ea.

Super Stitch® Blend

Outperforms and outlasts premium cut-end mops. Balanced blend of cotton and synthetic yarns for absorbency and strength. Looped-ends and yarn tailband mop for greater floor coverage.

177023061 D25306BL00 5" Headband, Large, Blue 1/ea.

17702306 D25306BL00 5" Headband, Large, Blue 6/cs.

Swinger Loop® Blend

Looped-end, tailbanded mop for greater floor coverage. Four-ply, balanced blend of cotton and synthetic yarn for absorbency and strength. Launderable for long product life.

17700466 C15306WH00 5" Headband, Large, White 6/cs.

Web Foot® Shrinkless Blend

The ultimate, launderable wet mop. Contains antimicrobial product protection, which inhibits the growth of bacteria that cause odors and stains. Four-ply, balanced blend of cotton and synthetic yarn withstands repeated launderings without shrinkage. Looped-ends and tailbanding reduce tangling for like-new performance after every laundering. Colorfast colors will not fade with repeated launderings.

17705209 A25206WH00 5" Headband, Medium, White 6/cs.

Web Foot® Blend

Contains Microban® antimicrobial product protection, which inhibits the growth of bacteria that cause odors and stains. Balanced blend of cotton and synthetic fibers delivers up to five times the absorbency of cotton mops. Looped-end, open-twist yarn reduces linting. Tailband allows the mop to cover more floor area per stroke, saving time and money.

177011631 A11206WH00 1" Headband, Medium, White 1/ea.

17701163 A11206WH00 1" Headband, Medium, White 6/cs.

17700918 A11306WH00 1" Headband, Large, White 6/cs.

177004681 A15206WH00 5" Headband, Medium, White 1/ea.

17700468 A15206WH00 5" Headband, Medium, White 6/cs.

177004691 A15306WH00 5" Headband, Large, White 1/ea.

17700469 A15306WH00 5" Headband, Large, White 6/cs.

CUT-END MOPS

B. CUT-END COTTON WET MOPS

PRIME SOURCE®

Choice

Constructed of natural cotton fiber. Four-ply yarn gives the mop greater strength and durability. Traps dirt for quick clean-ups and all general purpose floor care.

750046511 75004651 1 1/4" Headband, 16#, White 1/ea.

75004651 75004651 1 1/4" Headband, 16#, White 12/cs.

750046521 75004652 1 1/4" Headband, 20#, White 1/ea.

75004652 75004652 1 1/4" Headband, 20#, White 12/cs.

750046531 75004653 1 1/4" Headband, 24#, White 1/ea.

75004653 75004653 1 1/4" Headband, 24#, White 12/cs.

750046537 75004653 1 1/4" Headband, 24#, White, Import 12/cs.

750046551 75004655 1 1/4" Headband, 32#, White 1/ea.

75004655 75004655 1 1/4" Headband, 32#, White 12/cs.

75004661 75004661 5" Headband, 16#, White 12/cs.

750046617 75004661 5" Headband, 16#, White, Import 12/cs.

75004662 75004662 5" Headband, 20#, White 12/cs.

750046631 75004663 5" Headband, 24#, White 1/ea.

750046637 75004663 5" Headband, 24#, White, Import 12/cs.

75004663 75004663 5" Headband, 24#, White 12/cs.

750046651 75004665 5" Headband, 32#, White 1/ea.

750046657 75004665 5" Headband, 32#, White, Import 12/cs.

75004665 75004665 5" Headband, 32#, White 12/cs.

Cut-End Mops



A. CUT-END COTTON WET MOPS (CONT.) PRIME SOURCE®

Go-Go™

Low-cost, high quality cut-end mops feature colored yarn to keep mop looking new. With no break-in required, these absorbent, tough mops go to work right away. Ideal for use in public areas.

75004648	75004648	1 1/4" Headband, #24, Blue	12/cs.
75004649	75004649	1 1/4" Headband, #32, Blue	12/cs.

Fan

Supreme, regular width, labor saving cotton fan mops feature four-sewn tailbands that keep yarn strands fanned out for greater surface coverage and less tangles.

75004706	75004706	1 1/4" Headband, 12 oz.	12/cs.
75004707	75004707	1 1/4" Headband, 16 oz.	12/cs.
750047081	75004708	1 1/4" Headband, 20 oz.	1/ea.
750047091	75004709	1 1/4" Headband, 24 oz.	1/ea.
75004709	75004709	1 1/4" Headband, 24 oz.	12/cs.
75004710	75004710	1 1/4" Headband, 32 oz.	12/cs.

No Marr Pinnacle™

Pinnacle wet mops lie flat on the floor. Screw-on attachment makes mop head changes quick and easy. No Marr style eliminates marring of floors.

75004687	75004687	16 oz., Natural	12/cs.
750046881	75004688	20 oz., Natural	1/ea.
75004688	75004688	20 oz., Natural	12/cs.
750046891	75004689	24 oz., Natural	1/ea.
75004689	75004689	24 oz., Natural	12/cs.
75004690	75004690	32 oz., Natural	12/cs.
75004791	75004791	16 oz., White	12/cs.
75004793	75004793	24 oz., White	12/cs.



B. CUT-END RAYON WET MOPS PRIME SOURCE®

Choice

Constructed of four-ply synthetic fiber. Perfect for economy finishing and disinfecting. Rayon yarn soaks up spills instantly.

75004671	75004671	1 1/4" Headband, #16, Natural	12/cs.
75004672	75004672	1 1/4" Headband, #20, Natural	12/cs.
750046731	75004673	1 1/4" Headband, #24, Natural	1/ea.
75004673	75004673	1 1/4" Headband, #24, Natural	12/cs.
750046737	75004673	1 1/4" Headband, #24, Natural, Import	12/cs.
75004675	75004675	1 1/4" Headband, #32, Natural	12/cs.
75004681	75004681	5" Headband, #16, Natural	12/cs.
75004682	75004682	5" Headband, #20, Natural	12/cs.
750046831	75004683	5" Headband, #24, Natural	1/ea.
75004683	75004683	5" Headband, #24, Natural	12/cs.
75004685	75004685	5" Headband, #32, Natural	12/cs.

Fan

Rayon, regular width, labor saving fan mops feature four-sewn tailbands that keep yarn strands fanned out for greater surface coverage and less tangles.

75004702	75004702	1 1/4" Headband, 16 oz.	12/cs.
75004703	75004703	1 1/4" Headband, 20 oz.	12/cs.
75004704	75004704	1 1/4" Headband, 24 oz.	12/cs.

Lie-Flat

Constructed of 4-ply synthetic fiber. Perfect for economy finishing and disinfecting. Rayon yarn soaks up spills instantly.

75004797	75004797	#24	12/cs.
-----------------	----------	-----	--------

No Marr Pinnacle™

Pinnacle wet mops lie flat on the floor. Screw-on attachment makes mop head changes quick and easy. No Marr style eliminates marring of floors.

75004691	75004691	16 oz., White	12/cs.
75004692	75004692	20 oz., White	12/cs.
75004693	75004693	24 oz., White	12/cs.
75004694	75004694	32 oz., White	12/cs.



Cut-End Mops/Deck Mops



A. CUT-END RAYON WET MOPS (CONT.) PRIME SOURCE®

Stinger

Four-ply mop for general purpose mopping. Natural cotton fibers.

750047161	75004716	1 1/4" Headband, 16 oz.	1/ea.
75004716	75004716	1 1/4" Headband, 16 oz.	12/cs.
750047171	75004717	1 1/4" Headband, 20 oz.	1/ea.
75004717	75004717	1 1/4" Headband, 20 oz.	12/cs.
750047181	75004718	1 1/4" Headband, 24 oz.	1/ea.
75004718	75004718	1 1/4" Headband, 24 oz.	12/cs.
750047191	75004719	1 1/4" Headband, 32 oz.	1/ea.
75004719	75004719	1 1/4" Headband, 32 oz.	12/cs.
75004713	75004713	5" Headband, 24 oz.	12/cs.

Texray

Four-ply rayon yarn is great for liquid pick-up, economy finishing and disinfecting.

750047441	75004744	1 1/4" Headband, 16 oz.	1/ea.
75004744	75004744	1 1/4" Headband, 16 oz.	12/cs.
750047451	75004745	1 1/4" Headband, 20 oz.	1/ea.
75004745	75004745	1 1/4" Headband, 20 oz.	12/cs.
750047461	75004746	1 1/4" Headband, 24 oz.	1/ea.
75004746	75004746	1 1/4" Headband, 24 oz.	12/cs.
75004747	75004747	1 1/4" Headband, 32 oz.	12/cs.
750047431	75004743	5" Headband, 32 oz.	1/ea.

B. CHOICE COTTON CUT-END WET MOP CCP

Low end cut-end mop is great for economical general cleaning and disinfecting.

27600129	A957124	1 1/4" Headband, #32, White	12/cs.
----------	---------	-----------------------------	--------

C. ROUGH RIDER™ CUT-END MOP HEAD CCP

Cotton strands provide good absorption in this economical cut-end mop. Knitted material gives this mop much more strength than other cut-end mops.

27602213	A42213	1 1/4" Headband, Large	12/cs.
----------	--------	------------------------	--------

D. COTTON MOP & HANDLE COMBINATION RUBBERMAID

Cotton mop head and handle combination.

177042031	GO43	8 oz., White, Replacement Head Only	1/ea.
-----------	------	-------------------------------------	-------

E. DURA-PRO® BLEND MOPS RUBBERMAID

Cut-end, four-ply cotton/rayon/synthetic yarn blend for good performance and durability.

17700516	F516BL00	1" Headband, 16 oz., Blue	12/cs.
17700515	F516WH00	1" Headband, 16 oz., White	12/cs.
17706520	F519WH00	1" Headband, 32 oz., White	12/cs.

F. PREMIUM CUT-END COTTON MOP RUBBERMAID

Economical, four-ply cut-end mop for general purpose cleaning.

177000721	F117	1" Headband, 20 oz., White	1/ea.
-----------	------	----------------------------	-------

G. VALUE-PRO™ COTTON MOP RUBBERMAID

Economical, cut-end mop for all purpose cleaning.

177011171	V117	1" Headband, 20#, White	1/ea.
-----------	------	-------------------------	-------

YACHT/DECK MOPS

H. LEADER YACHT MOPS PRIME SOURCE®

Cord-tied yarn is securely attached to a wood handle. Ideal for infrequent users such as small stores, offices and garages.

750047491	75004749	16 oz.	1/ea.
75004749	75004749	16 oz.	6/cs.
750047261	75004726	24 oz.	1/ea.
75004726	75004726	24 oz.	6/cs.
75004727	75004727	32 oz.	6/cs.

Deck Mops/Mop Handles/Sponge Mops



A. COTTON DECK MOPS PRIME SOURCE®

Cotton deck mops.

75004643	75004643	#24	6/cs.
75004644	75004644	#26	6/cs.
75004642	75004642	#32	6/cs.

MOP HANDLES

B. PINNACLE™ WET MOP HANDLE PRIME SOURCE®

Metal threaded connector is countersunk into wood handle. For use with Pinnacle style mops only.

750047001	75004700	60"L	1/ea.
75004700	75004700	60"L	12/cs.

C. QUICK CHANGE METAL STIRRUP MOP HANDLE PRIME SOURCE®

Stirrup mop handle with a quick release bar (yoke). Recommended for narrow bands.

750046951	75004695	60"L	1/ea.
75004695	75004695	60"L	12/cs.

D. SPEED CHANGE™ MOP HANDLES PRIME SOURCE®

High-impact plastic head features a side release gate for fast and easy changes.

Recommended for narrow bands.

750046971	75004697	60", Wood	1/ea.
75004697	75004697	60", Wood	12/cs.
750046991	75004699	60", Fiberglass	1/ea.
75004699	75004699	60", Fiberglass	12/cs.

E. SUPER JAWS™ MOP HANDLES PRIME SOURCE®

Extra durable nylon construction. Recommended for wide bands.

750046981	75004698	60", Fiberglass	1/ea.
75004698	75004698	60", Fiberglass	12/cs.
750046961	75004696	60", Wood	1/ea.
75004696	75004696	60", Wood	12/cs.

F. GRIPPER® WET MOP HANDLES RUBBERMAID

Gripper® wet mop handles hold mop firmly between the jaws of the mop handle. Use 5" headband mops only.

177003791	H245	54", Yellow, Fiberglass	1/ea.
17700727	H246GR00	60", Gray, Fiberglass	12/cs.
177002261	H226	60", Yellow, Aluminum	1/ea.
177008311	H216	60", Yellow, Hardwood	1/ea.
17700236	H236	60", Yellow, Vinyl-Coated Aluminum	12/cs.

G. INVADER® WET MOP HANDLE RUBBERMAID

A hinged side gate allows mops to easily slide on and off handle. A thumb wheel clamps the mop firmly in place. For use with 1" headband mops only. Plastic head.

177014601	H146GY00	60", Gray, Fiberglass	12/cs.
-----------	----------	-----------------------	--------

H. STIRRUP™ WET MOP HANDLE RUBBERMAID

Rubbermaid Stirrup™ antimicrobial handles contain Microban® B, which protects the product by inhibiting the growth of bacteria. Hinged side gate allows mop to easily slide on and off the handle. Thumb wheel clamps the mop firmly in place. Use with 1" headband.

177092261	H416	1 1/8" x 60"	1/ea.
-----------	------	--------------	-------

SPONGE MOPS

I. HEAVY-DUTY ROLLER SPONGE MOP PRIME SOURCE®

This durable sponge mop features an extra wide cellulose sponge for maximum absorption and a convenient handle-mounted lever for efficient roller wringing. Wringing is easy without having to bend over. Plated metal construction and plastic rollers assure long service.

75004758	75004758	12"W, Complete	16/cs.
75004759	75004759	12"W, Refill	16/cs.

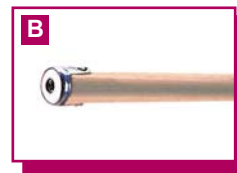

Sponge Mops/Alternative Mop/Mop Wringers



A. COMBO SPONGE MOP **CCP**
 Highly absorbent cellulose sponge mop with steel painted handle with hanger grip.
27601408 6012 12"W, Complete 12/cs.



B. STEEL SPONGE MOP/REPLACEMENT HEAD **RUBBERMAID**
 An easy-to-use cleaning system. Synthetic sponge mop heads. Handle mounted lever allows for squeeze-action wringing. Refill heads available.
17700048 6435BRNZ 12", Bronze, Complete 6/cs.
177064361 6436YEL 12", Yellow, Replacement Head 1/ea.
17706436 6436YEL 12", Yellow, Replacement Head 12/cs.



C. CLOROX READYMOP™ FLOOR CLEANING SYSTEM **CLOROX**
 Simple one-step floor cleaning system means no bucket, mop or diluting required. Hygienic, just dispose of dirty pad after cleaning. All-in-one cleaner safe for use on tile, linoleum, vinyl, marble, laminate, and sealed/finished wood floors. Ideal for quick cleaning of tracked dirt and spills between regular mopping intervals. Cleaning system with formula that is an EPA registered disinfectant.
38381285 14903 24 oz., Complete w/Cleaner & 8 Pads 4/cs.
38381287 14902 24 oz., Refill Cleaner 12/cs.
38384901 14901 8 Pads, Refill Pads Only 96/cs.
38381286 14905 16 Pads, Refill Pads Only 8/cs.



MOP WRINGERS



D. DOWN-PRESS WRINGER **CCP**
 Accommodates a wide variety of mops. Ergonomic handle design for leverage and comfort.
27600996 SW7YW 16-32 oz. Mops, Yellow 1/ea.



E. SPLASH GUARD™ SIDE-PRESS MOP WRINGER **CCP**
 Accommodates 12 to 32 oz. mops. Mop handle holder is molded into wringer front. Extended handle design for leverage and comfort. Wringer nests in bucket for economic storage and shipment. Fits Continental 26, 35, and 44 quart mop buckets.
276002251 SW12YW 12-32 oz. Mops, Yellow 1/ea.



F. BRUTE® SIDE-PRESS MOP WRINGER **RUBBERMAID**
 Sideward pressure mop wringer. Torsion spring for up to 25,000 cycles for long product life. Corrosion-resistant handles and hardware.
17700527 612701YEL 12-32 oz., Yellow 1/ea.



G. WAVEBRAKE® WRINGERS **RUBBERMAID**
Down-Press
 High efficiency downward pressure mop wringer. Wrings mop with 18% less effort. Tested to 50,000 wringing cycles. Lasts 29 times longer than comparative wringers. Corrosion-resistant handle and hardware.
17702575 757588YEL 32 oz., Yellow 1/ea.
Side-Press
 The WaveBrake® mop bucket and wringer system reduces splashing, which means a safer environment, cleaner floors, and improved productivity. High efficiency wringer for 28 and 35 qt. WaveBrake buckets. Lasts 58 times longer than comparative wringers. Tested to exceed 50,000 wringing cycles, average wringers perform approximately 860 cycles. Premium tubular steel and structural web molded plastic.
177061271 612788YEL 32 oz. Mop Max, Yellow 1/ea.

H. PAIL & MOP STRAINER COMBINATION **RUBBERMAID**
 Lightweight combo pack lets operator travel up and down stairs easily. Pail holds up to 15 qt. and strainer wrings up to a 10 oz. mop. Durable plastic construction has smooth, easy-to-clean surface. Pails and funnel-shaped mop strainers nest and stack for convenient transport and storage between jobs.
177061941 6194T 15 qt., 17" x 10½" x 12", Turquoise 1/ea.

Mop Buckets/Bucket & Wringer Combos



MOP BUCKETS

A. SPLASH GUARD™ MOP BUCKETS

CCP

Features 3" non-marking casters, embossed graduations and universal "Caution" logo.

27602263	2263YW	26 qt., Yellow	1/ea.
27609192	3353YW	35 qt., Yellow	1/ea.



B. CHARGING BUCKET

RUBBERMAID

Charging bucket boosts productivity in healthcare cleaning. Holds up to (20) microfiber wet pads, generally enough for one housekeeper for one shift using one pad per room. Ergonomic, no bending or pulling. Molded-in filling guide; 1 qt. per 5 pads. Molded-in grate prevents over-saturation. Water-tight lid. Smooth, non-porous surface helps prevent bacterial growth and cleans up easily. Buckets fit onto the #6173 janitor cart and accommodate pads up to 18" in length.

177019501	Q950	Yellow	1/ea.
-----------	------	--------	-------



C. MICROFIBER FINISH BUCKET

RUBBERMAID

Perfect for tamping excess finish from microfiber flat mops. Color-coded blue to visually differentiate use. Handle stay keeps mop upright and ready-to-use. Washboard surface effectively removes dirt and debris from mop pads before wringing. Twist-valve empties contents without lifting. Smooth, non-porous surface helps prevent bacterial growth and cleans up easily. Buckets fit onto the #6173 janitor cart and accommodate pads up to 18" in length.

17701930	Q930	Blue	1/ea.
----------	------	------	-------



D. WAVEBRAKE® DIRTY WATER BUCKET

RUBBERMAID

For 35 qt. WaveBrake® bucket (will not fit 26 qt.). Separates dirty water from clean water.

Reduces risk of cross-contamination. Easy to empty.

177093081	9C74RED	18 qt., Red	1/ea.
-----------	---------	-------------	-------



E. WAVEBRAKE® MOP BUCKETS

RUBBERMAID

The WaveBrake® mop bucket reduces splashing, which means a safer environment, cleaner floors, and improved productivity.

177075661	757088BLUE	35 qt., Blue	1/ea.
17707578	757088BRN	35 qt., Brown	1/ea.
17707570	757088YEL	35 qt., Yellow	1/ea.
17707751	7570L2	Replacement Casters, Plastic	1/ea.



BUCKET/WRINGER COMBOS

F. MOP BUCKET/WRINGER COMBOS

CCP

Side-Press Wringer

Combo pack includes a 26 qt. mop bucket with a SW1 squeeze-type wringer. 3" casters.

27601180	20631YW	26 qt., Yellow	1/ea.
----------	---------	----------------	-------

Down-Press Wringer

Mop bucket with 3" non-marking casters, embossed graduations, universal "Caution" logo, and SW7 down-press wringer.

27604042	40437YW	44 qt., Yellow	1/ea.
----------	---------	----------------	-------



G. SMOOTHLINE™ MOP BUCKET/WRINGER COMBO

CCP

Combo pack with 26 qt. bucket and SW2 side-press wringer. Non-marking 3" casters and universal "Caution" symbol.

27606636	26636YW	26 qt., Yellow	1/ea.
----------	---------	----------------	-------



Bucket/Wringer Combos



A. SPLASH GUARD™ MOP BUCKET/WRINGER COMBOS CCP

Side-Press Wringer

Combo mop bucket with SW12 side-press wringer. Generous pour spout prevents splash and spill. Hand grip at back-rear of bucket provides convenient and secure lift for emptying. Standard with 3" non-marking casters. Universal "Caution" symbol.

27600230	226312BL	26 qt., Blue	1/ea.
27602275	226312YW	26 qt., Yellow	1/ea.
27600229	335312YW	35 qt., Yellow	1/ea.

Down-Press Wringer

Combo pack includes a 35 qt. bucket and SW7 down-press wringer. International "Caution" symbol. 3" non-marking casters.

27603353	33537YW	35 qt., Yellow	1/ea.
----------	---------	----------------	-------

B. UNIBODY MOPPING SYSTEM CCP

One-piece design results in a positive transfer of force, removing more water per stroke. Includes self-draining and spigot and sediment screen drain grate.

27600221	351YW	35 qt., Yellow	1/ea.
----------	-------	----------------	-------

C. BUCKET/WRINGER COMBO PACKS RUBBERMAID

Mopping combo pack, 6118/88 mop bucket/7575 downpress wringer. Non-marking casters for reduced touch-up cleaning. Smooth, easy-to-clean surfaces.

17707574	7576BRN	44 qt., Brown	1/ea.
17707594	757688	44 qt., Yellow	1/set

D. EZMT™ BUCKET/WRINGER COMBO PACK RUBBERMAID

Mopping combo pack, 6185 mop bucket/6127-01 wringer. Non-marking casters for reduced touch-up cleaning. Smooth, easy-to-clean surfaces. EZMT™ foot activated emptying mechanism.

17706186	6186YEL	Yellow	1/ea.
----------	---------	--------	-------

E. TANDEM™ BUCKET & WRINGER COMBO RUBBERMAID

All-in-one compact design means more effective wringing, better mop performance and no more lost parts. One-piece design: Integrated bucket and wringer. Holes in both wringing plates force more water from mop in less time. Reverse-wringing mechanism for more comfortable use. Built-in lift handles on bottom of bucket make lifting and emptying easier. Accepts up to 24 oz. mops.

17707380	7380	Yellow	1/ea.
----------	------	--------	-------

F. WAVEBRAKE® BUCKET/WRINGER COMBOS RUBBERMAID

Side-Press Wringer

The WaveBrake® mop bucket and wringer system reduces splashing, which means a safer environment, cleaner floors and improved productivity. High efficiency side-press wringer. Lasts 58 times longer than comparative wringers. Tested to exceed 50,000 wringing cycles, average wringers perform approximately 860 cycles. Premium tubular steel and structural web molded plastic. Accepts optional dirty water bucket (9C74).

177074801	748018YEL	26 qt., Yellow	1/ea.
17707602	758888BLUE	35 qt., Blue	1/ea.
17707600	758088BRN	35 qt., Brown	1/ea.
17707588	758888RED	35 qt., Red	1/ea.
17707586	758088YEL	35 qt., Yellow	1/ea.

Down-Press Wringer

The WaveBrake® mop bucket and wringer system reduces splashing, which means a safer environment, cleaner floors and improved productivity. High efficiency down-press wringer. Tested to exceed 100,000 wringing cycles. Accepts optional dirty water bucket (9C74).

17707616	757788BRN	35 qt., Brown	1/ea.
17707615	757788YEL	35 qt., Yellow	1/ea.

Bucket/Wringer Combo/Finish Systems/Signage



A. WAVEBRAKE® DUAL WATER COMBO RUBBERMAID

The WaveBrake® mop bucket and wringer system reduces splashing, which means a safer environment, cleaner floors, and improved productivity. Down-press wringer tested to exceed 100,000 wringing cycles, side-press wringer performs 50,000 cycles. Premium tubular steel and structural web molded plastic. Included dirty water bucket locks into place when in use, easily removable for emptying. Bucket in bucket system separates clean and dirty water. Quiet caster dolly makes half the noise of standard mop bucket.

17707677 767700YEL 35 qt., Yellow, Down-Press Combo 1/ea.



FLOOR FINISH SYSTEMS

B. WAX APPLICATOR PRIME SOURCE®

Wax applicator includes maple block, wool pad with natural back and 54" threaded wood handle. This professional tool is designed for smooth, lint-free application of floor finish, sealers and other liquid compounds. Quality 3/4" lambs wool is wrapped around a lacquered maple block and held in place by another block with wing nuts, providing easy pad replacement. Accommodates standard threaded handles. 100% synthetic.

75004752 75004752 18", Complete 12/cs.



C. NYLON FINISH SYSTEM RUBBERMAID

Includes bucket with handle, lid, two sieves, four casters, six mop heads and frame. Helps ensure controlled absorption and release of finish. Delivers 200 to 300 sq. ft. of coverage with a single mop load of finish. Tightly-twisted rayon/synthetic blend looped-end mop absorbs and releases finish smoothly and evenly. Resealable bucket keeps finish fresh until next job, saving time and operating costs. Smooth, non-porous bucket cleans easily.

17700501 E050 22 qt., Complete Kit 1/ea.
17700520 E052 5" x 18", White/Blue Stripe, Mop Heads Only 6/cs.



FLOOR SIGNAGE

D. TRI-CONE CAUTION SIGN CCP

Cone with universal "Caution" symbol printed on three sides. Large triangular footprint for maximum stability. Nest for storage.

276001211 121YW 27"H, Yellow 1/ea.



E. WET FLOOR SIGNS CCP

Easel type wet floor sign, printed on both sides in English/Spanish/German.

276007431 119 26"H, Yellow, "Caution" 1/ea.
276007441 119C 26"H, Yellow, "Closed" 1/ea.



F. FLOOR SIGNS RUBBERMAID

Imprinted in English, French and Spanish. Two-sided model for use in narrow areas. Folding design for convenient storage.

177061121 6112 25"H, Yellow, "Caution" 1/ea.
17700340 611277 25"H, Yellow, "Caution Wet Floor" 6/cs.
177003401 611277 25"H, Yellow, "Caution Wet Floor" 1/ea.
177003591 611278 25"H, Yellow, "Closed" 6/cs.



G. OVER-THE-SPILL® STATION RUBBERMAID

Slip-resistant pads quickly cover spills and alert pedestrians. Each yellow pad is coded with universal "Caution" symbol and "Caution Wet Floor" message in English and Spanish. Station is constructed of corrugated plastic and mounts on flat surface, easily dispensing medium or large pads. Pads are constructed of melt-blown polypropylene for added strength and absorbency. Large pads absorb up to 16 oz. (0.5 kg) of fluid per pad. Medium pads absorb up to 12 oz. (0.3 kg) of fluid per pad.

177042525 4252 20"L x 16 1/2"W, Yellow, Large Refill Pads 25/cs.



Signage/Squeegees/Hand Tools



A. POP-UP SAFETY CONES RUBBERMAID

Collapsible, automatically deployed cone. Wall-mounted storage tube allows for easy and compact storing. Durable material withstands abuse. Multi-lingual message.

177062701	9S01	29"H, Yellow, "Caution" Imprint/ Wet Floor Symbol	1/ea.
17706270	9S01	29"H, Yellow, "Caution" Imprint/ Wet Floor Symbol	12/cs.



B. SAFETY CONES RUBBERMAID

Highly visible hazard protection system. Versatile top design accommodates barricade belt, flashing light and lock-in sign holder. Four-sided shape allows for efficient stacking. Molded-in slots for easy handling. Multi-lingual message.

17706280	6276	36"H, Yellow, "Caution"	5/cs.
177062761	627677	36"H, Yellow, "Caution, Wet Floor"	1/ea.
17706276	627677	36"H, Yellow, "Caution, Wet Floor"	5/cs.



C. SITE SAFETY HANGING SIGN RUBBERMAID

Sign and pole combination blocks doorway. Torsion action to secure pole. Soft, pliable sign for ease of use and storage. Multi-lingual message.

177090161	9S16	18" x 12", Yellow, "Closed for Cleaning"	1/ea.
-----------	------	--	-------



SQUEEGEES

D. WINDOW SQUEEGEE CCP

Lightweight and durable ABS plastic handle with aluminum channel. Precision cut rubber blades provide professional, streak-free performance. Handle, blade and channel is pre-assembled.

27602473	2473	14"	12/cs.
----------	------	-----	--------



E. STRAIGHT FLOOR SQUEEGEES CCP

Heavy zinc-plated metal frames with a high grade dual edge, replaceable rubber blades are designed for tapered handles. Straight squeegees feature a steel scraper edge.

276002521	2400	24"	1/ea.
27603605	3600	36"	2/cs.



HAND TOOLS

F. SCRAPERS RUBBERMAID

Heat treated carbon steel blade for maximum strength. The blade contains a polished and clear coated protectant against corrosion. Comfortable contoured handle.

17700046	9H16	1 1/2", Red	6/cs.
17700010	9H15	3", Red	6/cs.



G. RETRACTABLE UTILITY KNIVES RUBBERMAID

Optimized cutting angle for reduced fatigue. Smooth, three-position slide exposes variable blade length and increased durability for frequent use. Inside storage for five blades.

17709006	9H06	Quick Change, 6 3/4"L	1/ea.
17709007	9H07	Self-Retracting, 6 3/4"L, Red	1/ea.
17709005	9H05	Standard, 6 3/4"L, Red	1/ea.



H. BLADE DISPENSERS W/REFILLS RUBBERMAID

Blades are unbreakable under normal working conditions. Optimized cutting angle for reduced fatigue. Smooth, three-position slide exposes variable blade length and increased durability for frequent use. Inside storage for five blades. Blades stay sharp three times longer than conventional blades.

17702084	2084300	50 Blades, 1 1/8"H x 4 1/2"L, Blue	5/cs.
17708440	2084400	100 Blades, 1 1/8"H x 4 1/2"L, Blue	5/cs.

Spray Bottles/Sprayers/Pumps/Buckets/Pails



SPRAY BOTTLES/SPRAYERS/PUMPS

A. PLASTIC BOTTLES

CCP

Molded of high density polyethylene with a 28/400 neck and molded in graduations.

276091611	916CN	16 oz., Translucent, Center Neck	1/ea.
27601534	922B	22 oz., Translucent, Off-Set Neck	100/cs.
276092401	924B	24 oz., Translucent, Center Neck	1/ea.
276015471	932	32 oz., Translucent	10/cs.
27601547	932	32 oz., Translucent	100/cs.



B. PROSAFE™ SPRAYERS

CCP

These bottles come in a pack of three, have a product check-off grid and provide bilingual information to help compliance with the "Right to Know" regulations. 24 oz. bottle with 922H sprayer.

276002565	9023RW	24 oz., Red/White	3/cs.
-----------	--------	-------------------	-------



C. SPRAY-PRO™ TRIGGER SPRAYERS

CCP

Designed for heavy-duty, long-term industrial applications ranging from car care to window cleaners. Features a leak-proof nozzle capable of delivering a consistent spray pattern that is adjustable from a full "off" position to a fine, atomized mist to a powerful jet stream.

276009021	902BW9	9 3/4", Blue/White	10/cs.
276000241	902RW9	9 3/4", Red/White	1/ea.



D. PLASTIC DRUM PUMP

CCP

Fits 5 to 30 gallon drums with a 1/2" or 2" opening. Adjusts to dispense 2,4,6, or 8 oz. per stroke. Chemical and acid-resistant design.

276012951	330	10 3/4" Tube, Heavy-Duty	1/ea.
-----------	-----	--------------------------	-------



E. PUMP DISPENSER

CCP

A unique "hold-down" feature that allows the pump to be secured in the compressed position, ideal for shipping purposes. Unique threaded body disassembles quickly for sanitary cleaning. The body and head are polypropylene for maximum chemical compatibility. Use with cleaners, waxes, food products, cooking oils, hand soap, shampoo and germicidal detergents. Standard with Poly Flap Valve (HDPE). Made from FDA and USDA approved materials.

276005961	10	1 oz. Pump, 16 1/8", White	1/ea.
-----------	----	----------------------------	-------

BUCKETS/PAILS

F. HUSKEE™ BUCKETS

CCP

Features durable steel handle, built-in pour spout and graduations molded inside.

276014861	8110GY	10 qt., Gray	1/ea.
276014891	8110RD	10 qt., Red	1/ea.
276014951	8114RD	14 qt., Red	1/ea.



G. BRUTE® BUCKETS

RUBBERMAID

Heavy-duty thick wall construction. Molded-in graduations for accurate measuring.

177078601	2963GRAY	10 qt., Gray	1/ea.
17707860	2963GRAY	10 qt., Gray	12/cs.
177076841	2614GRAY	14 qt., Gray	1/ea.
17707684	2614GRAY	14 qt., Gray	6/cs.
17707686	2614RED	14 qt., Red	6/cs.



H. DOUBLE PAIL

RUBBERMAID

A double pail allows separation of cleaning solution and rinse water. Use with a roller sponge mop for an easy-to-use cleaning system.

17707692	2617GRAY	17 qt., Gray	6/cs.
----------	----------	--------------	-------



Tool Holders/Step Stools/Utility Carts



TOOL HOLDERS

A. CLOSET ORGANIZER/TOOL HOLDERS RUBBERMAID

Helps increase productivity and efficiency through better tool storage and access. S-hooks hold 5/8" to 1 1/4" handle diameters. Deep double hooks afford easy accessibility. Clip holder for notes and instructions.

177002911	1992	18"L, Gray	1/ea.
177003171	1993	34"L, Gray	1/ea.
17700317	1993	34"L, Gray	4/cs.



STEP STOOLS

B. MOBILE TWO-STEP STEP STOOLS RUBBERMAID

Heavy-duty step stool glides easily on retractable rubber casters. Supports loads up to 350 lbs. Soft, slip-resistant pads on both steps. Wheels retract when stepped on. Heavy-duty plastic construction will not damage walls or furniture.

17707630	2523BEIG	16" dia. x 13"H, Beige	1/ea.
17702521	2523BLA	16" dia. x 13"H, Black	1/ea.



C. TWO-STEP FOLDING STEP STOOL RUBBERMAID

Ideal for maintenance activities and whenever elevation assistance is needed. Slip-resistant surfaces on steps and foot pads. Stands upright when folded and requires minimum space for storage. Easy to transport. Easy to clean and resistant to dents and rust. Supports loads up to 300 lb.

177042101	420903CYLND	Cylinder	1/ea.
-----------	-------------	----------	-------



BUSSING/UTILITY CARTS

D. BUSSING CARTS CCP

Three shelf cart features 4" heavy-duty, non-marking gray casters. Applications range from industrial use to foodservice and bussing. Accepts the 5811 and 5812 silverware and refuse bins. Supports 200 lbs.

27605810	5810BE	Beige	1/ea.
27605811	5810BK	Black	1/ea.



E. UTILITY CARTS CCP

Utility carts features 5" heavy-duty, non-marking gray casters for industrial use. Supports 200 lbs. per shelf (400 lbs. max capacity). Optional center shelf available.

27601378	5800GY	34 3/8" x 17 1/2" x 33"H, Gray	1/ea.
27600346	5805BE	40 3/8" x 25 1/2" x 33"H, Beige	1/ea.
27600345	5805GY	40 3/8" x 25 1/2" x 33"H, Gray	1/ea.



F. FLAT SHELF UTILITY CART RUBBERMAID

Versatile flat shelves designed for transport of oversized, bulky items. Makes a convenient mobile work surface for folding, sorting or repairing. Sturdy structural foam construction won't rust, dent, chip or peel. All-plastic design provides easy maintenance and quiet operation. Large, non-marking casters reduce touch-up cleaning. Ideal for general factory, health care, retail, foodservice, and office use. Optional middle shelf available.

17700526	4505BLA	500 lb., 37 7/8"L x 19 1/2"W x 33 3/8"H, Black	1/ea.
----------	---------	--	-------



G. SHELF CART RUBBERMAID

Molded one-handle carts are made of tough Duramold® plastic. Leakproof top. 32 1/4" high. Includes two rigid and two swivel 5" casters. Carries 400 lb. loads. Optional middle shelves (order separately).

17704500	4500BEIG	39 1/4"L x 17 7/8"W x 33 1/4"H, Beige	1/ea.
----------	----------	---------------------------------------	-------



H. UTILITY CART RUBBERMAID

Utility cart with enclosed end panels. Easy-to-clean smooth surfaces. Quiet 4" casters and plastic construction help eliminate noise. User-friendly handles on each end enhances mobility. Structural foam construction. Molded-in storage compartment on top shelf.

17700080	335588	300 lb., 31"L x 18"W x 37 1/2"H, Platinum	1/ea.
----------	--------	---	-------

Utility, Janitor & Equipment Carts



A. X-TRA™ UTILITY CARTS - 300 LBS. RUBBERMAID

Durable and attractive open-sided carts are sized to carry large loads. Large shelves hold various equipment and supplies. Capacity is 100 lbs. per shelf.

17704091	<i>4091GRAY</i>	3-Shelf, 40 ⁵ / ₈ "L x 20"W x 37 ¹³ / ₁₆ "H, Gray	1/ea.
17704097	<i>4096BLA</i>	4-Shelf, 40 ⁵ / ₈ "L x 20"W x 51"H, Black	1/ea.



B. 2-SHELF UTILITY CARTS RUBBERMAID

Perfect for transporting equipment and heavy loads in any environment. Sturdy structural foam construction won't rust, dent, chip or peel. Rounded corners protect walls and furniture. Lightweight and maneuverable. Large, non-marking casters. Optional middle shelf available.

17700090	<i>450088BLA</i>	500 lb., 39 ¹ / ₄ "L x 17 ⁷ / ₈ "W x 33 ¹ / ₄ "H, Black	1/ea.
17702093	<i>452088BLA</i>	500 lb., 45 ¹ / ₄ "L x 25 ⁷ / ₈ "W x 33 ¹ / ₄ "H, Black	1/ea.



CLEANING/JANITOR/EQUIPMENT CARTS

C. X-TRA™ HOUSEKEEPING CART RUBBERMAID

Compact housekeeping cart with vinyl bag, bumpers and vacuum holder. Commercial grade molded construction with 8" non-marking wheels and locking brakes.

17706190	<i>6190</i>	49"L x 22"W x 50"H, Compact	1/ea.
-----------------	-------------	-----------------------------	-------

D. JANITOR CARTS CCP

Accommodates a 26 or 35 qt. mop bucket with wringer. Heavy-duty, 25 gal. zippered vinyl bag. Non-marking 8" rear wheels, 3" ball-bearing swivel front casters. Vinyl bag replacement and locking compartment available. Two optional locking compartments.

27601140	<i>184BL</i>	55" x 30" x 38", Blue	1/ea.
27601142	<i>184GY</i>	55" x 30" x 38", Gray	1/ea.



E. CLEANING CART W/VINYL BAG RUBBERMAID

Smooth, easy-to-clean surface. Zippered bag for easy trash removal. Non-marking 8" wheels and 4" casters. Optional locking compartment.

17706174	<i>6173BLUE</i>	21 ³ / ₄ "W x 46"L x 38 ³ / ₈ "H, Blue	1/ea.
-----------------	-----------------	--	-------



F. HIGH CAPACITY CLEANING CART/BAG RUBBERMAID

Flexible, high capacity storage solutions and tool organization. Lock 'N Go bucket attachment. Rubber tool holders, four in front and one in back. Two removable 10 qt. six bottle caddies. Non-rusting and easy cleaning aluminum and structural web plastic construction. Comfort Grip cart handles. Lobby dust pan/vacuum holder. Four safety sign holders. 4" casters and 8" wheels. 5 cu. ft. of storage space.

17709097	<i>9T72</i>	49 ³ / ₄ "L x 38 ³ / ₈ "H x 21 ³ / ₄ "W, Black	1/ea.
17709078	<i>9T80</i>	Cart Bag, 33"L x 17 ¹ / ₂ "H x 10 ¹ / ₂ "W, Yellow	2/cs.



G. HIGH SECURITY JANITOR CART RUBBERMAID

A complete system solution optimized for cleaning in healthcare facilities. Designed for use with all RCP microfiber products. Large 7¹/₄ cu. ft. of locking cabinet area. 5 cu. ft. of storage space. Features Lock 'N Go bucket attachment. Rubber tool grips hold handles upright. Features 4" quiet casters and 8" wheels. Locking cabinet doors on both sides of cart. Includes two removable 10 qt. disinfecting caddies. Non-rusting and easy-to-clean aluminum and structural web plastic construction. Comfort Grip cart handle provides easy maneuverability and includes lobby dust pan/vacuum holder. Hooks hold up to four safety signs.

17709103	<i>9T75</i>	22"W x 48 ¹ / ₄ "L x 53 ¹ / ₂ "H, Black	1/ea.
-----------------	-------------	---	-------



Janitor & Equipment Carts/Maid Caddies



A. LOCKING JANITOR CART CABINET **RUBBERMAID**
 Locking janitor cart cabinet. Fits 6173 and 6173-02 carts.
17706181 6181 20"L x 16"W x 11 1/4"H, Yellow 1/ea.



B. MOBILE WORK CENTER **RUBBERMAID**
 Five drawer mobile work center. The heavy-duty work surface supports up to 250 lbs. The built in cord wrap allows neat and convenient storage of power tools and work lights. Casters provide portability and are lockable for safety. Locking bar provides security and holds drawers securely in place.
17703488 773488 32 5/8"L x 19 13/16" x 33 1/2"H, Black 1/ea.



C. TRADES CART **RUBBERMAID**
 Four compartmentalized boxes store assorted parts and hardware. Fully enclosed, lockable storage compartment helps keep tools and materials secure. Two storage bins hold essential hand tools and supplies. Carts move easily over hard surfaces, through elevators and doorways. Flat surface at ergonomic height provides convenient work area. 180 lb. top shelf/150 lb. bottom shelf.
17706180 6180 38" x 19 1/4" x 33 3/8", Black 1/ea.



D. X-TRA™ INSTRUMENT CART **RUBBERMAID**
 Smooth, easy-to-clean shelves. Lockable doors secure contents. Sliding top drawer. Easy pound-together assembly. Large, non-marking casters.
17700581 4094 300 lb., 40 5/8" x 20" x 37 13/16", Gray 1/ea.



E. X-TRA™ EQUIPMENT CART **RUBBERMAID**
 Equipment cart. Sized to carry large loads so you can reduce return trips. Large shelves hold various equipment and supplies. Holds 100 lbs. per shelf. Attractive styling ideal for front of house use.
17704095 4095BLA 300 lb., 40 5/8"L x 20 3/4"W x 37 7/8"H, Black 1/ea.



F. LADDER CART W/CABINET **RUBBERMAID**
 Ladder cart provides greater mobility, enhanced access, safe ladder handling, and minimal storage requirements. Commercial-grade hybrid construction of powder-coated steel and Rubbermaid structural foam. Compact footprint increases maneuverability, requires minimal storage space. Safely carries a 6' ladder without hitting doorways, walls or elevators. Tall profile improves access and offers a more comfortable work height. Fully adaptable to work site requirements, with long-item storage, tool holders and locking cabinets.
17700016 9758 500 lb., 42"H x 27"W x 31 1/2"L, Black/Red 1/ea.



MAID CADDIES

G. HUSKEE™ MAID CADDY **CCP**
 Handy accessory has a convenient handle to raise and carry or collapse out of the way. Fits round or square Huskee™ receptacles and the 50 gal. Tilt 'n Wheel.
276012671 3155 5" x 9 3/4" x 16 1/2", Gray 1/ea.



H. STANDARD MAID CADDY **CCP**
 Made of seamless high impact plastic. Fits most hotel and janitor carts.
276000481 48 5 1/4" x 16" x 11", Gray 1/ea.



I. MAID CADDY **RUBBERMAID**
 All purpose caddy is perfect for carrying tools or cleaning supplies for touch-up maintenance. Snaps securely onto Brute® rim (44 gal.), #2643.
177077561 2649GRAY 16" x 9" x 5", Gray 1/ea.

Can Liners



CAN LINERS

A. HIGH DENSITY CAN LINERS PRIME SOURCE®

High Density Liners (HDPE)

7500092	7500092	12-16 gal., 19" x 25", Clear, 0.7 MIC	1M/cs.
76004256	76004256	20-30 gal., 30" x 37", 8 MIC	500/cs.
76006062	76006062	40-45 gal., 40" x 48", Black, 22 MIC	150/cs.
76006064	76006064	40-45 gal., 40" x 48", Natural, 22 MIC	150/cs.
76000456	76000456	40-45 gal., 43" x 48", Black, 16 MIC	200/cs.
76000795	76000795	55 gal., 38" x 57", Black, 20 MIC	150/cs.

High Density - Flat Packs

75001038	75001038	12-16 gal., 24" x 33", Clear, 6 MIC	1M/cs.
75001035	75001035	33 gal., 33" x 40", Clear, 16 MIC	250/cs.
75001028	75001028	55 gal., 38" x 60", Clear, 16 MIC	200/cs.

High Density - Coreless Rolls

76004251	76004251	4 gal., 17" x 18", Natural, 6 MIC	2M/cs.
75004856	75004856	7-10 gal., 23" x 24", Black, 6 MIC	1M/cs.
75004855	75004855	7-10 gal., 23" x 24", Natural, 5 MIC	1M/cs.
76006007	76006007	12-16 gal., 23" x 33", Black, 8 MIC	1M/cs.
75004857	75004857	12-16 gal., 24" x 33", Natural, 6 MIC	1M/cs.
75004858	75004858	12-16 gal., 24" x 33", Natural, 7 MIC	1M/cs.
76004258	76004258	20-30 gal., 30" x 36", Black, 13 MIC	250/cs.
75004860	75004860	20-30 gal., 30" x 36", Natural, 9 MIC	500/cs.
75004861	75004861	20-30 gal., 30" x 36", Natural, 11 MIC	500/cs.
75004862	75004862	20-30 gal., 30" x 36", Natural, 13 MIC	250/cs.
75004863	75004863	20-30 gal., 30" x 36", Natural, 15 MIC	250/cs.
75001037	75001037	20-30 gal., 30" x 37", Clear, 10 MIC	500/cs.
75004811	75004811	20-30 gal., 30" x 37", White, 17 MIC	200/cs.
75004867	75004867	33 gal., 33" x 39", Natural, 13 MIC	250/cs.
75000095	75000095	33 gal., 33" x 40", Black, 13 MIC	250/cs.
75001043	75001043	33 gal., 33" x 40", Black, 22 MIC	250/cs.
75001036	75001036	33 gal., 33" x 40", Clear, 12 MIC	500/cs.
75004866	75004866	33 gal., 33" x 40", Natural, 11 MIC	250/cs.
75004869	75004869	33 gal., 33" x 40", Natural, 15 MIC	250/cs.
75004814	75004814	33 gal., 33" x 40", White, 17 MIC	150/cs.
76000680	76000680	33 gal., 36" x 40", Black, 16 MIC	250/cs.
75004881	75004881	40-45 gal., 40" x 46", Black, 11 MIC	250/cs.
76004043	76004043	40-45 gal., 40" x 46", Black, 15 MIC	250/cs.
76000650	76000650	40-45 gal., 40" x 46", Black, 20 MIC	150/cs.
75004880	75004880	40-45 gal., 40" x 46", Natural, 11 MIC	250/cs.
75004865	75004865	40-45 gal., 40" x 46", Natural, 14.5 MIC	250/cs.

HIGH DENSITY CAN LINERS (CONT.) PRIME SOURCE®

High Density - Coreless Rolls (Cont.)

75004884	75004884	40-45 gal., 40" x 46", Natural, 15 MIC	250/cs.
75004885	75004885	40-45 gal., 40" x 46", Natural, 20 MIC	150/cs.
75001033	75001033	40-45 gal., 40" x 48", Clear, 14 MIC	250/cs.
75001032	75001032	40-45 gal., 40" x 48", Clear, 16 MIC	250/cs.
76000951	76000951	40-45 gal., 40" x 48", Natural, 10 MIC	250/cs.
75004882	75004882	40-45 gal., 40" x 48", Natural, 13 MIC	250/cs.
75001094	75001094	40-45 gal., 40" x 48", Natural, 16 MIC	250/cs.
76004247	76004247	40-45 gal., 42" x 47", Black, 15 MIC	200/cs.
76004250	76004250	40-45 gal., 42" x 47", Black, 20 MIC	150/cs.
75004888	75004888	40-45 gal., 42" x 47", Natural, 13 MIC	200/cs.
75004890	75004890	40-45 gal., 42" x 47", Natural, 20 MIC	150/cs.
75001030	75001030	40-45 gal., 43" x 48", Clear, 14 MIC	250/cs.
75001027	75001027	40-45 gal., 43" x 48", Clear, 17 MIC	200/cs.
75004889	75004889	40-45 gal., 43" x 48", Natural, 15 MIC	200/cs.
75001090	75001090	40-45 gal., 43" x 48", Natural, 16 MIC	200/cs.
76000950	76000950	55 gal., 36" x 60", Natural, 10 MIC	200/cs.
75004876	75004876	55 gal., 38" x 57", Black, 15 MIC	200/cs.
75004874	75004874	55 gal., 38" x 57", Natural, 20 MIC	150/cs.
75001029	75001029	55 gal., 38" x 60", Clear, 14 MIC	200/cs.
75001074	75001074	55 gal., 38" x 60", Natural, 13 MIC	200/cs.
75004872	75004872	55 gal., 38" x 60", Natural, 13 MIC	200/cs.
75004873	75004873	55 gal., 38" x 60", Natural, 15 MIC	200/cs.
75001095	75001095	55 gal., 38" x 60", Natural, 17 MIC	200/cs.

Hi-Valu High Density - Coreless Rolls

73006300	73006300	10 gal., 24" x 24", Natural, 6 MIC	1000/cs.
75004806	75004806	12-16 gal., 24" x 33", Black, 12 MIC	500/cs.
73006304	73006304	12-16 gal., 24" x 33", Natural, 6 MIC	1000/cs.
73006310	73006310	20-30 gal., 30" x 37", Natural, 10 MIC	500/cs.
73006314	73006314	20-30 gal., 30" x 37", Natural, 16 MIC	500/cs.
73006322	73006322	31-33 gal., 33" x 40", Natural, 16 MIC	250/cs.
75004813	75004813	33 gal., 33" x 40", Black, 18 MIC	250/cs.
73006363	73006363	40-45 gal., 40" x 48", Black, 16 MIC	250/cs.
73006338	73006338	40-45 gal., 40" x 48", Natural, 12 MIC	250/cs.
73006340	73006340	40-45 gal., 40" x 48", Natural, 14 MIC	250/cs.
73006362	73006362	40-45 gal., 40" x 48", Natural, 16 MIC	250/cs.
73006358	73006358	40-45 gal., 40" x 48", Natural, 22 MIC	150/cs.
75004828	75004828	40-45 gal., 42" x 46", White, 17 MIC	100/cs.
75004820	75004820	55 gal., 38" x 60", White, 17 MIC	100/cs.
73006344	73006344	56 gal., 43" x 48", Natural, 12 MIC	200/cs.
73006364	73006364	56 gal., 43" x 48", Natural, 16 MIC	200/cs.
73006360	73006360	56 gal., 43" x 48", Natural, 22 MIC	150/cs.
73006334	73006334	60 gal., 38" x 60", Natural, 14 MIC	200/cs.
73006332	73006332	60 gal., 38" x 60", Natural, 14 MIC	200/cs.
73006356	73006356	60 gal., 38" x 60", Natural, 22 MIC	150/cs.

Can Liners



CAN LINERS & CONTAINERS

A. LOW DENSITY CAN LINERS) PRIME SOURCE®

Linear Low Density Liners (LLDPE)

76000365	76000365	4 gal., 17" x 17", Black, 0.34 MIL	1M/cs.
76000366	76000366	7 gal., 20" x 21", Black, 0.34 MIL	1M/cs.
76004264	76004264	7-10 gal., 24" x 23", Black, 0.90 MIL	250/cs.
76000453	76000453	12-16 gal., 24" x 32", White, 0.45 MIL	500/cs.
76000375	76000375	12-16 gal., 24" x 32", Black, 0.45 MIL	500/cs.
76000465	76000465	12-16 gal., 24" x 32", Clear, 0.65 MIL	250/cs.
76000464	76000464	12-16 gal., 24" x 32", White, 0.65 MIL	200/cs.
76000454	76000454	20-30 gal., 30" x 36", Brown, 0.48 MIL	250/cs.
76004266	76004266	20-30 gal., 30" x 36", Black, 1.10 MIL	200/cs.
76000467	76000467	20-30 gal., 30" x 37", Clear, 0.80 MIL	100/cs.
76000380	76000380	33 gal., 33" x 39", Black, 1.10 MIL	150/cs.
76000460	76000460	33 gal., 33" x 39", Brown, 0.45 MIL	250/cs.
75000104	75000104	33 gal., 33" x 39", Gray, 1.30 MIL	100/cs.
76000446	76000446	40-45 gal., 40" x 46", Black, 1.10 MIL	100/cs.
75000097	75000097	40-45 gal., 43" x 49", Silver, 2 MIL	50/cs.
76000461	76000461	55 gal., 36" x 58", Brown, 0.60 MIL	100/cs.
76000447	76000447	55 gal., 38" x 58", Black, 1.10 MIL	100/cs.
76000466	76000466	55 gal., 36" x 58", Clear, 0.65 MIL	100/cs.
76000475	76000475	55 gal., 38" x 58", Clear, 1.10 MIL	100/cs.
76000450	76000450	56 gal., 43" x 47", White, 0.75 MIL	100/cs.
76000006	76000006	65 gal., 50" x 48", Black, 1.70 MIL	100/cs.

Linear Low Density - Flat Packs

76000455	76000455	20-30 gal., 30" x 36", White, 0.75 MIL	200/cs.
75001255	75001255	20-30 gal., 30" x 37", Black, 1 MIL	250/cs.
76000020	76000020	33 gal., 28" x 48", Gray, 1.40 MIL	200/cs.
75001234	75001234	33 gal., 28" x 48", Gray, 1.40 MIL	200/cs.
76000463	76000463	33 gal., 33" x 39", White, 0.75 MIL	150/cs.
75001257	75001257	33 gal., 33" x 40", Black, 1 MIL	250/cs.
75001258	75001258	33 gal., 33" x 40", Black, 1.50 MIL	100/cs.
75001183	75001183	33 gal., 33" x 40", Natural, 0.35 MIL	500/cs.
75001166	75001166	40-45 gal., 40" x 46", Clear, 1.50 MIL	100/cs.
76000449	76000449	40-45 gal., 40" x 46", White, 0.75 MIL	100/cs.
75001266	75001266	40-45 gal., 40" x 48", Black, 1 MIL	100/cs.
75001267	75001267	40-45 gal., 40" x 48", Black, 1.25 MIL	100/cs.
75001268	75001268	40-45 gal., 40" x 48", Black, 1.50 MIL	100/cs.
75001269	75001269	40-45 gal., 40" x 48", Black, 2.0 MIL	100/cs.
75001169	75001169	40-45 gal., 43" x 47", Black, 1.20 MIL	100/cs.
75001248	75001248	40-45 gal., 43" x 47", Clear, 1.20 MIL	100/cs.
75001275	75001275	40-45 gal., 43" x 49", Black, 0.65 MIL	100/cs.
75001173	75001173	50 gal., 45" x 52", Black, 0.90 MIL	100/cs.
75001048	75001048	55 gal., 22" x 16" x 58", Black, .60 GA	250/cs.
75001261	75001261	55 gal., 36" x 60", Black, 1.25 MIL	100/cs.
75001262	75001262	55 gal., 36" x 60", Black, 1.50 MIL	100/cs.
75001005	75001005	55 gal., 38" x 58", Black, 1.50 MIL	100/cs.
75001223	75001223	55 gal., 38" x 58", Black, 1.50 MIL	100/cs.
76000476	76000476	55 gal., 38" x 58", Clear, 1.30 MIL	100/cs.

LOW DENSITY CAN LINERS (CONT.) PRIME SOURCE®

Linear Low Density - Flat Packs (Cont.)

75001124	75001124	55 gal., 38" x 58", Gray, 1.30 MIL	100/cs.
75001155	75001155	55 gal., 38" x 58", Clear, 1.50 MIL	100/cs.
76000462	76000462	55 gal., 38" x 58", White, 0.75 MIL	100/cs.
75001281	75001281	55 gal., 38" x 60", Clear, 0.90 MIL	100/cs.
75001277	75001277	55 gal., 38" x 60", White, 0.74 MIL	100/cs.
75001235	75001235	55 gal., 39" x 56", Gray, 1.70 MIL	50/cs.
75001271	75001271	56 gal., 42 1/2" x 49", Black, 1 MIL	100/cs.
75001272	75001272	56 gal., 42 1/2" x 49", Black, 1.50 MIL	100/cs.
76000452	76000452	56 gal., 43" x 47", Black, 1.10 MIL	100/cs.
75001265	75001265	60 gal., 38" x 60", Black, 1 MIL	100/cs.
75001263	75001263	60 gal., 38" x 60", Black, 1.50 MIL	100/cs.
75001264	75001264	60 gal., 38" x 60", Black, 2.0 MIL	100/cs.

Hi-Valu Linear Low Density - Flat Packs

Economical heavy-gauge liners made from reprocessed resins. Extra heavy-duty for tough trash applications. 25/roll.

73006373	73006373	33 gal., 33" x 39", 1.5 MIL	100/cs.
73006372	73006372	33 gal., 33" x 39", 2.0 MIL	100/cs.
73006377	73006377	40-45 gal., 40" x 46", 1.5 MIL	100/cs.
73006376	73006376	40-45 gal., 40" x 46", 2.0 MIL	100/cs.
73006379	73006379	56 gal., 43" x 47", 1.5 MIL	100/cs.
73006378	73006378	56 gal., 43" x 47", 2.0 MIL	100/cs.
73006375	73006375	60 gal., 38" x 58", 1.5 MIL	100/cs.
73006374	73006374	60 gal., 38" x 58", 2.0 MIL	100/cs.

Linear Low Density - Coreless Rolls

76000876	76000876	12-16 gal., 24" x 14" x 27", Clear, 1.30 MIL	300/cs.
75001025	75001025	12-16 gal., 24" x 23", Clear, 0.40 MIL	500/cs.
75001088	75001088	12-16 gal., 24" x 24", Natural, 0.80 MIL	1M/cs.
75001023	75001023	12-16 gal., 24" x 32", Black, 0.55 MIL	500/cs.
75004807	75004807	12-16 gal., 24" x 32", White, 0.70 MIL	500/cs.
76004102	76004102	12-16 gal., 24" x 33", Black, 0.36 MIL	1M/cs.
75001083	75001083	12-16 gal., 24" x 33", White, 0.65 MIL	500/cs.
76004105	76004105	20-30 gal., 30" x 36", Black, 0.59 MIL	250/cs.
76004265	76004265	20-30 gal., 30" x 36", Black, 0.90 MIL	200/cs.
76004104	76004104	20-30 gal., 30" x 37", Black	500/cs.
76004106	76004106	33 gal., 33" x 39", Black, 0.50 MIL	250/cs.
75001021	75001021	33 gal., 33" x 39", Black, 1 MIL	250/cs.
76004269	76004269	33 gal., 33" x 39", Black, 1.10 MIL	100/cs.
76004270	76004270	33 gal., 33" x 39", Black, 1.30 MIL	100/cs.
75001019	75001019	33 gal., 33" x 39", Black, 1.50 MIL	250/cs.
76004272	76004272	33 gal., 33" x 39", Black, 1.70 MIL	100/cs.
75001200	75001200	33 gal., 33" x 40", Natural, 0.51 MIL	500/cs.

Can Liners



A. LOW DENSITY CAN LINERS (CONT.) PRIME SOURCE®

Linear Low Density - Coreless Rolls (Cont.)

75004827	75004827	40-45 gal., 39" x 46", White, 0.70 MIL	100/cs.
76004273	76004273	40-45 gal., 40" x 46", Black, 0.90 MIL	100/cs.
75001015	75001015	40-45 gal., 40" x 46", Black, 1.0 MIL	100/cs.
76004274	76004274	40-45 gal., 40" x 46", Black, 1.10 MIL	100/cs.
75001014	75001014	40-45 gal., 40" x 46", Black, 1.25 MIL	150/cs.
76004275	76004275	40-45 gal., 40" x 46", Black, 1.30 MIL	100/cs.
75001013	75001013	40-45 gal., 40" x 46", Black, 1.50 MIL	100/cs.
76004277	76004277	40-45 gal., 40" x 46", Black, 1.70 MIL	100/cs.
75001012	75001012	40-45 gal., 40" x 46", Black, 2.0 MIL	100/cs.
76004111	76004111	40-45 gal., 40" x 48", Black	250/cs.
75001242	75001242	40-45 gal., 40" x 48", Black, 0.63 MIL	250/cs.
76004279	76004279	40-45 gal., 42" x 47", Black, 0.90 MIL	100/cs.
76004280	76004280	40-45 gal., 42" x 47", Black, 1.10 MIL	100/cs.
76004281	76004281	40-45 gal., 42" x 47", Black, 1.30 MIL	100/cs.
76004283	76004283	40-45 gal., 42" x 47", Black, 1.70 MIL	100/cs.
75001002	75001002	40-45 gal., 43" x 47", Black, 1.80 MIL	100/cs.
75001244	75001244	40-45 gal., 43" x 48", Natural, 0.63 MIL	200/cs.
75001284	75001284	55 gal., 34" x 48", Gray, 1.0 MIL	100/cs.
76004287	76004287	55 gal., 36" x 58", Black, 1.30 MIL	100/cs.
75001008	75001008	55 gal., 36" x 58", Black, 1.50 MIL	100/cs.
76004289	76004289	55 gal., 36" x 58", Black, 1.70 MIL	100/cs.
75001007	75001007	55 gal., 36" x 60", Clear, 2.0 MIL	100/cs.
76004291	76004291	55 gal., 38" x 58", Black, 0.90 MIL	100/cs.
76004120	76004120	55 gal., 38" x 58", Black, 1.10 MIL	100/cs.
76004292	76004292	55 gal., 38" x 58", Black, 1.30 MIL	100/cs.
76004293	76004293	55 gal., 38" x 58", Black, 1.30 MIL	100/cs.
76004295	76004295	55 gal., 38" x 58", Black, 1.70 MIL	100/cs.
75001004	75001004	55 gal., 38" x 58", Black, 2.0 MIL	100/cs.
75001204	75001204	55 gal., 38" x 60", Black, 0.87 MIL	150/cs.
75001203	75001203	55 gal., 38" x 60", Natural, 0.63 MIL	200/cs.
76004650	76004650	55 gal., 46" x 50", Black, 1.25 MIL	100/cs.
76000490	76000490	55-60 gal., 38" x 58", Black, 2.0 MIL	100/cs.

Hi-Valu Linear Low Density - Coreless Rolls

73006368	73006368	12-16 gal., 25/Roll, 24" x 32", 1.0 MIL	150/cs.
73006369	73006369	33 gal., 25/Roll, 33" x 39", 1.2 MIL	500/cs.
73006371	73006371	40-45 gal., 25/Roll, 40" x 46", 1.2 MIL	100/cs.
73006370	73006370	60 gal., 25/Roll, 38" x 58", 1.2 MIL	100/cs.

Wet Bag Can Liners

Linear low density.

75001765	75001765	1/2 gal., 6" x 4" x 14", White	1M/cs.
----------	----------	--------------------------------	--------

B. GLAD® LINERS

CLOROX

Can Liners

Number one trash disposable brand in retail. Number one consumer recognized brand in trash category. Available in a variety of closure types; drawstring, handle-tie, and quick-tie.

38381275 61024 13 gal., 24" x 28", White 100/cs.

Drawstring Trash Bags

Patented three-layer drawstring: Strong and dependable for quick and easy closing. Easy-to-open, easy-to-close. Even the fullest bags can be closed with one easy cinch. Easy-to-lift and carry. Transport bag with ease. Strong and sturdy. Avoid messy trash disasters. Use as a laundry bag, organize sports equipment and toys, cover patio furniture, line your cat litter box, store holiday decorations and protect blankets, linens and sweaters. Not recommended for food storage.

38380313 70313 30 gal., 30" x 34", 1.1 MIL 90/cs.

38380028 70028 39 gal., 33" x 41", 1.1 MIL 144/cs.

Forceflex® Can Liners

Only Glad® has the Stretchable Strength of ForceFlex. The bag stretches to prevent punctures and rips. Unique diamond texture stretches around objects. No clumsy twist ties needed since they use an easy-open/close drawstring. Not recommended for food storage.

38380355 70355 13 gal., 24" x 28" Tall, White, .90 MIL 6/cs.

38380427 70427 13 gal., 24" x 28" Tall, White, .90 MIL 100/cs.

38380358 70358 30 gal., 30" x 33", Black, .90 MIL 70/cs.

38380359 70359 30 gal., 76¹/₈" x 81¹/₈" x 26⁷/₁₆", Black, 1.05 MIL 150/cs.

Handle-Tie® Tall Kitchen Bag

Glad® ForceFlex® bags use a proprietary plastic technology known as SELFING (Structurally Elastic-Like Film.) The plastic is deeply embossed with a diamond-like pattern that gives the material unique elasticity. Pressure is diverted away from the point of impact so that the trash bag will absorb force and stretch instead of breaking.

38380019 70034 12-16 gal., Tall, 0.74 MIL 144/cs.

Can Liners



A - B



C



CAN LINERS & CONTAINERS

A. HI-D TUFF® CAN LINERS FORTUNE PLASTICS

Flat Folded

Suitable for paper waste and can handle a wet and heavy load.

13800595	HDN2424R	10 gal., 24" x 24", Natural, 6 MIC	1000/cs.
13800600	HDN2433R	15 gal., 24" x 33", Natural, 6 MIC	1000/cs.
13800645	HDN3037R	30 gal., 30" x 37", Natural, 8 MIC	500/cs.
13800640	HDN3037M	30 gal., 30" x 37", Natural, 10 MIC	500/cs.
13800603	HDN3340M	33 gal., 33" x 40", Natural, 9 MIC	500/cs.
13800607	HDN3340X	33 gal., 33" x 40", Natural, 16 MIC	250/cs.
13800834	HDN374612	44 gal., 37" x 46", Clear, 12 MIC	250/cs.
13800610	HDN4048M	45 gal., 40" x 48", Natural, 10 MIC	250/cs.
13800615	HDN4048X	45 gal., 40" x 48", Natural, 16 MIC	250/cs.
13800360	HDN3660H	55 gal., 36" x 60", Natural, 13 MIC	200/cs.
13800129	HDN4348H	56 gal., 43" x 48", Natural, 14 MIC	200/cs.
13800620	HDN4348X	56 gal., 43" x 48", Natural, 17 MIC	200/cs.
13800650	HDN3860H	60 gal., 38" x 60", Natural, 14 MIC	200/cs.
13800655	HDN3860X	60 gal., 38" x 60", Natural, 17 MIC	200/cs.

Coreless Rolls

High density. Coreless roll, innovative, easily dispensed, ideal for portion control, time saving, cost effective.

13800195	CRHD2022	3½ gal., 20" x 22", Natural	2000/cs.
13802424	CRHD2424R	10 gal., 24" x 24", Natural, 6 MIC	20/50/cs.
13800491	CRHD2433H	15 gal., 24" x 33", Clear, 8 MIC	1000/cs.
13800266	CRHD2433H	15 gal., 24" x 33", Clear, 8 MIC	1000/cs.
13800065	CRHD2433R	15 gal., 24" x 33", Natural, 6 MIC	20/50/cs.
13800191	CRHD3037M	20-30 gal., 30" x 37", Natural, 10 MIC	500/cs.
13800104	CRHD3037H	20-30 gal., 30" x 37", Natural, 13 MIC	20/25/cs.
13800033	CRHD3340X	33 gal., 33" x 40", Natural, 16 MIC	10/25/cs.
13800712	CRHD3660H	60 gal., 36" x 60", Clear, 13 MIC	200/cs.
13800038	CRHD3860H	60 gal., 38" x 60", Natural, 13 MIC	8/25/cs.
13800067	CRHD3860X	60 gal., 38" x 60", Natural, 16 MIC	200/cs.
13804048	CRHD4048H	40-45 gal., 40" x 48", Natural, 13 MIC	10/25/cs.
13800192	CRHD4048X	40-45 gal., 40" x 48", Natural, 16 MIC	250/cs.
13800525	CRHD4048XH	40-45 gal., 40" x 48", Natural, 22 MIC	26/6/cs.
13800066	CRHD4348X	56 gal., 43" x 48", Natural, 16 MIC	8/25/cs.
13800606	HCXL6017FP	60 gal., 36" x 60", Clear, 17 MIC	6/25/cs.

Enviroplas® Can Liners - Coreless Rolls

50% recycled high density trash can liner on a coreless roll.

13800291	BCRHD4048X	40 gal., 40" x 48", Black, 16 MIC	250/cs.
----------	------------	-----------------------------------	---------

B. HIGH DENSITY CAN LINERS FORTUNE PLASTICS

Flat Packs

13802421	SL4048125	40-45 gal., 40" x 48", Clear, 15 MIC	125/cs.
13802422	SL4650MDB	60 gal., 24" x 22" x 50", Brown	100/cs.
13805040	5040CLR	65 gal., 50" x 40", Clear	150/cs.

Drum

Extra heavy-duty drum liners.

13800695	DL386318CLR	60 gal., 38" x 63", Clear, 1.8 MIL	75/rl.
----------	-------------	------------------------------------	--------

Hi-Valu

High density liners (HDPE).

13804017	HVLG334016N	33 gal., 33" x 40", Natural, 16 MIC	250/cs.
----------	-------------	-------------------------------------	---------

C. LINEAR LOW DENSITY LINERS FORTUNE PLASTICS

Flat Packs

13800237	PG65251FP	24" x 26" x 43", Black, 1 MIL	100/cs.
13804456	4456XXGR	30" x 14" x 56", Gray, 1.5 MIL	100/cs.
13803817	3858175YEL	55-60 gal., 38" x 58", Yellow, 1.75 MIL	50/cs.

Coreless Rolls

13803248	CRLD33HB	15 gal., 24" x 32", Black, 0.70 MIL	500/cs.
13803241	CRLD33RW	15 gal., 24" x 32", White, 0.45 MIL	500/cs.
13803242	CRLD37HW	30 gal., 30" x 36", White, 0.70 MIL	200/cs.
13803243	CRLD40HW	33 gal., 33" x 39", White, 0.70 MIL	150/cs.
13803245	CRLD46HW	40-45 gal., 40" x 46", White, 0.70 MIL	100/cs.
13801882	CRLD60HB	55-60 gal., 38" x 58", Black, 0.75 MIL	200/cs.
13803244	CRLD60HW	55-60 gal., 38" x 58", White, 0.75 MIL	100/cs.

Can Liners



A. DURALINER® LINEAR LOW DENSITY LINERS FORTUNE PLASTICS

Gold Label Can Liner

Strong liners for industrial use.

13800278 BK348GO 56 gal., 43" x 47", Black, 2 MIL 100/cs.

Gold Survivor Trash Can Liner

Suitable for paper waste. Can handle wet and/or heavy load. Resistant to tears and punctures.

13800570 FFG248 56 gal., 22½" x 20" x 47", Rust, 2.0 MIL 100/cs.

Blue Label Ultimate Can Liners - Flat Packs

Super strong resin blend. Linear low density.

13800576 GR33BL 15 gal., 15" x 9" x 31", Gray, 0.6 MIL 500/cs.

13800259 GR37XH 20-30 gal., 30" x 36", Gray, 1.2 MIL 150/cs.

Brown Label Low Density Can Liners

Paper refuse only.

13800400 BR24BR 10 gal., 15" x 9" x 23", Brown, 0.35 MIL 1000/cs.

13800410 BR335BR 15 gal., 15" x 9" x 31", Brown, 0.35 MIL 500/cs.

13800411 BR33BR 15 gal., 15" x 9" x 31", Brown, 0.35 MIL 1000/cs.

13800415 CL33BR 15 gal., 15" x 9" x 31", Clear, 0.35 MIL 1000/cs.

Green Label Low Density Can Liners - Flat Packs

For all types of refuse. Heavy grade.

13800422 BR37GR 20-30 gal., 30" x 36", Brown, 0.59 MIL 250/cs.

13800455 BR40GR 33 gal., 33" x 39", Brown, 0.59 MIL 250/cs.

13800490 BR64GR 55 gal., 36" x 58", Brown, 0.59 MIL 200/cs.

13800498 BR60GR 60 gal., 38" x 58", Brown, 0.59 MIL 200/cs.

Low Density Can Liners - Flat Packs

Linear low density recycled municipal bags.

13800274 B3339XH 33 gal., 33" x 39", Black, 1.5 MIL, X-Hvy 100/cs.

13800433 BCH40 33 gal., 33" x 39", Black, 1.5 MIL 100/cs.

13800270 B3339XXH 33 gal., 33" x 39", Black, 2 MIL, XX-Hvy 100/cs.

13800439 BCX40 33 gal., 33" x 39", Black, 2 MIL 100/cs.

13800113 BC48 40-45 gal., 40" x 46", Black, 1.3 MIL 100/cs.

13800071 B4046XH 40-45 gal., 40" x 46", Black, 1.5 MIL, X-Hvy 100/cs.

13800446 BCH48 40-45 gal., 40" x 46", Black, 1.5 MIL 100/cs.

B. DURALINER® LINEAR LOW DENSITY LINERS FORTUNE PLASTICS

13800272 B4046XXH 40-45 gal., 40" x 46", Black, 2 MIL, XX-Hvy 100/cs.

13800484 BCX48 40-45 gal., 40" x 46", Black, 2 MIL 100/cs.

13800280 B4347XH 56 gal., 43" x 47", Black, 1.5 MIL, X-Hvy 100/cs.

13800210 BCH47 56 gal., 43" x 47", Black, 1.5 MIL 100/cs.

13800271 BCX47 56 gal., 43" x 47", Black, 2 MIL 100/cs.

13800115 BC60 60 gal., 38" x 58", Black, 1.3 MIL 100/cs.

13800114 BCH60 60 gal., 38" x 58", Black, 1.5 MIL 100/cs.

13800273 B3858XXH 60 gal., 38" x 58", Black, 2 MIL, XX-Hvy 100/cs.

13800638 BCX60 60 gal., 38" x 58", Black, 2 MIL 100/cs.

13800638 BCX60 60 gal., 38" x 58", Black, 2 MIL 100/cs.

13800638 BCX60 60 gal., 38" x 58", Black, 2 MIL 100/cs.

13800638 BCX60 60 gal., 38" x 58", Black, 2 MIL 100/cs.

Red Label Low Density Can Liners - Flat Packs

Paper and plastic refuse only. Medium grade.

13800423 BR37RD 20-30 gal., 30" x 36", Brown, 0.49 MIL 250/cs.

13800453 BR40RD 33 gal., 33" x 39", Brown, 0.49 MIL 250/cs.

Silver Label Low Density Can Liners - Flat Packs

Extra strong for heavy-duty jobs.

13803855 HOB385802 60 gal., 38" x 58", Clear 100/cs.

White Ironman Low Density Can Liners - Flat Packs

Suitable for paper waste and all types of refuse. Can handle wet and/or heavy load. Resistant to tears and punctures. White.

13800449 IM33WH 15 gal., 24" x 32", 0.70 MIL 500/cs.

13800540 IM37WH 20-30 gal., 30" x 37", 0.70 MIL 200/cs.

13800542 IM40WH 33 gal., 33" x 40", 0.70 MIL 150/cs.

13800548 IM48WH 40-45 gal., 40" x 46", 0.75 MIL 100/cs.

13800544 IM248WH 56 gal., 43" x 47", 0.75 MIL 100/cs.

13800546 IM60WH 60 gal., 38" x 60", 0.75 MIL 100/cs.

Yellow Label Low Density Can Liners - Flat Packs

Heaviest of normal refuse.

13800867 BR37YL 20-30 gal., 30" x 36", Brown, .8 MIL 250/cs.

13800386 BR40YL 33 gal., 33" x 39", Brown, .08 GA 250/cs.

13802748 BR48YL 40-45 gal., 40" x 46", Brown, .85 MIL 250/cs.

13800659 CL64YL 55 gal., 36" x 58", Clear, .0015 MIL 200/cs.

C. STEEL-TUFF LOW DENSITY CAN LINERS FORTUNE PLASTICS

Premium resin blend for added strength. Individually folded flat bags. Ties included. Silver. Flat packs.

13803770 FT23770 20-30 gal., 30" x 36", 1.5 MIL 100/cs.

13804070 FT24070 33 gal., 33" x 40", 1.5 MIL 100/cs.

13804870 FT24870 40-45 gal., 39" x 46", 1.7 MIL 50/cs.

13806070 FT26070 55 gal., 39" x 56", 1.7 MIL 50/cs.

13800555 FT24770 56 gal., 43" x 48", 1.7 MIL 50/cs.

Can Liners



CAN LINERS & CONTAINERS

A. HIGH DENSITY CAN LINERS HERITAGE BAG

High molecular/high density liners are strong and durable, but use less raw material. Made from 100% high grade resins.

Coreless Roll

38990249	Z4824RNQR01	8-10 gal., 24" x 24", Natural, 6 MIC	1000/cs.
38990809	Z4824LNR01	8-10 gal., 24" x 24", Red, 8 MIC	1000/cs.
38992644	Z4833RNQR01	12-16 gal., 24" x 33", Natural, 6 MIC	1000/cs.
38993955	Z4833LNQR01	12-16 gal., 24" x 33", Natural, 8 MIC	1000/cs.
38990251	Z6037HNQR01	20-30 gal., 30" x 37", Natural, 13 MIC	500/cs.
38990211	Z6640HNQR02	33 gal., 33" x 40", Natural, 13 MIC	500/cs.
38993965	Z6640XNQR02	33 gal., 33" x 40", Natural, 16 MIC	250/cs.
38990844	Z8048MNQR03	40-45 gal., 40" x 48", Natural, 12 MIC	250/cs.
38993960	Z8048HNQR02	40-45 gal., 40" x 48", Natural, 14 MIC	250/cs.
38990204	Z8048VNQR01	40-45 gal., 40" x 48", Natural, 16 MIC	250/cs.
38991936	Z8048UNR02	40-45 gal., 40" x 48", Natural, 24 MIC	200/cs.
38991098	Z7660VNQR01	60 gal., 38" x 60", Natural, 16 MIC	200/cs.
Flat Pack			
38996040	Z6037HN	20-30 gal., 30" x 37", Natural, 13 MIC	500/cs.
38990237	Z6640MNQX03	33 gal., 33" x 40", Natural, 11 MIC	500/cs.
38993974	Z6640HNQK13	33 gal., 33" x 40", Natural, 13 MIC	125/cs.
38993309	Z8048MNQX02	40-45 gal., 40" x 48", Natural, 10 MIC	250/cs.
38993976	Z8048VNQK16	40-45 gal., 40" x 48", Natural, 16 MIC	100/cs.
38990239	Z8648HNQ	56 gal., 43" x 48", Natural, 14 MIC	200/cs.
38993977	Z8648VNQR03	56 gal., 43" x 48", Natural, 16 MIC	90/cs.
38990244	Z8648VNQ	56 gal., 43" x 48", Natural, 16 MIC	200/cs.
38990246	Z7660HNQ	60 gal., 38" x 60", Natural, 14 MIC	200/cs.
38990212	Z7660VNQ	60 gal., 38" x 60", Natural, 16 MIC	200/cs.

B. LOW DENSITY CAN LINERS HERITAGE BAG

Stock linear low density can liners manufactured from the highest quality raw materials to meet rigid performance specifications. Flat packs.

38990368	H6036MCQ	20-30 gal., 16" x 14" x 36", Clear, Mediumweight	100/cs.
38990273	H6036HCQ	20-30 gal., 16" x 14" x 36", Clear, Heavyweight	250/cs.
38991878	H6639SCQ	33 gal., 23" x 10" x 39", Clear	150/cs.
38995664	H6639HCQ	33 gal., 23" x 10" x 39", Clear	250/cs.
38990347	H7658SCQ	60 gal., 38" x 58", Clear, 1.10 MIL	100/cs.
38995651	H7658HCQ	60 gal., 38" x 58", Clear, 0.70 MIL	200/cs.
38990808	H7658ECQ	60 gal., 38" x 58", Clear, 6 MIC	100/cs.
38994040	H7658TW	60 gal., 38" x 58", White	100/cs.

C. WORKHORSE™ HIGH DENSITY CAN LINERS ROLLPACK

This bag is a good choice when you need extreme load bearing capability, as well as reliable odor containment. Easily handles heavy and wet waste. High-quality HMW-HDPE resins for superior strength and load capacity. Seamless tubular construction. Leak-proof star seal. Convenient coreless rolls. Natural.

61601624	RH624N	7-10 gal., 24" x 24", 6 MIC	1000/cs.
61600037	RH633N	12-16 gal., 24" x 33", 6 MIC	1000/cs.
61600833	RH833N	12-16 gal., 24" x 33", 8 MIC	1000/cs.
61601037	RH1037N	20-30 gal., 30" x 37", 10 MIC	500/cs.
61600640	RH1640N	33 gal., 33" x 40", 16 MIC	250/cs.
61601248	RH1248N	40-45 gal., 40" x 48", 12 MIC	250/cs.
61600012	RH1648N	40-45 gal., 40" x 48", 16 MIC	250/cs.
61600010	RH1649N	56 gal., 43" x 48", 16 MIC	200/cs.
61600013	RH17860N	60 gal., 38" x 60", 17 MIC	200/cs.

D. BULLDOG™ BLENDED RECYCLED LOW DENSITY CAN LINERS ROLLPACK

When you need an affordable, no-nonsense Green option, choose eco-friendly Rollpak Bulldog™ liners, which meet or exceed EPA standards for post-consumer waste. Made with up to 70% recycled material, thereby helping to save energy and preserve non-renewable natural resources. Coreless rolls.

61609265	PR39125	33 gal., 33" x 40", Black, 1.25 MIL	100/cs.
61609021	PR58150	60 gal., 38" x 58", Black, 1.50 MIL	10/10/cs.
61609105	PR60200	60 gal., 38" x 58", Black, 2.00 MIL	50/cs.

E. LOADSTAR™ LINEAR LOW DENSITY CAN LINER ROLLPACK

A strong, all purpose can liner that delivers total confidence. Ideal for industrial, commercial and institutional use. Can be used for everything from paper and general refuse to heavy or sharp waste. Seamless tubular construction. Leak-proof star seal. White.

61602323	RP232W	12-16 gal., 24" x 33", .47 MIL	500/cs.
----------	--------	--------------------------------	---------

F. MAGNUM® HIGHER ALPHA OLEFIN CAN LINER ROLLPACK

Gauge for gauge, Magnum® liners are the toughest in the industry. These super hexene liners deliver total confidence. Ideal for industrial, commercial and institutional use. Can be used for everything from paper and general refuse to heavy or sharp waste. Seamless tubular construction. Leak-proof star seal. Coreless rolls. Steel blue.

61600122	MX2248SB	40-45 gal., 40" x 48", 0.87 MIL	150/cs.
----------	----------	---------------------------------	---------

Can Liners/Lawn & Leaf Bags/Wastebaskets



HEALTHCARE LINERS

A. BIOHAZARD CAN LINER FORTUNE PLASTICS

Manufactured from high grade polyethylene with the biohazard icon. Meets all current D.O.T. specifications.

13800535 CB48FLA 45 gal., 40" x 46", Red, 1.2 MIL 100/cs.



ECO-FRIENDLY LINERS

B. COMP-LETE™ COMPOSTABLE BAGS FORTUNE PLASTICS

Offer superior strength and compostability. BPI's "Compostable Logo" is awarded to products that meet ASTM D6400, assuring end users and composters that the bags will biodegrade swiftly and safely during municipal, commercial, or household composting. Will not leave plastic residues in the finished compost. Made from Mater Bi™ material. Ideal for collecting food scraps and yard trimmings for composting. Replacing non-degradable trash bags with compostable ones helps composters reduce processing, separation, and disposal costs while keeping consumers collection bins clean, which encourages participation.

13800092 BIO3980R 33 gal., 30" x 39", Natural, 0.80 MIL 250/cs.

13800088 BIO4685R 40-45 gal., 40" x 46", Natural, 0.85 MIL 200/cs.



C. BIOTUF™ COMPOSTABLE BAGS HERITAGE BAG

Tough on trash, easy on the environment. Superior strength designed for pre- and post-consumer food waste diversion programs. Excellent puncture and tear resistance. Proven lifting strength and load capacity. Odor control, dissipates moisture. 100% biodegradable and compostable. Photodegrades if left by roadside. 100% ASTM D6400 certified degradable, 100% compostable. Light green.

38996649 Y6039SER01 30 gal., 30" x 39", 1.2 MIL 125/cs.

38996650 Y6848YER01 32 gal., 34" x 48", 1 MIL 100/cs.

38996651 Y8448YER01 48 gal., 42" x 48", 1 MIL 100/cs.

38996652 Y9460YER01 64 gal., 47" x 60", 1 MIL 100/cs.



D. NATURE FRIENDLY® TRASH BAGS NATURE FRIENDLY PRODUCTS

Nature Friendly Products' trash bags and liners are designed to meet the requirements of the food service industry and protect the environment. They are fully compostable and biodegradable in approximately 50-100 days in properly maintained compost facilities. These products are made from a polyester-based proprietary resin that is fully certified biodegradable and compostable, meeting the ASTM D6400 Standards for Compostability.

They are superior in quality, strength and performance, BPI approved, and non-toxic.

C6937003 G105 55 gal., Large, 0.9 MIL 100/cs.

C6937007 G106 69 gal., Large, 0.9 MIL 80/cs.



LAWN & LEAF BAGS

E. LAWN & LEAF BAG DURO BAG

Heavy-duty, self-standing bag for leaves, grass clippings and yard trash. Two-ply kraft paper, outer ply is wet-strength for stability in bad weather. Biodegradable. Compatible for composting programs.

13203452 83452 30 gal., 16" x 12" x 35", Plain 50/bl.



WASTEBASKETS

F. FIRE-RESISTANT WASTEBASKETS CCP

Injection molded glass-filled material is tough and practical. Seamless construction for easy cleaning. UL Classified.

276029271 2927BN 27⁵/₈ qt., Brown 1/ea.

27602927 2927BN 27⁵/₈ qt., Brown 6/cs.



Wastebaskets



A. RECTANGULAR WASTEBASKETS

CCP

Injection molded plastic, seamless construction for easy cleaning. Molded in colors will not crack, peel, chip or scratch.



276010931	<i>1358BK</i>	13 ⁵ / ₈ qt., Black	1/ea.
276010965	<i>1358DB</i>	13 ⁵ / ₈ qt., Dark Brown	1/ea.
276012431	<i>2818BE</i>	28 ¹ / ₈ qt., Beige	1/ea.
276012461	<i>2818BK</i>	28 ¹ / ₈ qt., Black	1/ea.
276012491	<i>2818BN</i>	28 ¹ / ₈ qt., Brown	1/ea.
27601252	<i>2818GY</i>	28 ¹ / ₈ qt., Gray	12/cs.
276013211	<i>4114BE</i>	41 ¹ / ₄ qt., Beige	1/ea.
276013201	<i>4114GY</i>	41 ¹ / ₄ qt., Gray	1/ea.

B. DESKSIDE WASTEBASKETS

RUBBERMAID

Space-efficient and economical. Fits under standard desk height even when swing top is fully extended. All-plastic construction won't chip, rust or dent. Rolled rims add strength and are easy-to-clean.



17700823	<i>2956BEIG</i>	28 ¹ / ₈ qt., Beige, Medium	12/cs.
177078511	<i>2956BLA</i>	28 ¹ / ₈ qt., Black, Medium	1/ea.
17707851	<i>2956BLA</i>	28 ¹ / ₈ qt., Black, Medium	12/cs.
177008481	<i>2956LGRAY</i>	28 ¹ / ₈ qt., Light Gray, Medium	1/ea.
17700848	<i>2956LGRAY</i>	28 ¹ / ₈ qt., Light Gray, Medium	12/cs.

C. FIRE-RESISTANT WASTEBASKETS

RUBBERMAID

Rounded corners add strength and are easy-to-clean. Long-lasting fiberglass resists chips and does not rust. Textured finish helps minimize appearance of surface scratches. California State Fire Marshal (CSFM) approved for fire safety. Tested and classified by Underwriters Laboratories as able to contain burning paper without the wastebasket melting or contributing fuel to the container's contents.



17700365	<i>2540BEIG</i>	7 qt., Beige	6/cs.
177025451	<i>2541BEIG</i>	14 qt., Beige	1/ea.
17702545	<i>2541BEIG</i>	14 qt., Beige	6/cs.
177008451	<i>2541BLA</i>	14 qt., Black	1/ea.
17700845	<i>2541BLA</i>	14 qt., Black	6/cs.
17702546	<i>2541GRAY</i>	14 qt., Light Gray	6/cs.
177025431	<i>2543BEIG</i>	28 qt., Beige	1/ea.
17702543	<i>2543BEIG</i>	28 qt., Beige	6/cs.
177025531	<i>2543BLA</i>	28 qt., Black	1/ea.
17702553	<i>2543BLA</i>	28 qt., Black	6/cs.
177025541	<i>2543GRAY</i>	28 qt., Light Gray	1/ea.
17702554	<i>2543GRAY</i>	28 qt., Light Gray	6/cs.
177025441	<i>2544BEIG</i>	40 qt., Beige	1/ea.
17702544	<i>2544BEIG</i>	40 qt., Beige	4/cs.

D. SOFT WASTEBASKETS

RUBBERMAID

Soft wastebasket provides space-efficiency and economical value. Rolled rims add durability and are easy-to-clean. All-plastic construction won't chip, rust or dent.



177078361	<i>2955BEIG</i>	13 ⁵ / ₈ qt., Small, Beige	1/ea.
17707836	<i>2955BEIG</i>	13 ⁵ / ₈ qt., Small, Beige	12/cs.
177078381	<i>2955BLA</i>	13 ⁵ / ₈ qt., Small, Black	1/ea.
17707838	<i>2955BLA</i>	13 ⁵ / ₈ qt., Small, Black	12/cs.
177078541	<i>2957BEIG</i>	41 ¹ / ₄ qt., Large, Beige	1/ea.
17707854	<i>2957BEIG</i>	41 ¹ / ₄ qt., Large, Beige	12/cs.
177029501	<i>2957BLA</i>	41 ¹ / ₄ qt., Large, Black	1/ea.
17702950	<i>2957BLA</i>	41 ¹ / ₄ qt., Large, Black	12/cs.
177078581	<i>2957LGRAY</i>	41 ¹ / ₄ qt., Large, Light Gray	1/ea.
17707858	<i>2957LGRAY</i>	41 ¹ / ₄ qt., Large, Light Gray	12/cs.

Trash Containers



STEP-ON TRASH CONTAINERS

A. PEDAL ROLLTOP CONTAINER RUBBERMAID

Slim oval shape fits easily in tight spaces. Rolltop lid minimizes airborne odors. Large foot pedal accessible from front and sides. Slim shape fits under counters and out of the way. Factory Mutual (FM) and California State Fire Marshal (CSFM) approved for fire safety. Seamless construction resists leaking. Stainless steel lifting rods provide long-lasting, reliable performance.

17706177 6177BEIG 14½ gal., 22¼" x 14½" x 27¾", Beige 1/ea.



B. MOBILE STEP-ON CONTAINERS RUBBERMAID

Ideal for hands-free, sanitary refuse disposal. Tight-fitting, overlapping lid to help contain odors. Tough, puncture-resistant, all-plastic construction. Quiet, heavy-duty pedal for hands-free sanitary use. Assists in complying with OSHA regulation (Occupational Exposure to Bloodborne Pathogens). Factory Mutual (FM) and California State Fire Marshal (CSFM) approved for fire safety. Optional rigid liners provide a leak-proof base to help contain liquids.

17706146 6146BEIG 23 gal., Beige 1/ea.

17706148 6146RED 23 gal., Red 1/ea.

17706151 6146WHT 23 gal., White 1/ea.



C. STEP-ON CONTAINERS RUBBERMAID

Containers

Hands-free sanitary waste management. Assists in complying with OSHA regulation; 29 CFR 1910.1030 (Occupational Exposure to Bloodborne Pathogens). Factory Mutual (FM) and California State Fire Marshal (CSFM) approved for fire safety. Tight-fitting, overlapping lid to help contain odors. Quiet, heavy-duty pedal for hands-free sanitary use. Tough, puncture-resistant, all-plastic construction.

17706144 6143BEIG 8 gal., Beige 1/ea.

17700054 6143RED 8 gal., Red 1/ea.

17706143 6143WHT 8 gal., White 1/ea.

17704461 6144BEIG 12 gal., Beige 1/ea.

17706147 6144RED 12 gal., Red 1/ea.

17706145 6145BEIG 18 gal., Beige 1/ea.

17700145 6145RED 18 gal., Red 1/ea.

17700053 6145WHT 18 gal., White 1/ea.

Rigid Liners

Prolongs the life of your containers. Custom designed to fit Rubbermaid and other manufacturers' containers. One piece plastic construction for long product life.

17706245 6245 15 gal., Fits 6145 4/cs.

17706246 6246 19 gal., Fits 6146 4/cs.



D. STEP-ON CONTAINER W/RIGID LINER RUBBERMAID

Ideal for hands-free, sanitary refuse disposal. Tight-fitting, overlapping lid to help contain odors. Tough, puncture-resistant, all-plastic construction. Quiet, heavy-duty pedal for hands-free sanitary use. Assists in complying with OSHA regulation (Occupational Exposure to Bloodborne Pathogens). Factory Mutual (FM) and California State Fire Marshal (CSFM) approved for fire safety. Rigid liners provide a leak-proof base to help contain liquids.

17700142 6142 4½ gal., White 1/ea.

TRASH CONTAINERS/LIDS

E. SWINGLINE™ SQUARE RECEPTACLE BASES/LIDS CCP

Bases

Rolled rim provides strength and convenient area to lift or pull. Reinforced base withstands rough commercial use. Nests for easy storage.

27600025 25BE 25 gal., Beige 4/cs.

276001731 32GY 32 gal., Gray 1/ea.

Swing Top Lid

Swings open making refuse disposal easy. Peaked design is counter weighted and automatically closes to hide trash. Fits 25 and 32 gal. receptacle bases.

276011201 1600GY 7⅞" x 16½" Sq., Gray 1/ea.

Tip Top Lid

Gravity, hands-free opening encourages use and automatically closes to hide trash.

276032291 T1700GY Fits #25 & #32 Base, Gray 1/ea.





Trash Containers

A. WALL HUGGER™ CONTAINERS/LIDS

CCP

Rectangle Containers

The Wall Hugger™ has a sleek and attractive design that holds 23 gallons of waste, but protrudes less than one foot from the wall. The smooth, seamless design provides prolonged life and promotes easy cleaning. A molded-in "Bag Cinch" eliminates the need to tie knots in the polyliner to keep it secure around the receptacle's rim. Molded-in hand grips in the receptacle base provide a secure area to grasp when lifting and dumping.



276008441	<i>8322BE</i>	23 gal., Beige	1/ea.
27600839	<i>8322BN</i>	23 gal., Brown	4/cs.
276083201	<i>8322GY</i>	23 gal., Gray	1/ea.
27608320	<i>8322GY</i>	23 gal., Gray	4/cs.

Built of durable engineered plastic. Sleek, attractive design protrudes less than one foot from the wall. Smooth, seamless construction for easy cleaning. Compatible with the (7318) push door lid or (7320) Tip-Top lid.

276015111	<i>8323BN</i>	23 gal., Brown	1/ea.
------------------	---------------	----------------	-------

Half Round Containers

Extra large top opening provides easy access. Rounded front and sides allow use where other containers would interfere with traffic. Rolled top edge adds strength and provides convenient area to lift or pull.

276000621	<i>8321BE</i>	21 gal., 28 ³ / ₈ " x 21 ³ / ₄ " x 12", Beige	1/ea.
276083211	<i>8321GY</i>	21 gal., 28 ³ / ₈ " x 21 ³ / ₄ " x 12", Gray	1/ea.

Drop Shot Lids

Helps to conceal waste while providing an inviting, enlarged opening for waste disposal. The 8¹/₄" x 16³/₄" opening is the largest available in a Wall Hugger™ style receptacle.

276000061	<i>7325BN</i>	Fits 23 gal. Wall Hugger, Brown	1/ea.
276073251	<i>7325GY</i>	Fits 23 gal. Wall Hugger, Gray	1/ea.

B. HUSKEE™ ROUND CONTAINERS/LIDS

CCP

Containers

Made of engineered resins with a seamless construction to provide maximum strength and easy cleaning. Huskee™ can be used for a range of commercial applications such as refuse collection or food storage. Containers and lids sold separately.



276010091	<i>1001WH</i>	10 gal., White	1/ea.
276011531	<i>2000GY</i>	20 gal., Gray	1/ea.
27601153	<i>2000GY</i>	20 gal., Gray	6/cs.
276011551	<i>2000WH</i>	20 gal., White	1/ea.
27601155	<i>2000WH</i>	20 gal., White	6/cs.
276012761	<i>3200GY</i>	32 gal., Gray	1/ea.
27601276	<i>3200GY</i>	32 gal., Gray	6/cs.
276032021	<i>3200WH</i>	32 gal., White	1/ea.
276032001	<i>3200YW</i>	32 gal., Yellow	1/ea.
276044451	<i>4444GY</i>	44 gal., Gray	1/ea.
27604445	<i>4444GY</i>	44 gal., Gray	4/cs.
276000131	<i>4444YW</i>	44 gal., Yellow	1/ea.
276085071	<i>5500GY</i>	55 gal., Gray	1/ea.

Dome Top Lid

The economic answer wherever large refuse collection in public places is required. Conveniently sized to fit Huskee™ receptacle. Wide rim and tight fitting door with rain deflector keeps debris and odors in and rain and pests out.

27604456	<i>4456GY</i>	Fits 44 gal., Gray	3/cs.
-----------------	---------------	--------------------	-------

Round Container Lids

Lids for round Huskee™ containers.

276011571	<i>2001GY</i>	Fits 20 gal., Gray	1/ea.
276020011	<i>2001WH</i>	Fits 20 gal., White	1/ea.
276012791	<i>3201GY</i>	Fits 32 gal., Gray	1/ea.
27601279	<i>3201GY</i>	Fits 32 gal., Gray	6/cs.
276032031	<i>3201WH</i>	Fits 32 gal., White	1/ea.
276013361	<i>4445GY</i>	Fits 44 gal., Gray	1/ea.
276099041	<i>4445WH</i>	Fits 44 gal., White	1/ea.
276085061	<i>5501GY</i>	Fits 55 gal., Gray	1/ea.
27608506	<i>5501GY</i>	Fits 55 gal., Gray	3/cs.

Trash Containers



A. KING KAN® TRASH RECEPTACLES CCP

Molded of structural plastic for increased durability. Can be used for indoor and outdoor applications. Lid features two heavy-duty plated steel hinges that eliminates awkward lifting, removing and repositioning of the lid. The lid sits tightly on the base.

27601371	<i>5735BN</i>	35 gal., 39 ¹ / ₂ " x 20" x 20", Brown	1/ea.
27601567	<i>5750BE</i>	50 gal., 40 ¹ / ₂ " x 23 ³ / ₄ " x 23 ³ / ₄ ", Beige	1/ea.



B. MARSHAL® TRASH CONTAINERS RUBBERMAID

Practical good looks combined with fire safety. Factory Mutual (FM) and California State Fire Marshal (CSFM) approved for fire safety. Includes retainer hardware for securing and concealing polyliner bags. Textured finish helps minimize appearance of surface scratches.

17706088	<i>816088BEIG</i>	15 gal., Beige	1/ea.
17706089	<i>816088BLA</i>	15 gal., Black	1/ea.
17706090	<i>816088BRN</i>	15 gal., Brown	1/ea.
17707088	<i>817088BEIG</i>	25 gal., Beige	1/ea.
17707089	<i>817088BLA</i>	25 gal., Black	1/ea.
17707090	<i>817088BRN</i>	25 gal., Brown	1/ea.
17707091	<i>817088OWHT</i>	25 gal., Off White	1/ea.



Mirror Stainless Steel

Excellent for indoor applications. Fire-safe construction, ADA compliant. Stainless steel containers constructed of #304 material. Powder coat containers constructed of heavy gauge galvanized steel. Self-closing, reinforced, mirror-polished stainless steel door. Stainless steel, corrosion-resistant reinforcing bottom rim protects floors. Recessed hand grips offer easy lifting for refuse removal. Equipped with rigid liners.

17709624	<i>9624MSSTL</i>	15 gal., 15 ¹ / ₂ " dia. x 36 ¹ / ₂ "H	1/ea.
-----------------	------------------	--	-------

C. ATRIUM™ WASTE CONTAINERS RUBBERMAID

Mirror Stainless Steel

Steel container with open top. Decorative, indoor waste management. Stainless steel containers constructed of #304 heavy gauge material. Protective trim on all openings protects containers and helps reduce potential for injury. Stainless steel, corrosion-resistant reinforcing bottom rim protects floors. Excellent for indoor applications. Fire-safe construction, ADA compliant.

17700923	<i>9066MSSTL</i>	15 gal., 14 ⁵ / ₈ " dia. x 28 ¹ / ₂ "H, Mirror	1/ea.
-----------------	------------------	--	-------

Satin Aluminum

Ideal for use in airports, office buildings and malls. Heavy gauge aluminum is corrosion resistant. Fire safe construction. Hammered silver finish is highly scratch resistant. High quality polish on satin finish eliminated spinning lines and blemishes. Corrosion resistant, fire safe, and ADA compliant. Plastic liners prevent leakage (#3546 sold separately).

17709079	<i>9079SALUM</i>	35 gal., 18" dia. x 32 ¹ / ₂ "H	1/ea.
-----------------	------------------	---	-------



D. UNTOUCHABLE® CONTAINERS/LIDS RUBBERMAID

Durable and crack resistant, even under tough indoor/outdoor conditions. Perfect for hotel lobbies, restrooms, shopping malls, restaurants and snack areas.

Half Round Containers

177035201	<i>3520BEIG</i>	21 gal., 21"L x 11"W x 28"H, Beige	1/ea.
17703520	<i>3520BEIG</i>	21 gal., 21"L x 11"W x 28"H, Beige	4/cs.
17707976	<i>3520GRAY</i>	21 gal., 21"L x 11"W x 28"H, Gray	4/cs.

Round Containers

177029471	<i>2947GRAY</i>	44 ³ / ₈ qt., 15 ³ / ₄ " dia. x 18 ³ / ₄ "H, Light Gray	1/ea.
17700828	<i>3546BEIG</i>	22 gal., 15 ³ / ₄ " dia. x 30 ¹ / ₈ "H, Beige	4/cs.
177079941	<i>3546GRAY</i>	22 gal., 15 ³ / ₄ " dia. x 30 ¹ / ₈ "H, Gray	1/ea.
17707994	<i>3546GRAY</i>	22 gal., 15 ³ / ₄ " dia. x 30 ¹ / ₈ "H, Gray	4/cs.

Square Containers

17708002	<i>3568GRAY</i>	19 gal., 14 ¹ / ₂ " sq. x 24"H, Gray	4/cs.
177080081	<i>356988BEIG</i>	23 gal., 14 ¹ / ₂ " sq. x 28"H, Beige	1/ea.
17708006	<i>3569BEIG</i>	23 gal., 14 ¹ / ₂ " sq. x 28"H, Beige	4/cs.
17706988	<i>356988GRAY</i>	23 gal., 14 ¹ / ₂ " sq. x 28"H, Gray	4/cs.
17708054	<i>3958BEIG</i>	35 gal., 19 ¹ / ₂ " sq. x 27 ⁵ / ₈ "H, Beige	4/cs.
177080541	<i>3958BEIG</i>	35 gal., 19 ¹ / ₂ " sq. x 27 ⁵ / ₈ "H, Beige	1/ea.
177039581	<i>3958GRAY</i>	35 gal., 19 ¹ / ₂ " sq. x 27 ⁵ / ₈ "H, Gray	1/ea.
17703958	<i>3958GRAY</i>	35 gal., 19 ¹ / ₂ " sq. x 27 ⁵ / ₈ "H, Gray	4/cs.
17703959	<i>3959BEIG</i>	50 gal., 19 ³ / ₄ " sq. x 34"H, Beige	4/cs.
177039591	<i>3959BEIG</i>	50 gal., 19 ³ / ₄ " sq. x 34"H, Beige	1/ea.
17703960	<i>3959GRAY</i>	50 gal., 19 ³ / ₄ " sq. x 34"H, Gray	4/cs.





Trash Containers

CAN LINERS & CONTAINERS



A. UNTOUCHABLE® CONTAINERS/LIDS (CONT.) RUBBERMAID

Drop & Swing Lids

For hygienic, hands-free refuse disposal. Drop and swing lid designs provide easy access for refuse disposal and then quickly return to hide refuse from public view. Controls waste, odors and smoking debris. Fits 19/23 gal. square bases.

- | | | | |
|------------------|------------------|---|-------|
| 177002101 | 2689LGRAY | 14 ⁷ / ₈ " sq. x 4 ¹ / ₂ "H, Gray | 1/ea. |
| 17700210 | 2689LGRAY | 14 ⁷ / ₈ " sq. x 4 ¹ / ₂ "H, Gray | 4/cs. |

Half Round Lid w/Swing Door Lids

Hygienic tops for attractive, hands-free waste disposal. Swing lid design provides easy access and quickly returns to hide refuse from public view.

- | | | | |
|------------------|----------------|--|-------|
| 177036211 | 3620BLA | 21 ⁵ / ₁₆ " x 12 ⁵ / ₁₆ " x 9 ¹ / ₂ ", Black | 1/ea. |
| 17703621 | 3620BLA | 21 ⁵ / ₁₆ " x 12 ⁵ / ₁₆ " x 9 ¹ / ₂ ", Black | 4/cs. |

Round Top

Drop and swing lid designs provide easy access for refuse disposal and then quickly return to hide refuse from public view. Controls waste, odors and smoking debris.

- | | | | |
|------------------|------------------|----------------------------------|-------|
| 177077861 | 2672LGRAY | Fits 2947/3546 Bases, Light Gray | 1/ea. |
|------------------|------------------|----------------------------------|-------|

Square Tops

Square top fits 3958 and 3959 bases. Provides easy access for refuse disposal and then quickly return to hide refuse from public view. Controls waste, odors and smoking debris.

- | | | | |
|------------------|-----------------|------------------------|-------|
| 177077721 | 2664BEIG | Fits 35/50 gal., Beige | 1/ea. |
| 17707772 | 2664BEIG | Fits 35/50 gal., Beige | 4/cs. |
| 177002661 | 2664GRAY | Fits 35/50 gal., Gray | 1/ea. |
| 17700266 | 2664GRAY | Fits 35/50 gal., Gray | 4/cs. |

Swing Tops

Hygienic top for attractive, hands-free waste disposal. Swing lid design provides easy access and quickly returns to hide refuse from public view. Controls litter, odors and insects. For 3569-07, 3569-88 containers.

- | | | | |
|------------------|-------------------|------------------------|-------|
| 177026931 | 268988BEIG | Fits 19/23 gal., Beige | 1/ea. |
| 17702693 | 268988BEIG | Fits 19/23 gal., Beige | 4/cs. |
| 177026941 | 268988BLA | Fits 19/23 gal., Black | 1/ea. |

B. SLIM JIM® CONTAINERS/LIDS RUBBERMAID

Containers

Efficient size and shape fits tight spaces. Durable, all-plastic construction is easy-to-clean and provides long life. All Slim Jim® tops fit on all Slim Jim® containers.

- | | | | |
|------------------|------------------|--------------------|-------|
| 17700858 | 3540BEIG | 23 gal., Beige | 4/cs. |
| 177079851 | 3540BLA | 23 gal., Black | 1/ea. |
| 17707985 | 3540BLA | 23 gal., Black | 4/cs. |
| 177079861 | 3540BRN | 23 gal., Brown | 1/ea. |
| 17707986 | 3540BRN | 23 gal., Brown | 4/cs. |
| 177004321 | 3540DBLUE | 23 gal., Dark Blue | 1/ea. |
| 17700432 | 3540DBLUE | 23 gal., Dark Blue | 4/cs. |
| 177001231 | 3540GRAY | 23 gal., Gray | 1/ea. |
| 17700123 | 3540GRAY | 23 gal., Gray | 4/cs. |

Wall Mount Containers

Attractive design blends with most decors. Wall mounting keeps the container out of pedestrian traffic and allows for floor cleaning. California State Fire Marshal (CSFM) approved for fire safety. Factory Mutual approved for fire safety when wall mounted.

- | | | | |
|-----------------|-----------------|----------------|-------|
| 17707819 | 7822BEIG | 15 gal., Beige | 1/ea. |
|-----------------|-----------------|----------------|-------|

Containers w/Handles

Efficient size and shape fits tight spaces. Durable, all-plastic construction is easy-to-clean and provides long life. All Slim Jim® tops fit on all Slim Jim® containers.

- | | | | |
|------------------|------------------|--|-------|
| 17700859 | 3541BEIG | 15 ⁷ / ₈ gal., Beige | 4/cs. |
| 177008601 | 3541DBLUE | 15 ⁷ / ₈ gal., Dark Blue | 1/ea. |
| 177035411 | 3541GRAY | 15 ⁷ / ₈ gal., Gray | 1/ea. |
| 17703541 | 3541GRAY | 15 ⁷ / ₈ gal., Gray | 4/cs. |
| 17703554 | 3554LGRAY | 23 gal., Light Gray | 4/cs. |

Containers w/Venting Channels

Features innovative patent-pending solutions that increase efficiency and improve worker well-being. Integrated, patent-pending venting channels take the strain out of liner removal. Space-saving profile fits virtually anywhere. Four patent-pending can liner cinches improve productivity. Molded-in handles and base grips make lifting and emptying easier.

- | | | | |
|------------------|-------------------|-----------------------------------|-------|
| 177001111 | 354060GRAY | 23 gal., 22"L x 11"W x 30"H, Gray | 1/ea. |
|------------------|-------------------|-----------------------------------|-------|



Trash Containers



A. SLIM JIM® CONTAINERS/LIDS (CONT.)

RUBBERMAID

Swing Lids

Promote recycling and improve productivity. Swing top provides easy access for trash disposal and then swings back to hide trash from public view. Encourage waste separation and recycling with interchangeable, color-coded tops.

177001101	267360BLA	Fits 15 ⁷ / ₈ & 23 gal., Black	1/ea.
177026711	267360DBLUE	Fits 15 ⁷ / ₈ & 23 gal., Dark Blue	1/ea.
177026741	267360GRAY	Fits 15 ⁷ / ₈ & 23 gal., Gray	1/ea.

B. BRUTE® ROUND CONTAINERS/LIDS

RUBBERMAID

Containers

All plastic construction will not rust, chip or peel; resists dents. Reinforced rims for added strength and durability. Built-in handles for easy, non-slip lifting; easy anti-jam nesting. Double-ribbed base for increased stability and dragging capacity.

177076781	2610GRAY	10 gal., Gray	1/ea.
17707678	2610GRAY	10 gal., Gray	6/cs.
177076801	2610WHT	10 gal., White	1/ea.
17707680	2610WHT	10 gal., White	6/cs.
177026211	2620DBLUE	20 gal., Dark Blue	1/ea.
177077021	2620GRAY	20 gal., Gray	1/ea.
177077041	2620WHT	20 gal., White	1/ea.
17707704	2620WHT	20 gal., White	6/cs.
177026321	2632DBLUE	32 gal., Dark Blue	1/ea.
17702632	2632DBLUE	32 gal., Dark Blue	6/cs.
177026531	2632DGRN	32 gal., Dark Green	1/ea.
177077201	2632GRAY	32 gal., Gray	1/ea.
17707720	2632GRAY	32 gal., Gray	6/cs.
177077251	2632RED	32 gal., Red	1/ea.
17707725	2632RED	32 gal., Red	6/cs.
177077221	2632WHT	32 gal., White	1/ea.
17707722	2632WHT	32 gal., White	6/cs.
17707729	2632YEL	32 gal., Yellow	6/cs.
17702642	2643DBLUE	44 gal., Dark Blue	4/cs.
177077381	2643GRAY	44 gal., Gray	1/ea.
17707738	2643GRAY	44 gal., Gray	4/cs.
177077421	2643RED	44 gal., Red	1/ea.
17707742	2643RED	44 gal., Red	4/cs.
177077401	2643WHT	44 gal., White	1/ea.
17707740	2643WHT	44 gal., White	4/cs.
177026431	2643YEL	44 gal., Yellow	1/ea.
17702643	2643YEL	44 gal., Yellow	4/cs.
177077621	2655GRAY	55 gal., Gray	1/ea.
17707762	2655GRAY	55 gal., Gray	3/cs.

Dome Tops

17703788	263788GRAY	Fits 32 gal., Gray	1/ea.
17704788	264788GRAY	Fits 44 gal., Light Gray	1/ea.
17707753	264788RED	Fits 44 gal., Red	1/ea.
17704790	265788GRAY	Fits 55 gal., Gray	1/ea.
17705788	265788RED	Fits 55 gal., Red	1/ea.

Funnel Top

17707987	3543	Fits 32 gal., Gray	4/cs.
----------	------	--------------------	-------

Round Container Snap-On Flat Lids

Strong, snap-on flat lid for stacking. All-plastic, professional-grade construction.

177076761	2609WHT	Fits 10 gal., White	1/ea.
177077141	2631GRAY	Fits 32 gal., Gray	1/ea.
17707714	2631GRAY	Fits 32 gal., Gray	6/cs.
17700847	2645GRAY	Fits 44 gal., Gray	4/cs.
177077601	2654GRAY	Fits 55 gal., Gray	1/ea.
17707760	2654GRAY	Fits 55 gal., Gray	3/cs.

Self-Draining Flat Lids

177026601	264560BLA	Fits 44 gal., Black	1/ea.
177008611	264560GRAY	Fits 44 gal., Gray	1/ea.



CAN LINERS & CONTAINERS

Trash Containers/Recycling Containers



A. SQUARE BRUTE® CONTAINERS W/O LIDS RUBBERMAID

More capacity for storage or refuse collection. Square shape offers up to 14% more capacity than round containers. Nesting handles allow secure fit for side by side use. Rounded corners and smooth contours are easy-to-clean.

177008261	3526GRAY	28 gal., Gray (USDA Meat & Poultry)	1/ea.
177035421	3536GRAY	40 gal., Gray	1/ea.
17703542	3536GRAY	40 gal., Gray	4/cs.



B. BRUTE® ROLL OUT CONTAINERS RUBBERMAID

Easy mobility for general refuse collection and material handling. Heavy-duty, one-piece handle provides large, strong grip area. Ground-hugging base is designed for stability even in high winds and on uneven surfaces. Molded-in, reinforced lift points help distribute loads evenly. Inset wheel position helps prevent damage to walls and doorways. Molded-in foot tilter helps maneuver heavy loads. One piece body construction provides superior strength and durability.

17709260	9W21GRAY	65 gal., Gray	1/ea.
17709114	9W22GRAY	95 gal., 35 ⁵ / ₈ "L x 27 ¹ / ₈ "W x 45 ⁵ / ₈ "H, Gray	1/ea.
w/Lids			
17709256	9W27BLUE	50 gal., 28 ¹ / ₂ "L x 23 ³ / ₈ "W x 36 ¹ / ₂ "H, Blue	2/cs.
177092551	9W27GRAY	50 gal., 28 ¹ / ₂ "L x 23 ³ / ₈ "W x 36 ¹ / ₂ "H, Gray	1/ea.
17709255	9W27GRAY	50 gal., 28 ¹ / ₂ "L x 23 ³ / ₈ "W x 36 ¹ / ₂ "H, Gray	2/cs.
177092571	9W27YEL	50 gal., 28 ¹ / ₂ "L x 23 ³ / ₈ "W x 36 ¹ / ₂ "H, Yellow	1/ea.
17709257	9W27YEL	50 gal., 28 ¹ / ₂ "L x 23 ³ / ₈ "W x 36 ¹ / ₂ "H, Yellow	2/cs.



C. GLUTTON® TRASH CONTAINERS/LID RUBBERMAID

Containers

Large capacity containers for indoor and outdoor waste handling. Built to withstand extreme weather and handling. Hold down base can be filled with sand or water to provide added stability and security. Perfect for large crowds and high-traffic areas.

17700256	256BBRN	56 gal., Brown	4/cs.
17707256	256BOWHT	56 gal., White	4/cs.

Hooded Top

Trimeld® Glutton® hooded top with doors provides added strength and a rain shield. Fits Glutton® container 256B.

17707644	256VBRN	26 ⁵ / ₈ " x 23" x 13"H, Brown	1/ea.
----------	---------	--	-------



D. PLAZA® CONTAINERS RUBBERMAID

Two spring-loaded swing doors help contain odors and control insects. Side-mounted, hinged door offers full interior access for "no lift" refuse removal. Tie-down feature in the container base provides for a secure installation. Molded-in colors and UV inhibitors resist fading. Textured finish helps minimize appearance of surface scratches. Lock latch feature can be used with or without key.

17703964	3964BEIG	50 gal., Beige	1/ea.
17703963	3964DGRN	50 gal., Dark Green	1/ea.
w/Ashtray			
17703968	3965BEIG	50 gal., Beige	1/ea.
17703965	3965DGRN	50 gal., Dark Green	1/ea.



E. RANGER® CONTAINERS RUBBERMAID

Specifically designed for outdoor use. Built to withstand extreme weather. Ideal for fast food restaurants, municipal parks, playgrounds and stadiums. Tops are permanently attached.

17709418	8430BEIG	35 gal., 19 ¹ / ₂ " sq. x 39 ³ / ₄ "H, Beige	1/ea.
17708430	8430BRN	35 gal., 19 ¹ / ₂ " sq. x 39 ³ / ₄ "H, Brown	1/ea.



RECYCLING CONTAINERS

F. RECTANGULAR WASTEBASKET CCP

Injection molded plastic, seamless construction for easy cleaning. Molded in colors will not crack, peel, chip or scratch.

276012551	28181	28 ¹ / ₈ qt., Blue/Recycle	1/ea.
-----------	-------	--	-------

Recycling Containers



CAN LINERS & CONTAINERS

A. WALL HUGGER™ CONTAINER CCP

The Wall Hugger™ has a sleek and attractive design that holds 23 gallons of waste, but protrudes less than one foot from the wall. The smooth, seamless design provides prolonged life and promotes easy cleaning. A molded-in "Bag Cinch" eliminates the need to tie knots in the polyliner to keep it secure around the receptacle's rim. Molded-in hand grips in the receptacle base provide a secure area to grasp when lifting and dumping.

276083271 83221 23 gal., Blue, Recycle Symbol 1/ea.



B. HUSKEE™ ROUND CONTAINER/LID CCP

Containers

Made of engineered resins with a seamless construction to provide maximum strength and easy cleaning. Huskee™ can be used for a range of commercial applications such as refuse collection or food storage. Containers and lids sold separately.

276032011 32001 32 gal., Blue/Recycle 1/ea.

Lid

Center hole for beverage can disposal. Permanent CANS ONLY message.

276012821 32011WH Fits 32 gal., White 1/ea.



C. DESKSIDE RECYCLING CONTAINERS RUBBERMAID

An easy and effective way to recycle paper. Contains Post-Consumer Recycled Resin (PCR) exceeding EPA guidelines. Designed to be used in systems with existing office containers and accessories.

177029551 29573 13³/₈ qt., Small, Blue 1/ea.

177029561 295673 28¹/₈ qt., Medium, Blue 1/ea.

17700814 295673 28¹/₈ qt., Medium, Blue 12/cs.

177008171 295606 28¹/₈ qt., Medium, Green 1/ea.

177029581 295773 41¹/₄ qt., Large, Blue 1/ea.



D. GLUTTON® RECYCLING CONTAINER/LID RUBBERMAID

Large capacity recycling containers for any outdoor environment. Contains Post-Consumer Recycled Resin (PCR) exceeding EPA guidelines. Station containers serve as a convenient central collection site for multiple work stations. Recommended for indoor and outdoor use. Perfect for large crowds and high-traffic areas. Designed to withstand extreme weather and handling. Accepts two Slim Jim® Containers (3540).

177002641 256B73 56 gal., Blue 1/ea.

Bottle & Can Recycling Top

17700258 256LDBLUE For 256B, Dark Blue 1/ea.



E. GLUTTON® RECYCLING STATION RUBBERMAID

Support your facility's recycling program, help reduce labor costs, and improve worker well-being. High-capacity, all-in-one centralized solution for efficient waste sortation. Provided restrictive-opening tops, symbol label pack, and word label pack in three languages provide visual cues and encourage compliance. Hinged lid allows easy access during emptying. Station includes: (2) Glutton® 56 gal. Containers, (4) Slim Jim® 23 gal. Containers, (1) hinged lid frame, (8) restrictive-opening tops: (4) circles, (2) paper slots, (1) square, (1) triangle; (1) label pack - symbol and word labels in English, French and Spanish.

17700155 256R73 92 gal., Blue 1/ea.



F. RECYCLING BOX RUBBERMAID

Stackable recycling boxes made out of Post-Consumer Recycled Resin (PCR) perfect for commercial recycling use. Stackable for convenient use of multiple containers at one time and nestable for easy storage and shipping. Inboard handles for easy lifting and carrying meeting municipality container requirements. Made from linear low density polyethylene to withstand harsh weather conditions and heavy use to prevent cracking, denting or bowing. Texture and design prevent liquid and debris build-up providing an easy-to-clean product.

177057141 571473 14 gal., Blue 1/ea.



Recycling Containers



A

A. SLIM JIM® RECYCLING CONTAINERS/LIDS RUBBERMAID

Container

For use in areas of high paper generation, such as near copiers, printers, and in mailrooms. Contains Post-Consumer Recycled Resin (PCR) exceeding EPA guidelines. Station containers serve as a convenient central collection site for multiple work stations. Recommended for indoor and outdoor use.

177035481 354075 23 gal., Blue, 20"L x 11"W x 30"H 1/ea.

Containers w/Venting Channels

Integrated, patent-pending venting channels take the strain out of liner removal. Space-saving profile fits virtually anywhere. Four patent-pending can liner cinches improve productivity. Molded-in handles and base grips make lifting and emptying easier.

177035461 354007GRN 23 gal., Green 1/ea.

17703546 354007GRN 23 gal., Green 4/cs.

Bottle & Can Recycling Tops

Promote recycling and improve productivity. Interchangeable, color-coded tops promote waste separation: slotted blue top for paper; green, blue and brown round-hole tops for glass bottles, jars and metal cans; gray handle tops for general refuse. All tops fit on 3540, 3541, 3554 containers.

177092881 269288BLUE Fits Slim Jim®, Blue 1/ea.

177006321 269288BRN Fits Slim Jim®, Brown 1/ea.

177026921 269288GRN Fits Slim Jim®, Green 1/ea.

Paper Recycling Top

Promote recycling and improve productivity. Interchangeable, color-coded tops promote waste separation: slotted blue top for paper; green, blue and brown round-hole tops for glass bottles, jars and metal cans; gray handle tops for general refuse. All tops fit on 3540, 3541, 3554 containers.

177027031 270388BLUE 20½" x 11½" x 2¾", Dark Blue 1/ea.



B

B. HALF ROUND RECYCLING CONTAINER RUBBERMAID

For use in areas of high paper generation, such as near copiers, printers and in mailrooms. Station containers serve as a convenient central collection site for multiple work stations. Recommended for indoor and outdoor use. Large capacity ideal for heavy traffic areas. Designed to withstand extreme weather and handling.

177035211 352006BLUE 21 gal., Blue 1/ea.



C

C. SQUARE RECYCLING CONTAINERS RUBBERMAID

For use in areas of high paper generation. Contains Post-Consumer Recycled Resin (PCR) exceeding EPA guidelines. Station containers serve as a convenient central collection site. Recommended for indoor and outdoor use. Large capacity ideal for large crowds and high-traffic areas. Designed to withstand extreme weather and handling.

177039521 395873 35 gal., 19½" sq. x 27⅞"H, Blue 1/ea.

177059051 395973 50 gal., 19½" sq. x 34¼"H, Blue 1/ea.

D. UNTOUCHABLE® SQUARE RECYCLING CONTAINERS/LIDS RUBBERMAID

For use in high-volume areas. Sleek design for a professional image. Contains Post-Consumer Recycled Resin (PCR) exceeding EPA guidelines. Patent Pending can liner cinch allows for bag retention and eliminates knot tying. Station containers provide convenient central collection sites for multiple work stations or areas. All containers come standard with the universal recycle symbol imprint.

177035671 356973 23 gal., Blue 1/ea.

17703569 356973 23 gal., Blue 4/cs.

Bottle & Can Recycling Top

Hygienic top for attractive, hands-free waste disposal. Easy hygienic access for trash disposal. Recycling lid options for sorting. For 3569 containers.

177026951 2691 6"L x 16"W x 3⅞"H, Blue 1/ea.

Bottle & Can Recycling Top

Fits 3958-06 and 3959-06 containers. For use in areas of high paper generation, such as near copiers, printers and in mailrooms. Station containers serve as a convenient central collection site for multiple work stations. Recommended for indoor and outdoor use. Large capacity ideal for heavy traffic areas. Perfect for large crowds and high-traffic areas. Designed to withstand extreme weather and handling.

177027911 2791 20⅞" sq. x 6¼"H, Dark Blue 1/ea.



D

Recycling Containers/Dollies



A. UNTOUCHABLE® SQUARE RECYCLING CONTAINERS/LIDS (CONT.)

RUBBERMAID

Paper Recycling Top

Fits 3958-06 and 3959-06 containers. For use in areas of high paper generation, such as near copiers, printers and in mailrooms. Station containers serve as a convenient central collection site for multiple work stations. Recommended for indoor and outdoor use. Large capacity ideal for heavy traffic areas. Perfect for large crowds and high-traffic areas. Designed to withstand extreme weather and handling.

177059071 2794 20 1/8" sq. x 6 1/4" H, Dark Blue 1/ea.



B. BRUTE® RECYCLING CONTAINERS/LID

RUBBERMAID

Round Containers

Recycling container without lid. Contains Post-Consumer Recycled Resin (PCR) exceeding EPA guidelines. Transport recyclable waste with ease and efficiency.

177032061 263206 32 gal., Blue 1/ea.

177026291 263273 32 gal., Blue 1/ea.

177043061 264373 44 gal., Blue 1/ea.

Mobile Office Paper Collection Container

Can serve as central collection containers or shipping containers, reducing the amount of handling. Heavy-duty wheels roll easily, even over steps or curbing. Transport recyclable waste with ease and efficiency.

177026361 263406 32 gal., Blue 1/ea.

Square Recycling Container w/o Lid

Easy-to-manuever. Contains Post-Consumer Recycled Resin (PCR) exceeding EPA guidelines. Can serve as central collection containers or shipping containers, reducing the amount of handling. Transport recyclable waste with ease and efficiency.

177053371 353673 40 gal., 23 1/2" sq. x 28 3/4" H, Blue 1/ea.



C. BRUTE® ROLL OUT RECYCLING

CONTAINER W/LID

RUBBERMAID

Industry leader in waste and material handling applications. Can serve as central collection containers or shipping containers, reducing the amount of handling. Heavy-duty wheels roll easily even over steps or curbing. Transport recyclable waste with ease and efficiency.

177095291 9W2773 50 gal., Blue 1/ea.



D. PAPER RECYCLING CONTAINER

RUBBERMAID

Deskside paper recycling system is designed to be used with existing office containers and accessories. Rubbermaid's office paper recycling system is an easy and effective way to collect waste paper. For use in areas of high paper generation, such as near copiers, printers and in mailrooms. Serves as a convenient central collection site for multiple work stations.

177080011 356806 19 gal., 14 1/2" sq. x 24" H, Blue 1/ea.



E. PLAZA® RECYCLING CONTAINERS

RUBBERMAID

Large capacity recycling containers for any outdoor environment. Contains Post-Consumer Recycled Resin (PCR) exceeding EPA guidelines. Station containers serve as a convenient central collection site for multiple work stations. Recommended for indoor and outdoor use. Large capacity ideal for heavy traffic areas.

17700968 396873 50 gal., 24 3/4" L x 25 1/4" W x 42 1/8" H, Bottle & Can 1/ea.

17700969 396973 50 gal., 25 3/4" L x 25 1/4" W x 42 1/8" H, Paper 1/ea.



DOLLIES

F. HUSKEE™ DOLLIES

CCP

The easy twist-on, twist-off design allows the dolly to fit 20, 32, 44 and 55 gallon Huskee™ rounds. Features five 3" non-marking swivel casters.

276032551 3255 18" dia. x 5"H, Black 1/ea.

27603255 3255 18" dia. x 5"H, Black 2/cs.



G. BRUTE® DOLLIES

RUBBERMAID

Easy mobility and maneuverability of heavy loads. Up to 350 lb. continuous static load rating. All plastic construction resists rust, chipping and denting. Heavy-duty wheels with swivel capabilities provide for ease of mobility.

177077321 2640 Fits 20, 32, 44 & 55 gal. Brute 1/ea.

17707732 2640 Fits 20, 32, 44 & 55 gal. Brute 2/cs.



CAN LINERS & CONTAINERS

Dollies/Caddy/Accessories



A. BRUTE® SQUARE DOLLY RUBBERMAID

Easy mobility and maneuverability of heavy loads. All plastic, professional-grade construction resists rust, chipping and denting. Heavy-duty wheels with swivel capabilities provide for ease of mobility.

177001201	3530	300 lb., Black	1/ea.
17700120	3530	300 lb., Black	2/cs.



B. BRUTE® TRAINABLE DOLLY & HANDLE RUBBERMAID

Triple your productivity, move three separate Brute® containers at once. Pull handle accessory (#2652) attaches to rim of 44 gal. or 55 gal. Brute® containers when not in use. Tilt stabilizer provides an easy way to tilt containers for trash removal.

17707769	265103	Dolly, 250 lb., Black	2/cs.
17707771	2652	Handle, Black	2/cs.



C. BRUTE® UNIVERSAL DRUM DOLLY RUBBERMAID

All plastic, professional-grade construction resists rust, chipping and denting. Heavy-duty wheels with swivel capabilities provide for ease of mobility.

17707758	2650	24 ³ / ₈ " dia. x 7 ¹ / ₈ "H, Black	2/cs.
----------	------	---	-------



D. TANDEM BRUTE® DOLLY RUBBERMAID

Easy mobility and maneuverability of heavy loads. Allows for a combination of different size Brute® containers to suit your needs. Containers can be nested and dolly folded upright for space-saving storage. Heavy-duty 8" wheels and swivel casters. Innovative center hinge design and fixed wheels facilitate smooth transport of uneven loads.

17703538	2646	20 ¹ / ₄ "W x 45"D x 8"H, Black	1/ea.
----------	------	---	-------

CADDY/ACCESSORIES



E. HUSKEE™ CADDY BAG CCP

Add this adjustable nine pocket caddy bag to a round or square Huskee™ receptacle. Made of nylon reinforced PVC for years of reliable service.

276031751	3175	22" x 19 ¹ / ₂ ", Yellow	1/ea.
27603175	3175	22" x 19 ¹ / ₂ ", Yellow	6/cs.



F. BRUTE® CADDY BAG RUBBERMAID

Snaps securely onto the rim of Brute® 44 gal. containers (2643 and 2643-60). Durable nylon reinforced vinyl is strong and easy to keep clean. Twelve pockets of various sizes to accommodate most cleaning supplies.

177077361	2642	20" dia. x 20 ¹ / ₂ "H, Yellow	1/ea.
17707736	2642	20" dia. x 20 ¹ / ₂ "H, Yellow	6/cs.



G. BRUTE® RIM CADDY RUBBERMAID

Snaps securely onto the rim of Brute® 44 gal. containers (2643 and 2643-60). User-friendly handles for easy maneuverability and minimal contact with refuse. Easily attach and remove poly-liners. Efficiently dispense smaller liners from inside Brute® container. Spots for bottles wet-floor signs, sponges, lobby dust pan, brushes, liner rolls, gloves, and whatever else you can imagine. Bottles, wet-floor sign and other tools stay in place when bag is unloaded in a full tipped position or an upright position.

17709117	9W87	32 ¹ / ₂ "L x 26 ¹ / ₂ "W x 6 ³ / ₄ "H, Yellow	1/ea.
----------	------	--	-------

Ash/Trash Containers & Smoking Receptacles



ASH/TRASH CONTAINERS & SMOKING RECEPTACLES

A. LANDMARK SERIES™ CONTAINERS/PANELS RUBBERMAID

Container

Heavy gauge hot dipped galvanized steel provides corrosion resistance. Stone panels have Class A fire rating. Coordinated panels included with product. Ideal for indoor and outdoor applications. UV-stabilized powder coat finish protects color and helps extend product life. Ash/trash sand top.

17703979 3973BRN 12 gal., 13 1/2" x 34"H, Brown 1/ea.

Dome Top Containers

Hinged hood with a stay-open strap for easy access to rigid liner. Rainhood cover with openings on all four sides for convenient refuse collection. Aggregate panels sold separately. Sable.

17700318 3970SBLE 35 gal., 26" sq. x 40"H 1/ea.

17708069 3975SBLE 50 gal., 26" sq. x 46 1/2"H, w/Rigid Liner 1/ea.

Aggregate Panel

17704004 4004ROCK Fits 50 gal., River Rock 4/cs.



B. ASH/TRASH CLASSIC CONTAINER RUBBERMAID

Combines waste and smoking management. Designed for indoor and protected outdoor environments. Ashtray can be permanently attached or left unattached for easy emptying. Rugged construction resists dents and scratches. Retainer hardware secures and conceals polyliner bags. Textured finish helps minimize appearance of surface scratches. California State Fire Marshal (CSFM) approved for fire safety.

17708288 818288BEIG 25 gal., Beige, w/o Doors 1/ea.

C. DURAMOLD® SMOKING URNS RUBBERMAID

Duramold® smoking urn with metal ashtray top blends easily with furniture and fixtures.

17707664 2585BLA 11 1/2" dia. x 19 1/2"H, Black 1/ea.

Smoking Urn + Ash/Trash

Duramold® smoking urn with waste receptacle blends easily with furniture and fixtures. Metal ashtray top and metal liner.

17702586 2586BLA 12 1/2" dia. x 19 1/2"H, Black 1/ea.

D. GROUNDSKEEPER™ CIGARETTE WASTE COLLECTORS RUBBERMAID

Classic style, all-weather solution to an unsightly environmental problem. Restricted opening shields cigarette butts from view, weather and flow of oxygen. Two-piece design makes cleaning quick and easy. Inner galvanized steel canister securely holds large quantities of cigarette waste. Constructed of smooth injection molded plastic, rust resistant and easy-to-clean. Steel base plate adds weight for stability and discourages theft.

17702574 257088BEIG Beige 1/ea.

17702573 257088BLA Black 1/ea.

E. GROUNDSKEEPER™ TUSCAN SMOKING RECEPTACLE RUBBERMAID

Tuscan Style, combines clean good looks with easy Groundskeeper™ maintenance. Upscale aesthetic blends with many architectural styles. Stainless steel snuff plate minimizes smoldering. Anchor holes for added security. Inner galvanized steel canister securely holds large quantities of cigarette waste.

17709126 9W30BLA Black 1/ea.

F. INFINITY™ TRADITIONAL SMOKING RECEPTACLE RUBBERMAID

Sophisticated styling and all-metal construction for attractive and efficient smoking litter management. Includes unobstructed funnels to reduce jamming during cigarette disposal. High-capacity receptacle for heavy traffic areas. Stainless steel snuff plate minimizes smoldering. Weighted bases and bolt-down options for added stability outdoors. 360° disposal area. Guidance tabs on collars and bases enable simple removal and reattachment of receptacles during cleaning. Domed tops for weather resistance. Integrated padlock tabs provide security against tampering and theft.

17700020 9W33BLA Holds 5000 Cigarettes, 39"H, Black 1/ea.



Smoking Receptacles/Utility Trucks



CAN LINERS & CONTAINERS



A. INFINITY™ WALL-MOUNT SMOKING RECEPTACLE RUBBERMAID

Sophisticated styling and all-metal construction for attractive and efficient smoking litter management. Includes unobstructed funnels to reduce jamming during cigarette disposal. High-capacity receptacle for heavy traffic areas. Stainless steel snuff plate minimizes smoldering. Weighted bases and bolt-down options for added stability outdoors. 360° disposal area. Guidance tabs on collars and bases enable simple removal and reattachment of receptacles during cleaning. Domed tops for weather resistance. Integrated padlock tabs provide security against tampering and theft. Stainless steel/black.

17700037 9W32SSBLA 2/3 gal., 11⁵/₈"W x 18"H 1/ea.

UTILITY TRUCKS



B. HUSKEE™ TILT TRUCK CCP

Features one-piece extra-strong seamless industrial plastic construction. Narrow width allows for use through standard office doorways. Inset wheel placement prevents wall/door damage and allows for nesting in storage. Molded plastic handle provides a more ergonomic grip, increasing comfort and control. Three strategically positioned hand grips make dumping a breeze. All exposed parts are protected by rust-preventive enamel.

27605841 58401 750 lb., 5/8 cu. yd., Blue/Recycle, Standard 1/ea.



C. TILT TRUCK CCP

Equipped with deluxe roller bearing wheels and heavy-duty casters. Wheels are inset to fit standard office doorways and to reduce wall and door damage. This tilt truck is easily handled by one person and can be easily cleaned with steam or high pressure hot water.

27608338 5833BK 800 lb., 1.1 cu. yd., Black, Standard 1/ea.



D. TILT TRUCK CCP

Features one-piece extra strong seamless industrial plastic construction. Inset wheel placement prevents wall/door damage and allows for nesting in shipment and in storage. Fits through standard office doorways. Cover available.

27608398 5839BK Utility, 300 lb., Black 1/ea.



E. CUBE TRUCKS RUBBERMAID

Efficient for commercial waste collection and bulk material transport. Hinged design allows access without removing lid. Metal frame provides durable support. Conceals loads without reducing capacity. USDA Meat & Poultry Equipment Group Listed. Assists in complying with HACCP guidelines. Diamond wheel placement for maneuverability.

17700307 4612BLA 400 lb., 42³/₄" x 28" x 33", Black 1/ea.
17704621 4616 500 lb., 43³/₄" x 31" x 37", Black 1/ea.
17704622 4619 600 lb., 48" x 34¹/₈" x 36¹/₂", Black 1/ea.



F. HEAVY-DUTY UTILITY TRUCKS RUBBERMAID

Metal reinforced truck for heavy-duty waste management, bulk handling and food processing. Diamond wheel placement for maneuverability. Optional domed lid does not reduce storage capacity and a hinged design allows access without removing lid.

4" Casters
17704712 4712 800 lb., 43¹/₈"L x 28"W x 33⁷/₈"H 1/ea.
5" Casters
17704716 4716GRAY 1000 lb., 44²/₈"L x 31"W x 38¹/₈"H, Gray 1/ea.
17704720 4720GRAY 1200 lb., 48¹/₈"L x 34"W x 37⁷/₈"H, Gray 1/ea.

G. MEGA BRUTE® MOBILE WASTE COLLECTOR/LID RUBBERMAID

A highly maneuverable and versatile waste collection and sortation system. Innovative design features deliver improved productivity and ease of use. Highly maneuverable "diamond" wheel and caster pattern. Ergonomic, easy-access rear doors. Waste sortation options with Slim Jim® containers and can liner retainer. Integrated storage for cleaning. Highly aesthetic, sleek design. Optional full coverage, hinged lid. Black.

17709076 9W73 120 gal./400 lb., 27¹/₂"W x 52¹/₂"L x 42¹/₂"H 1/ea.
17709075 9W72 Lid Only, Fits 9W73 1/ea.

Utility & Platform Trucks



A. SPRING PLATFORM TRUCK RUBBERMAID

For waste collection, material transport, and laundry handling. Spring platform brings contents to a convenient working level for safer and less-fatiguing handling of material. Metal frame provides durable support. Conceals loads without reducing capacity. X-Colors (Dark Blue, Red, Yellow, White) available on selected SKUs. USDA Meat and Poultry Equipment Group Listed. Assists in complying with HACCP guidelines. Diamond wheel placement for maneuverability.

17704611 4611 500 lb., 44¹/₈" x 31" x 32¹/₂", 14 cu. yd. 1/ea.



B. STRUCTURAL FOAM TILT TRUCK RUBBERMAID

Durable molded truck handles heavy loads with ease. Fits through standard commercial doorways and onto elevators easily. Non-marking casters reduce touch-up cleaning. Constant force design allows for controlled dumping by one person. Easy-to-clean and virtually maintenance free. Unique steering wheel handle provides excellent maneuvering capability.

17701012 1011 600 lb., 64¹/₂" x 30¹/₄" x 38" 1/ea.



C. TILT TRUCKS RUBBERMAID

Sturdy, plastic construction weighs much less than metal. Easy to handle and maneuver through commercial doorways and onto elevators. Constant force design allows for controlled dumping by one person. Inset wheels protect walls, fixtures and patrons. Smooth surface is easy-to-clean and resists pitting and corroding. Optional domed lids available.

Standard-Duty

17701308	130506	1/2 cu. yd., 750 lb., Dark Blue	1/ea.
17701305	1305GRAY	1/2 cu. yd., 750 lb., Gray	1/ea.
17701301	1305BLA	1/2 cu. yd., 850 lb., Black	1/ea.
17701322	1315BLA	1 cu. yd., 1250 lb., Black	1/ea.
17707318	1025	1 ¹ / ₂ cu. yd., 1000 lb., Black	1/ea.

Utility-Duty

17701319	1304	450 lb., 56 ³ / ₄ " x 28" x 38 ⁵ / ₈ ", 1/2 cu. yd.	1/ea.
17701320	1314	850 lb., 72 ¹ / ₄ " x 33 ¹ / ₂ " x 43 ³ / ₄ ", 1 cu. yd.	1/ea.

Heavy-Duty

17701324	1306BLA	1/2 cu. yd., 1200 lb., Black	1/ea.
17701309	1306G1/2	1/2 cu. yd., 1400 lb., Gray	1/ea.

Lid

Domed, hinged lid for 1 cu. yd. (1314, 1315, 1315-42, 1316, 1316-41, 9T18) tilt trucks.

177013231 1317BLA 69¹/₂" x 34" x 8¹/₂", Black 1/ea.



D. TILT TRUCKS RUBBERMAID

Industrial strength construction transports heavy loads with ease. Seamless one-piece molded truck bodies with reinforced lip. Sturdy, plastic construction won't rust, dent, chip, or peel and is easy-to-clean. 4" center swivel back caster provides easy maneuvering. Durable one piece, 10" blow-molded polypropylene inset wheels protect surroundings. Powder coated steel frame for corrosion resistance.

177017001	9T17BLA	1/2 cu. yd., 300 lb., Black	1/ea.
17701800	9T18BLA	1 cu. yd., 600 lb., Black	1/ea.



PLATFORM TRUCKS

E. PLATFORM TRUCK CCP

Structural plastic sides add protection against wall and door damage; no bumpers required. Two swivel and two fixed casters provide maximum maneuverability. Heavy-duty, reinforced steel handle. 5" casters.

27605860 5860 700 lb., 24" x 48" Deck, Gray, Utility 1/ea.



CAN LINERS & CONTAINERS

Platform Trucks



A. PLATFORM TRUCKS

RUBBERMAID

Built for durability. Sturdy structural foam construction won't rust, dent or splinter. Virtually maintenance free. Crossbar handle.

Rubber Casters

17704403	4403	500 lb., 24" x 36", Black	1/ea.
17704433	4433	500 lb., 24" x 48", Gray	1/ea.
17704436	4436	1000 lb., 24" x 48", Black	1/ea.
17704466	4466	1000 lb., 30" x 60", Gray	1/ea.

Polyolefin Casters

17700170	4471	2000 lb., 30" x 60", Gray	1/ea.
-----------------	------	---------------------------	-------



B. TRIPLE® STANDARD DUTY TROLLEY

RUBBERMAID

Efficiently transports large bulky loads and then folds flat for easy storage. Sturdy structural foam deck won't rust, dent, chip or peel. Non-skid platform surface helps prevent load shifting. Tough plastic construction is easy on walls and doors. Three-position user-friendly handle lets users push, pull or fold flat for use as a dolly. 5" casters are non-marking.

17704405	4401BLA	400 lb., 32½"L x 20½"W, Black	1/ea.
-----------------	---------	-------------------------------	-------

Floor Pads

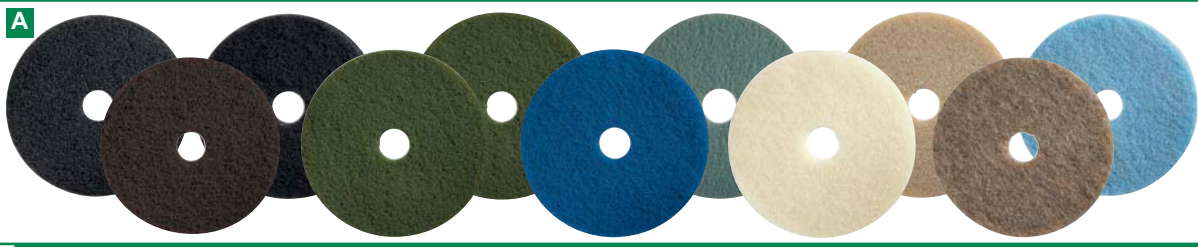

FLOOR PADS

A. FLOOR PADS

PRIME SOURCE®

Black Stripping Pads

For long-lasting, heavy-duty stripping.

75004989	75004989	12", Black	5/cs.
75004425	75004425	13", Black	5/cs.
75004392	75004392	14", Black	5/cs.
75004404	75004404	15", Black	5/cs.
75004395	75004395	16", Black	5/cs.
75004434	75004434	17", Black	5/cs.
75004398	75004398	18", Black	5/cs.
75004442	75004442	19", Black	5/cs.
75004451	75004451	20", Black	5/cs.
75004459	75004459	21", Black	5/cs.

Brown Stripping Pads

For stripping heavy-soiled traffic areas such as halls and stairs. Easily removes old finish and wax build-up.

75004411	75004411	13", Brown	5/cs.
75004419	75004419	14", Brown	1/ea.
75004985	75004985	20", Brown	5/cs.

Dark Blue Saffire™ Maximum Performance Stripping Pads

Highly abrasive for maximum stripping power. Recommended for use on machines operating at 175-350 RPM.

75004970	75004970	13", Dark Blue	5/cs.
75004971	75004971	17", Dark Blue	5/cs.
75004446	75004446	20", Dark Blue	5/cs.

Maximum Performance Stripping Pad

Highly abrasive for maximum stripping power. Recommended for use on machines operating at 175-350 RPM.

75004428	75004428	17", Dark Blue	5/cs.
----------	----------	----------------	-------

Emerald II Stripping Pads

For use with stripping solution to remove even the toughest heel marks and heavy finish buildup. Features include: super open web, highly abrasive, tear resistant, durable and tough and increased efficiency. Durable and aggressive for the toughest stripping jobs.

75004416	75004416	13", Emerald Green	5/cs.
76007860	76007860	16", Emerald Green	5/cs.
75004417	75004417	17", Emerald Green	5/cs.
75004418	75004418	20", Emerald Green	5/cs.

Green Scrubbing Pads

For wet, heavy-duty scrubbing.

75004495	75004495	14", Green	5/cs.
75004426	75004426	13", Green	5/cs.
75004393	75004393	16", Green	5/cs.
75004435	75004435	17", Green	5/cs.
75004443	75004443	19", Green	5/cs.
75004452	75004452	20", Green	5/cs.
75004460	75004460	21", Green	5/cs.

A. FLOOR PADS (CONT.)

PRIME SOURCE®

Blue Cleaning Pads

Designed for moderate scrubbing or heavy spray cleaning. Use with machine speeds of 175-300+RPM.

75004424	75004424	13", Blue	5/cs.
75004972	75004972	14", Blue	5/cs.
75004403	75004403	15", Blue	5/cs.
75004433	75004433	17", Blue	5/cs.
75004976	75004976	18", Blue	5/cs.
75004441	75004441	19", Blue	5/cs.
75004450	75004450	20", Blue	5/cs.
75004458	75004458	21", Blue	5/cs.

Aqua Burnisher Pads

A superior soft pad that lightly polishes the floor for a reflective appearance. Recommended for use on machines operating at 1000-3000+ RPM.

75004973	75004973	19", Aqua	5/cs.
75004471	75004471	20", Aqua	5/cs.
75004974	75004974	20", Aqua	5/cs.
75004975	75004975	24", Aqua	5/cs.
75004472	75004472	27", Aqua	5/cs.

Beige UHS Burnishing Pads

A moderately soft burnishing pad for a softer finish.

75004423	75004423	13", Beige	5/cs.
75004432	75004432	17", Beige	5/cs.
75004440	75004440	19", Beige	5/cs.
75004449	75004449	20", Beige	5/cs.
75004457	75004457	21", Beige	5/cs.
75004408	75004408	24", Beige	5/cs.
75004466	75004466	27", Beige, 3/4" CH	2/cs.
75004465	75004465	27", Beige, 1/4" BH	5/cs.

Champagne UHS Burnishing Pads

For wet, medium-duty scrubbing.

75004438	75004438	19", Champagne	5/cs.
75004454	75004454	20", Champagne	5/cs.
75004409	75004409	24", Champagne	5/cs.
75004412	75004412	27", Champagne, 1/4" BH	2/cs.
75004413	75004413	27", Champagne, 3/4" CH	2/cs.

Heavy-Duty UHS Burnishing Pads

Top quality, natural hair burnishing pad with a hard and aggressive binder. Use with machine speeds of 1000-3000+ RPM.

75004977	75004977	17", Natural	5/cs.
75004978	75004978	19", Natural	5/cs.
75004475	75004475	20", Natural	5/cs.
75004479	75004479	27", Natural	1/ea.

Light Blue UHS Burnishing Pads

Use where burnishing is required on a frequent basis. Soft binders with fine synthetic fiber create a super soft pad for dry burnishing.

75004437	75004437	19", Light Blue	5/cs.
75004445	75004445	20", Light Blue	5/cs.
75004397	75004397	21", Light Blue	5/cs.
75004410	75004410	24", Light Blue	5/cs.
75004414	75004414	27", Light Blue, 1/4" BH	2/cs.
75004415	75004415	27", Light Blue, 3/4" CH	2/cs.

FLOOR EQUIPMENT

Floor Pads



FLOOR EQUIPMENT

A. FLOOR PADS (CONT.)

PRIME SOURCE®

Natural Hair UHS Burnishing Pads

A blend of synthetic fibers and natural hair. Pads last longer with lubricating effect of a hair pad.

75004430	75004430	17", Natural	5/cs.
75004391	75004391	17", Natural, Light-Duty	5/cs.
75004470	75004470	18", Natural, Light-Duty	5/cs.
75004421	75004421	19", Natural	5/cs.
75004984	75004984	19", Natural, Light-Duty	5/cs.
75004447	75004447	20", Natural	5/cs.
75004399	75004399	20", Natural, Light-Duty	5/cs.
75004455	75004455	21", Natural	5/cs.
75004986	75004986	21", Natural, Light-Duty	5/cs.
75004473	75004473	24", Natural	5/cs.
75004987	75004987	24", Natural, Light-Duty	5/cs.
75004979	75004979	27", Natural	5/cs.
75004463	75004463	27", Natural, 1/4" BH	2/cs.
75004464	75004464	27", Natural, 3/4" CH	2/cs.
75004474	75004474	27", Natural, Light-Duty	2/cs.
75004491	75004491	27", Natural, Light-Duty	5/cs.

Natural Coco UHS Pads

Coconut fibers are both organic and biodegradable. Recommended for use on machines operating at 1500-3000+ RPM.

75004990	75004990	17", Natural	5/cs.
75004991	75004991	19", Natural	5/cs.
75004992	75004992	20", Natural	5/cs.
75004993	75004993	21", Natural	5/cs.

Red Spray Buffing Pads

Used in dry buffing and spray buffing or light scrubbing applications.

75000042	75000042	12", Red	5/cs.
75004980	75004980	12", Red	5/cs.
75004427	75004427	13", Red	5/cs.
75004429	75004429	14", Red	5/cs.
75004406	75004406	15", Red	5/cs.
75004407	75004407	16", Red	5/cs.
75004436	75004436	17", Red	5/cs.
75004981	75004981	18", Red	5/cs.
75004444	75004444	19", Red	5/cs.
75004453	75004453	20", Red	5/cs.
75004461	75004461	21", Red	5/cs.

Polishing Pad

Produces a sparkling shine. Use with 175-300 RPM machines.

75004997	75004997	20", Tan	5/cs.
----------	----------	----------	-------

White Super Polishing Pads

Produces a high-gloss, "wet-look" shine in polishing applications.

75004422	75004422	13", White	5/cs.
75004405	75004405	14", White	5/cs.
75004401	75004401	15", White	5/cs.
75004394	75004394	16", White	5/cs.
75004431	75004431	17", White	5/cs.
75004469	75004469	18", White	5/cs.
75004439	75004439	19", White	5/cs.
75004448	75004448	20", White	5/cs.
75004456	75004456	21", White	5/cs.
75004462	75004462	27", White, 3/4" CH	2/cs.

B. FLOOR PADS

CCP

Conventional Thickline Stripping Pads

For long lasting, heavy-duty stripping. Recommended for use on machines operating at 175-350 RPM.

27600483	20006	12", Black	5/cs.
27600088	20007	13", Black	5/cs.
27600380	20009	15", Black	5/cs.
27600113	20010	16", Black	5/cs.
27600387	20012	18", Black	5/cs.
27600498	20013	19", Black	5/cs.
27600446	20014	20", Black	5/cs.
27600386	20016	22", Black	5/cs.

Conventional Scrubbing Pad

Designed for heavy-duty wet scrubbing to remove surface coat, ground-in dirt and scuff marks. Use with machine speeds of 175-300+ RPM.

27600497	20128	17", Green	5/cs.
----------	-------	------------	-------

Conventional Thickline Cleaning Pads

For wet, medium-duty scrubbing. Recommended for use on machines operating at 175-300 RPM.

27600469	20204	15", Blue	5/cs.
27600475	20205	16", Blue	5/cs.
27600096	20206	17", Blue	5/cs.
27600097	20209	20", Blue	5/cs.

Buckaroo™ UHS Burnishing Pads

A natural hair pad that excels in bringing out the luster on softer, buffable floor finishes. Use with machines operating at 1000-3000+ RPM.

27600313	20365	21", Natural	5/cs.
27600318	20368	24", Natural	5/cs.
27600422	23624	27", Natural, 3/4" BH	2/cs.

Jackeroo™ UHS Burnishing Pad

A correct blend of natural hair and synthetic fibers. Longer lasting with the lubricating effect of a hair pad. Use with machine speeds of 1000-3000+ RPM.

27600395	20403	20", Natural	5/cs.
----------	-------	--------------	-------

Jackeroo Lite™ UHS Burnishing Pad

A natural hair pad that excels in bringing out the luster on softer, buffable floor finishes. Recommended for use on machines operating at 1000-3000+ RPM.

27600322	20442	20", Natural	5/cs.
----------	-------	--------------	-------

Conventional Thickline Spray Buffing Pads

For dry buffing, spray buffing or light-duty scrubbing. Recommended for use on machines operating at 175-300 RPM.

27600094	20046	13", Red	5/cs.
27600116	20047	14", Red	5/cs.
27600111	20049	16", Red	5/cs.
27601975	20050	17", Red	5/cs.
27600296	20051	18", Red	5/cs.
27600300	20052	19", Red	5/cs.
27600085	20053	20", Red	5/cs.
27600492	20054	21", Red	5/cs.

Floor Pads/Bonnets/Vacuums



A. MICROTRON® POLISHING PAD CCP

An ideal pad for light cleaning and dry buffing, producing a sparkling shine. Use with 175-300 RPM machines.

27600402 13313 13", Tan 5/cs.



B. SUPER POLISHING PAD CCP

For dry polishing or with fine water mist to ensure high gloss. Recommended for use on machines operating at 175-350 RPM.

27600448 20090 18", White 5/cs.



C. WHITE SUPER POLISHING PADS CCP

For dry polishing or with water to ensure a high gloss. Recommended for use on machines operating at 175-350 RPM.

27603247 14413 13", White 5/cs.

27604414 14414 14", White 5/cs.

27604417 14417 17", White 5/cs.

27604419 14419 19", White 5/cs.

27604420 14420 20", White 5/cs.



BONNETS

D. KING COTTON BONNET™ CARPET BONNETS PRIME SOURCE®

Thick profile pad with looped-end, small diameter cotton yarn provides maximum absorption.

750047861 75004786 17", White 1/ea.

75004786 75004786 17", White 6/cs.

750047871 75004787 19", White 1/ea.

75004787 75004787 19", White 6/cs.



E. QUEEN BONNET™ CARPET BONNETS PRIME SOURCE®

Medium profile pad with aggressive scrubbing strips. Constructed of absorbent blended looped-end yarn for extra durability.

75004789 75004789 17", White/Green 6/cs.

75004790 75004790 19", White/Green 6/cs.

75004788 75004788 21", White/Green 6/cs.



F. SPIN KLEAN® P-4 BONNETS W/SCRUB STRIPS RUBBERMAID

Low-profile bonnet with scrub strips adds additional scrubbing action for improved cleaning performance. Use with a standard rotary floor machine for intensive carpet maintenance.

177005551 P267 17", White/Green 1/ea.

17700555 P267 17", White/Green 5/cs.

17700269 P269 19", White/Green 5/cs.

17700078 P271 21", White/Green 5/cs.



VACUUMS

G. BACKPACK VACUUM CLEANER RUBBERMAID

Lightweight with comfortable harness design. Narrow profile for unrestricted mobility. Very quiet operation for day cleaning. Four stage filtration system. Closed bag design and security latches for cleaner air, no leaks. 50' 3-wire cord. Flexible hose, crevice tool, floor tool, aluminum wands, dusting brush, and upholstery tool included. CRI Green Label certification for improved indoor air quality. 110 CFM, 100" Waterlift, 8A.

17700983 9VBP06 6 qt., 11½"L x 13"W x 21⅞"H 1/ea.



H. MANUAL HEIGHT UPRIGHT VACUUM CLEANERS RUBBERMAID

Nozzle easily removes for service; no tools required for assembly. Easy to replace bags, brush rollers, and filters. Easy to remove clogs. Electronic indicator lights for full bag and brush jam warnings. On-board tool storage. Optional HEPA filtration kit. CRI Green Label certification for improved indoor air quality. 105 CFM, 98" Waterlift, 10A.

17700988 9VMH12 12"W x 12⅝"D x 46"H, 12" Path 1/ea.

17700987 9VMH15 15"W x 12⅝"D x 46"H, 15" Path 1/ea.



Vacuums/Indoor Sweepers/Scraper Mats



FLOOR EQUIPMENT



A. POWER HEIGHT UPRIGHT VACUUM CLEANERS RUBBERMAID

Automatic carpet height adjustment for increased productivity. Industry leading 1.8 hp dual motor vacuum provides one pass cleaning, maximizing cleaning performance. Electronic indicator lights for full bag and brush jam warnings. Nozzle easily removes for service; no tools required for assembly. Easy to replace bags, brush rollers, and filters. Easy to remove clogs. On-board tool storage. Optional HEPA filtration kit. CRI Green Label certification for improved indoor air quality. 105 CFM, 98" Waterlift, 11A.

17700998	9VPH12	12"W x 13 ¹ / ₂ "D x 46"H, 12" Path	1/ea.
17700996	9VPH15	15"W x 13 ¹ / ₂ "D x 46"H, 15" Path	1/ea.



B. TRADITIONAL UPRIGHT VACUUM CLEANERS RUBBERMAID

Easy-empty paper bag within cloth bag and bag collar seal for improved indoor air quality. 50' power cord. Six-position carpet height adjustment. Durable metal handle tube and bottom plate. Robust furniture guard. CRI Green Label certification for improved indoor air quality. 156.5 CFM, 7A.

17700986	9VCV12	13 ¹ / ₁₀ "W x 16 ¹ / ₂ "D x 46 ¹ / ₁₀ "H, 12" Path	1/ea.
17700984	9VCV16	17 ² / ₅ "W x 16 ¹ / ₂ "D x 46 ¹ / ₁₀ "H, 16" Path	1/ea.



C. ULTRA LIGHT UPRIGHT VACUUM CLEANER RUBBERMAID

Weighs less than 10 lbs. (without cord). Built-in, center-balanced, "easy-carry" handle. Floating nozzle enables cleaning of both hard and soft floor surfaces. 40' power cord. Large outboard wheels improve maneuverability. No tools required for assembly. Unique extension cord hook allows easy connection to the extension cord. CRI Green Label certification for improved indoor air quality. 79.5 CFM, 4A.

17700999	9VUL12	12 ¹ / ₂ "W x 9 ² / ₅ "D x 46 ² / ₅ "H, 12" Path	1/ea.
-----------------	--------	--	-------

INDOOR SWEEPERS



D. HUSKEE™ POWERROTOR™ FLOOR SWEEPER CCP

Floor sweeper cleans hard floors and carpets. The self-cleaning flexible rubber blades beat the floor with high frequency, creating friction and momentum that cleanly transports dirt, food, lint and other debris into the dust compartments. Durable plastic body resists scratches and dents and is easy on walls, doors and furniture.

276053271	5325	9 ¹ / ₂ " Path	1/ea.
27605327	5325	9 ¹ / ₂ " Path	5/cs.



E. BRUSHLESS MECHANICAL SWEEPER RUBBERMAID

Perfect for food service applications. Low profile for easy maneuverability and cleaning under furniture. Clear tinted window tells you when the sweeper needs emptying. Two debris canisters with one-touch emptying doors. Four natural boar bristle corner brushes for fine cleaning.

17700023	4215	7 ¹ / ₂ " Path	4/cs.
-----------------	------	--------------------------------------	-------



F. FLOOR/CARPET SWEEPER RUBBERMAID

Natural boar-bristle brushes in each corner. Easy open debris pan for effortless cleaning. Constructed of durable galvanized steel and tough ABS plastic. For bare floors or low pile carpets.

17708232	4212GRAY	6 ¹ / ₂ " Path, Gray	4/cs.
-----------------	----------	--	-------

SCRAPER MATS



G. CLEAN STEP SCRAPER MATS MILLENNIUM MAT

All-rubber mat ideal for any outside entryway. The superior molded tread aggressively scrapes shoes clean of dirt and grime and traps it into the base of the mat. Available in black only. Certified slip-resistant by the National Floor Safety Institute.

C5440150	14030500	3' x 5', Black	1/ea.
C5440151	14040600	4' x 6', Black	1/ea.

Indoor Mats/Anti-Fatigue Mats



INDOOR MATS

A. ECOGUARD® INDOOR MATS

MILLENNIUM MAT

Made from 99% recycled material, EcoGuard is the most eco-friendly and ecologically responsible mat ever. Carpeted surface is made from 100% post-consumer PET plastic bottles. The all rubber backing is made from used tires, preventing landfill waste.

C5440200	<i>EG020304</i>	2' x 3', Charcoal	1/ea.
C5440201	<i>EG030504</i>	3' x 5', Charcoal	1/ea.
C5440205	<i>EG030508</i>	3' x 5', Green	1/ea.
C5440202	<i>EG031004</i>	3' x 10', Charcoal	1/ea.
C5440206	<i>EG031008</i>	3' x 10', Green	1/ea.
C5440203	<i>EG040604</i>	4' x 6', Charcoal	1/ea.
C5440207	<i>EG040608</i>	4' x 6', Green	1/ea.

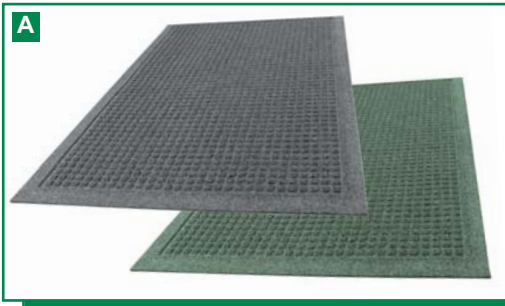

ANTI-FATIGUE MATS

B. FLEX STEP ANTI-FATIGUE MATS

MILLENNIUM MAT

Reduces fatigue and discomfort while increasing productivity. Air domes offer flexible and comfortable support, and low-profile beveled edges reduce the risk of tripping. Accepted by the American Podiatric Medical Association. Certified slip-resistant by the National Floor Safety Institute.

C5440300	<i>24020300</i>	2' x 3', Black	1/ea.
C5440301	<i>24030500</i>	3' x 5', Black	1/ea.



Lightweight & Mediumweight Paper Dinnerware



LIGHTWEIGHT PAPER DINNERWARE

A. PERFECT PAPER PLATES

PRIME SOURCE®

Uncoated paper plate. White.

73001001	73001001	6" dia.	1000/cs.
73001000	73001000	6" dia., Bulk	1000/cs.
73001002	73001002	9" dia.	1000/cs.
73001003	73001003	9" dia.	1200/cs.

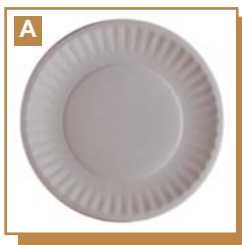

B. NATURE'S OWN GREEN LABEL PAPER PLATES

AJM PACKAGING

White uncoated paper plates. Made from 100% paper; a renewable natural resource.

Microwave safe. 100 ct.

10100110	PP6GRNWH	6" dia.	1000/cs.
10100055	PP9GREWH	9" dia.	1000/cs.
10100111	PP9GRNWH	9" dia.	1200/cs.



C. PAPER PLATES

AJM PACKAGING

White uncoated paper plates. White.

10100060	PP6AJKWH	6" dia., Bulk	1000/cs.
10100068	PP6S6EWH	6" dia., Bulk	1000/cs.
10100054	PP7AJKWH	7" dia.	1000/cs.



D. DIXIE® PAPER PLATES

GEORGIA PACIFIC FOODSERVICE

Economy grade uncoated paper plates. White.

15000064	702622WNP6	6" dia.	1000/cs.
15009902	709902WNP9	9" dia.	1000/cs.



E. BUDGETWARE™ PAPER PLATE

SOLO®

Uncoated paper plate.

10300067	40111	6" dia., Shallow, White, 10 pt - Superior	1000/cs.
----------	-------	---	----------



MEDIUMWEIGHT PAPER DINNERWARE

F. PRIME SOURCE® ENVY® PAPER DINNERWARE

PRIME SOURCE®

For hot and cold foods. Fluted rigid rims for strength. Clay coated. Microwaveable.

75002104	75002104	12 oz., Bowl	1000/cs.
75002130	75002130	12 oz., Bowl	1000/cs.
75002121	75002121	6" dia., Plate, 125 ct.	1000/cs.
75002101	75002101	6" dia., Plate, 250 ct.	1000/cs.
75002102	75002102	7" dia., Plate	1000/cs.
75002122	75002122	8 1/2" dia., Plate	500/cs.
75002123	75002123	9" dia., Plate	500/cs.
75002103	75002103	9" dia., Plate	1000/cs.
75002108	75002108	9" dia., Plate, Heavyweight	1000/cs.



G. BUDGETWARE™ PAPER PLATE

SOLO®

Coated paper plate. 12 pt - superior.

10300066	40944	9" dia., Shallow, White	1000/cs.
----------	-------	-------------------------	----------



H. PAPER PLATE

SOLO®

Our semi-glossy paper dinnerware delivers the quality you have come to expect from Solo®.

Mediumweight. Clay-coated paper.

18201151	MWP9J8001	9" dia., Symphony	1000/cs.
----------	-----------	-------------------	----------

I. SYMPHONY™ PAPER DINNERWARE

SOLO®

Using on-trend colors and a sophisticated pattern, we've created the ultimate look that will enhance every customer's dining experience. Whether you're looking for cups, dinnerware, or containers, Symphony's coordinating pieces offer the perfect single-use solution to complement every meal and beverage.

18201148	MWP6J8001	6" dia., Plate	1000/cs.
18201672	MP9J8001	9" dia., Plate	500/cs.



BOWLS, PLATES & PLATTERS



Heavyweight & Eco-Friendly Paper Dinnerware

BOWLS, PLATES & PLATTERS



HEAVYWEIGHT PAPER DINNERWARE

A. PAPER PLATE

AJM PACKAGING

Coated paper plate.

10100037 CP9AJCWWH14 9" dia., White, Heavy-Duty 500/cs.

B. SUPERWARE®

PAPER DINNERWARE

GEORGIA PACIFIC FOODSERVICE

Patented pressed paper construction and unique 5-layer design with Soak-Proof Shield™ offers extra strength and rigidity. Sage™.

15001691 SX12SAGE 12 oz., Bowl 500/cs.

15001777 SX12SAGE 12 oz., Bowl 1000/cs.

150017795 SXB12SCDX 12 oz., Bowl, WiseSize™ (4/125) 125/cs.

15001779 SXB12SCDX 12 oz., Bowl, WiseSize™ (4/125) 500/cs.

15001720 SX6SAGE 6" dia., Plate, 125 ct. 1000/cs.

15000061 SXP9SCDX 8 1/2" dia., Plate 500/cs.

15001597 SX9SAGE 9" dia., Plate, 125 ct. 500/cs.

15001590 SXP10SAGE 10 1/16" dia., Plate 500/cs.

15000059 SXP10SCDX 10 1/4" dia., Plate 500/cs.



C. ULTRALUX™ PAPER PLATES

GEORGIA PACIFIC FOODSERVICE

Ultralux™ is a terrific plate at a great price. Improved soak and cut resistance. Sage™.

15001774 UX6SAGE 5 7/8" dia. 500/cs.

15001724 UX6SAGE 5 7/8" dia. 1000/cs.

15001775 UX7SCDX 6 7/8" dia. 500/cs.

15001725 UX7SAGE 6 7/8" dia. 1000/cs.

15001690 UX9SAGE 8 3/4" dia. 500/cs.

15001776 UX9SAGE 8 3/4" dia. 1000/cs.

15001778 UX9SAGEPB 9" dia., Boxed 600/cs.



D. PLACESITTER® SELECT

HEAVY-DUTY PAPER DINNERWARE

PACTIV

Coated for extra strength as well as grease and moisture resistance. This durable, heavyweight tableware is oil and moisture-resistant. Placesetter® Select plates are also cut-resistant and work well for any occasion. Plates are safe for use in microwave ovens. Bright white plates are suitable for all food service applications.

16202516 PSP0515PUNPC 12 oz., Bowl 1000/cs.

16202515 PSP0605PUNPCF 6" dia., Fluted Plate 1000/cs.

16202514 PSP0705PUNPC 7" dia., Plate 1000/cs.

16202513 PSP0905PUNPC 8 3/4" dia., Plate 500/cs.

16202512 PSP1005PUNPC 10 1/4" dia., Plate 500/cs.



E. PAPER PLATES

SOLO®

Fluted rigid rim for strength. Clay coated. Microwavable. White.

18700606 DBF6 6" dia. 1000/cs.

18705185 DBF902050 9" dia. 1000/cs.



F. SYMPHONY™ PAPER DINNERWARE

SOLO®

Using on-trend colors and a sophisticated pattern, we've created the ultimate look that will enhance every customer's dining experience. Whether you're looking for cups, dinnerware, or containers, Symphony's coordinating pieces offer the perfect single-use solution to complement every meal and beverage.

18201142 HWB12J8001 12 oz., Bowl 1000/cs.

18201145 HWP9J8001 9" dia., Plate 500/cs.

ECO-FRIENDLY PAPER DINNERWARE

G. ECO-LINE ROUND PLATES

BRIDGE-GATE ALLIANCE GROUP

Made from 100% sugarcane. Heavy-duty. Biodegradable and compostable. FDA approved for food use. Oil, grease, and water resistant. Microwavable. Certified by the Biodegradable Products Institute.

B7280151 ECO06 6" dia. 1000/cs.

B7280152 ECO07 7" dia. 1000/cs.

B7280153 ECO09 9" dia. 500/cs.

B7280154 ECO10 10" dia. 500/cs.



Eco-Friendly Paper Dinnerware



A. NATURAL BROWN DINNERWARE

BRIDGE-GATE ALLIANCE GROUP

Compostable natural fiber take-out packaging. Made from 100% renewable resources. BPI Certified. Designed to disintegrate and biodegrade swiftly and safely in a professionally-managed composting facility.

B7280008	<i>BGW12B</i>	12 oz., Bowl	8/125/cs.
B7280021	<i>BGW24SB</i>	24 oz., Square Bowl	4/125/cs.
B7280020	<i>BGW32SB</i>	32 oz., Square Bowl	2/125/cs.
B7280019	<i>BGW2432L</i>	Lid Fits 24/32 oz. Square Bowl	4/125/cs.
B7280012	<i>BGW06</i>	6" dia., Plate	8/125/cs.
B7280013	<i>BGW07</i>	7" dia., Plate	8/125/cs.
B7280011	<i>BGW09</i>	9" dia., Plate	4/125/cs.
B7280033	<i>BGW93</i>	9" dia., 3-Compt. Plate	4/125/cs.
B7280009	<i>BGW103</i>	10 ¹ / ₄ " dia., 3-Compt. Plate	4/125/cs.
B7280010	<i>BGW10</i>	10 ¹ / ₂ " dia., Plate	4/125/cs.
B7280016	<i>BGW710</i>	7" x 10", Platter	4/125/cs.
B7280015	<i>BGW912</i>	9" x 12", Platter	4/125/cs.



B. PREMIUM DINNERWARE

BRIDGE-GATE ALLIANCE GROUP

Made from 100% sugarcane. Heavy-duty. Biodegradable and compostable. FDA approved for food use. Oil, grease, and water resistant. Microwaveable. Certified by the Biodegradable Products Institute. White.

B7280060	<i>BG12B</i>	12 oz., Bowl	8/125/cs.
B7280050	<i>BG06</i>	6" dia., Plate	8/125/cs.
B7280051	<i>BG07</i>	7" dia., Plate	8/125/cs.
B7280052	<i>BG09</i>	8 ³ / ₄ " dia., Plate	4/125/cs.
B7280054	<i>BG103</i>	10 ¹ / ₄ " dia., 3-Compt. Plate	4/125/cs.
B7280053	<i>BG10</i>	10 ¹ / ₂ " dia., Plate	4/125/cs.
B7280055	<i>BG710</i>	7 ¹ / ₂ " x 10", Platter	4/125/cs.
B7280056	<i>BG912</i>	9" x 12", Platter	4/125/cs.



C. HARVEST COLLECTION™ DINNERWARE

GENPAK

Compostable dinnerware item for foodservice applications. Produced from environmentally friendly, annually renewable resources. Harvest wheat.

34789245	<i>HCD12</i>	12 oz., Bowl	1000/cs.
34789244	<i>HCB24</i>	24 oz., Bowl	200/cs.
34789243	<i>HCB32</i>	32 oz., Bowl	200/cs.
34789241	<i>HCD06</i>	6" dia., Plate	1000/cs.
34789240	<i>HCD09</i>	9" dia., Plate	200/cs.
34789239	<i>HCD39</i>	9" dia., 3-Compt. Plate	250/cs.
34789238	<i>HCD10</i>	10 ¹ / ₄ " dia., Plate	250/cs.
34789237	<i>HCD13</i>	10 ¹ / ₄ " dia., 3-Compt. Plate	250/cs.



D. CHINET® CLASSIC WHITE™ MOLDED FIBER DINNERWARE

HUHTAMAKI

Chinet® Classic White™ premium strength paper tableware is recognized everywhere as a quality product you can rely on for superior strength. Made of 99% reclaimed fiber and is microwaveable. 100% recycled/compostable. Passes BPI/ASTM. Made in the USA. Passes Cedar Grove compostable standards.

Burgundy & Gray

15304628	<i>22506</i>	4 oz., Bowl	2000/cs.
15304644	<i>22507</i>	12 oz., Bowl	1000/cs.
15304603	<i>22501</i>	6" dia., Plate, Pocket	1000/cs.
15304637	<i>22508</i>	6 ³ / ₄ " dia., Plate, Pole	1000/cs.
15304690	<i>22504</i>	7 ¹ / ₂ " x 10", Plate, Pony	500/cs.
15304610	<i>22502</i>	8 ³ / ₄ " dia., Plate, Point	500/cs.
15304640	<i>22509</i>	9 ³ / ₄ " dia., Plate, Poodle	500/cs.
15304612	<i>22510</i>	10 ¹ / ₄ " dia., 3-Compt. Plate, Poplin	500/cs.
15304670	<i>22505</i>	10 ¹ / ₂ " dia., Plate, Poplar	500/cs.

Festival Design

15304658	<i>22607</i>	12 oz., Bowl	1000/cs.
15304605	<i>22601</i>	6" dia., Plate, Poem	1000/cs.
15304615	<i>22608</i>	6 ³ / ₄ " dia., Plate, Powder	1000/cs.
15304609	<i>22602</i>	8 ³ / ₄ " dia., Plate, Polka	500/cs.
15304625	<i>22603</i>	9 ¹ / ₄ " dia., 3-Compt. Plate, Ponder	500/cs.



BOWLS, PLATES & PLATTERS

Eco-Friendly Paper Dinnerware



BOWLS, PLATES & PLATTERS



A. CHINET® CLASSIC WHITE™ MOLDED FIBER DINNERWARE (CONT.) HUHTAMAKI

Festival Design			
15304686	22609	9 ³ / ₄ " dia., Plate, Potash	500/cs.
15304629	22610	10 ¹ / ₄ " dia., 3-Compt. Plate, Poke	500/cs.
15304632	22605	10 ¹ / ₂ " dia., Plate, Porch	500/cs.
15304633	22604	7 ¹ / ₂ " x 10", Oval Platter, Pool	500/cs.
15304646	22618	9 ³ / ₄ " x 12 ¹ / ₂ ", Oval Platter, Potent	500/cs.
White			
15306323	21238	12 oz., Bowl, Village	1000/cs.
15306390	21230	12 oz., Bowl, Vital	1000/cs.
15306395	21229	16 oz., Bowl, Vanish	1000/cs.
15306315	21225	6" dia., Plate, Vacate	1000/cs.
15306330	21226	6 ³ / ₄ " dia., Plate, Veneer	1000/cs.
15301245	21244	6 ³ / ₄ " dia., Plate, Verbal (Cash & Carry)	1000/cs.
15306327	21237	8 ³ / ₄ " dia., Plate, Varsity (Cash & Carry)	500/cs.
15306410	21227	8 ³ / ₄ " dia., Plate, Verdict	500/cs.
15306345	21203	9" dia., Plate, Vessel	500/cs.
15306355	21228	9 ¹ / ₄ " dia., 3-Compt. Plate, Vista	500/cs.
15306325	21232	9 ³ / ₄ " dia., Plate, Vapor	500/cs.
15306360	21204	10 ¹ / ₄ " dia., 3-Compt. Plate, Vestry	500/cs.
15306365	21217	10 ¹ / ₂ " dia., Plate, Venture	500/cs.
15306333	21247	10 ¹ / ₂ " dia., Plate, Vanilla (Cash & Carry)	500/cs.
15306375	21256	7 ¹ / ₂ " x 10", Oval Platter, Vogue	500/cs.
15306370	21257	9 ³ / ₄ " x 12 ¹ / ₂ ", Oval Platter, Vesper	500/cs.

B. PAPER PRO™ NATURALS™ DINNERWARE HUHTAMAKI

Delivers the operational efficiency, sturdiness and customer satisfaction of molded fiber tableware at a price similar to that of paper plates. No need to double-plate, even with large portions. Made of 100% reclaimed fiber and, unlike paper plates with poly coatings, is biodegradable and compostable.

15305774	25774	6" dia., Plate	1000/cs.
15305775	25775	8 ³ / ₄ " dia., Plate	500/cs.
15305776	25776	10 ¹ / ₂ " dia., Plate	500/cs.
15305777	25777	10 ¹ / ₄ " dia., 3-Compt. Plate	500/cs.
15305778	25778	7 ¹ / ₂ " x 10", Platter	500/cs.

C. SAVADAY® MOLDED FIBER DINNERWARE HUHTAMAKI

Molded fiber items are molded paper fiber formed into uniquely shaped products to assure strength and rigidity in foodservice operations. For baked items the pie plates provide the right size for all your needs. Plus, molded fiber items accept excess fats from baked goods, keeping pies flaky.

15301305	21060	45 oz., Round Bowl, White, Echo	500/cs.
15300115	10116	9" dia., Medium Pie Plate	500/cs.
15300120	10117	10" dia., Medium Pie Plate	500/cs.

D. NATURE FRIENDLY® DINNERWARE NATURE FRIENDLY PRODUCTS

Nature Friendly Products' 100% biodegradable and compostable tableware provides consumers with an eco-friendly alternative to traditional disposables. Made from sugar cane bagasse-based renewable resources, they are completely compostable within 50-100 days in home and commercial composting facilities. These products are superior in strength and performance. Non-toxic, hot/cold tolerant, oil and water resistant, microwave and freezer safe.

C6932002	L003	12 oz., Classic Bowl	500/cs.
C6932003	L003R	12 oz., Classic Bowl, Retail Pack	500/cs.
C6932038	L044	13 ¹ / ₂ oz., Classic Bowl	1000/cs.
C6932039	L044R	13 ¹ / ₂ oz., Classic Bowl, Retail Pack	24/25/cs.
C6932022	L027	14 oz., Barreled Bowl	600/cs.
C6932021	L026B	12 oz., Soup/Salad Bowl	500/cs.
C6932001	L001B	16 oz., Soup/Salad Bowl	500/cs.
C6932014	L014B	32 oz., Soup/Salad Bowl	500/cs.
C6933006	B021	5 ¹ / ₂ " x 5 ¹ / ₂ ", Square Bowl	450/cs.
C6931000	P001	6" dia., Ridged Edge Round Plate	1000/cs.
C6931010	P011	7" dia., Plate	1000/cs.

Eco-Friendly Paper Dinnerware



A. NATURE FRIENDLY® DINNERWARE (CONT.)

NATURE FRIENDLY PRODUCTS

C6931011	P011R	7" dia., Plate, Retail Pack	1000/cs.
C6931001	P002	7" dia., Ridged Edge Round Plate	1000/cs.
C6931002	P003	8" dia., Ridged Edge Round Plate	1000/cs.
C6931012	P013	9" dia., Plate	500/cs.
C6931013	P013R	9" dia., Plate, Retail Pack	500/cs.
C6931008	P009	9" dia. (7" x 5" Center), Oval Plate	1000/cs.
C6931003	P005	10" dia., Plate	500/cs.
C6931004	P005R	10" dia., Plate, Retail Pack	500/cs.
C6931005	P007	10" dia., 3-Compt. Plate	500/cs.
C6931006	P007R	10" dia., 3-Compt. Plate, Retail Pack	500/cs.
C6931020	P020	10" dia., Oval Plate	500/cs.
C6931030	P030	12 1/2" dia., Oval Plate	500/cs.
C6932020	L026A	Lid Fits 12 oz. Bowl	500/cs.
C6932023	L028	Lid Fits 14 oz. Barreled Soup	600/cs.
C6932000	L001A	Lid Fits 16 oz. Bowl	500/cs.
C6932013	L014A	Lid Fits 32 oz. Bowl	500/cs.
C6933005	B020	Lid Fits 5 1/2" x 5 1/2" Square Bowl	450/cs.



B. PLACSETPER® PREFERRED™ MOLDED FIBER DINNERWARE

PACTIV

Molded fiber products are biodegradable and meet the ASTM D 6868 standards specifications for compostability. These products are made from sustainable, annually renewable materials that are environmentally friendly. Product is made of a blend of bagasse (sugar cane) and bamboo which are sustainable, annually renewable resources. Soak through resistant design resists grease, moisture and helps eliminate messy leaks. Natural white provides a brilliant, white exterior. Stackable.

16206900	MC50008	8 oz., Bowl	1000/cs.
16206887	MC50012	12 oz., Bowl	1000/cs.
16206884	MC50016	16 oz., Bowl	500/cs.
16206879	MC50006	6" dia., Plate	1000/cs.
16206897	MC5000600001	6" dia., Plate, (Sleeved)	1000/cs.
16206899	MC5000700001	6 3/4" dia., Plate, (Sleeved)	1000/cs.
16206882	MC50009	8 3/4" dia., Plate	500/cs.
16206895	MC50009001	8 3/4" dia., Plate, (Sleeved)	500/cs.
16201577	YMC500110001	8 3/4" dia., 3-Compt. Plate	500/cs.
16206881	MC50010	10" dia., Plate	500/cs.
16206896	MC50044001	10" dia., 3-Compt. Plate	500/cs.
16206888	MC50043	7 1/2" x 10" x 1", Platter	500/cs.
16206898	MC500470001	9 7/8" x 12 1/2" x 1", Platter	500/cs.



C. ECO-FORWARD™ WHITE PAPER PLATE

SOLO®

Bare™ by Solo® paper dinnerware is compostable in commercial composting facilities. Made with renewable resources. SFI (Sustainable Forestry Initiative) certified. ECF (Elementally Chlorine Free) bleaching. Environmental alternative to foam. At least 50% stronger than Solo's standard 9" plates. Deep-well geometry for added security and fewer spills. Strong and soak-through resistant. Microwavable.

10302055	MWP942054	9" dia., White, Mediumweight	500/cs.
----------	-----------	------------------------------	---------



D. DEEP MEAL PLATE/COVER

TRELLIS EARTH™

When you're serving a giant veggie burrito, black beans, and rice, or a taco salad, or any other full fledged entree, you need a food service plate that can make your customers proud to be your customer. Trellis Earth™ means business with this entree platter. It's deep and it's strong; made to stand up to your restaurant demands yet biodegradable and earth friendly.

C4780048	WFD31	10 1/4" dia.	200/cs.
C4780047	WFD32	Plate Cover Fits WFD-31	200/cs.



Eco-Friendly Paper & Plastic Dinnerware



BOWLS, PLATES & PLATTERS



A. BOWLS/LIDS		TRELIS EARTH™	
100% biodegradable. Non-toxic. Microwaveable and steamer-safe.			
C4780046	WFW07	16 oz., Rectangle Bowl	300/cs.
C4780053	WFW09	20 oz., Bowl	300/cs.
C4780051	WFW08	Lid Fits Rectangle Bowl 16 oz.	300/cs.
C4780052	WFW10	Lid Fits 20 oz.	300/cs.

PLASTIC DINNERWARE

B. ARISTOCRAT DINNERWARE/LID		GENPAK	
Crystal finish high impact plastic. Maintains shape throughout meal. Non-absorbent, cut-resistant surface. Leak-proof construction. Space-saving low cube design.			
34780240	70500	5 oz., Bowl, White	1000/cs.
34780260	72100	12 oz., Bowl, White	1000/cs.
34780245	70600	6" dia., Plate, White	1000/cs.
34780250	70900	9" dia., Plate, White	500/cs.
34784060	71000	10 1/4" dia., Plate, White	500/cs.
34780225	71300	10 1/4" dia., 3-Compt. Plate, White	500/cs.
34781010	94010	Dome Lid Fits 10 1/4", Clear	200/cs.



C. SILHOUETTE® PLATES		GENPAK	
Crystal finish high impact plastic dinnerware.			
34780079	BLK06	6" dia., Black	1000/cs.
34780081	BLK09	9" dia., Black	400/cs.
34780082	BLK10	10 1/4" dia., Black	400/cs.
34781313	BLK13	10 1/4" dia., 3-Compt., Black	400/cs.



D. STONEWARE® PREMIUM DINNERWARE		GEORGIA PACIFIC FOODSERVICE	
Stoneware looks and performs like a real plate. Fully microwavable, shape is not distorted and food can be reheated. Strong, soak proof and cut resistant.			
15008122	99985	16 oz., Bowl, Black	250/cs.
15008120	99979	9" dia., Plate, Black	250/cs.
15008121	99981	10 1/4" dia., 3-Compt. Plate, Black	250/cs.



E. FIRST CHOICE® HEAVYWEIGHT PLASTIC TABLEWARE		HUHTAMAKI	
Heavyweight plastic tableware with an upscale, high-shine that will enhance presentation.			
Black			
15301412	81412	12 oz., Bowl	1000/cs.
15300044	81406	6" dia., Round Plate	1000/cs.
15301407	81407	7" dia., Round Plate	1000/cs.
15300045	81409	9" dia., Round Plate	500/cs.
15300410	81410	10 1/4" dia., Round Plate	500/cs.
15301430	81430	10 1/4" dia., 3-Compt. Plate	500/cs.
White			
15300113	81212	12 oz., Bowl	1000/cs.
15301224	81224	24 oz., Bowl	500/cs.
15300131	81232	32 oz., Bowl	500/cs.
15300310	81206	6" dia., Round Plate	1000/cs.
15301207	81207	7" dia., Round Plate	1000/cs.
15300317	81209	9" dia., Round Plate	500/cs.
15300176	81239	9" dia., 3-Compt. Plate	500/cs.
15300319	81210	10 1/4" dia., Round Plate	500/cs.
15300323	81230	10 1/4" dia., 3-Compt. Plate	500/cs.
15301211	81211	11", Oval Platter	500/cs.



F. POPULAR CHOICE® LIGHTWEIGHT PLASTIC TABLEWARE		HUHTAMAKI	
Lightweight plastic dinnerware is an excellent value. White.			
15302205	82205	5 oz., Bowl.	1000/cs.
15302206	82206	6" dia., Round Plate	1000/cs.
15302209	82209	9" dia., Round Plate	500/cs.
15302239	82239	9" dia., 3-Compt. Plate	500/cs.
15302210	82210	10 1/4" dia., 3-Compt. Plate	500/cs.
15302230	82230	10 3/4" dia., 3-Compt. Plate	500/cs.



Plastic & Non-Laminated Foam Dinnerware



A. LID FOR PLASTIC TABLEWARE HUHTAMAKI

High profile lid for round plates.

15309020	89002	Fits 9"	150/cs.
----------	-------	---------	---------

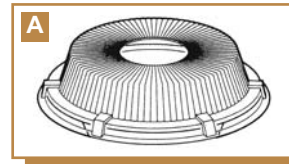

B. HEFTY® PLACESITTER® IMPACT PLATES PACTIV

Heavy, cut resistant, high quality plastic tableware. Black.

16200867	TIBH009	8 ⁷ / ₈ " dia.	400/cs.
16200883	TIBH044	10 ¹ / ₄ " dia., 3-Compt.	400/cs.



C. SOLO® PARTY PLASTIC DINNERWARE SOLO®

The name says party, but for full entrees these plates mean serious business. They are durable, sturdy, and available in colors to fit any occasion or everyday need. Some colors are available in matched service design.

Black

18200439	PSB2E0099	12 oz., Bowl	500/cs.
18204870	P65E0099	6" dia., Plate	500/cs.
18204797	PS95E0099	9" dia., Plate	500/cs.
18204816	PS15E0099	10" dia., Plate	500/cs.

White

18202225	PSB2W0099	12 oz., Bowl	500/cs.
18204765	P65W	6" dia., Plate	1000/cs.
18204795	PS95W0099	9" dia., Plate	500/cs.
18201505	PS15W0099	10" dia., Plate	500/cs.



D. ULTRA CLEAR™ PLASTIC PLATES SOLO®

When you need to dress your food to impress, we recommend top-of-the-line Ultra Clear. This line features heavyweight, cut-resistant plastic and a premium look that's sure to get noticed.

18202065	PT650099	6" dia.	1000/cs.
18204857	PST950099	9" dia.	500/cs.



E. CLASSICWARE® PLATE WNA COMET

The timeless elegance of Classicware® captures the look of fine china, adding a touch of class to any occasion. A heavyweight design makes this attractive dinnerware a durable alternative to china, paper, and foam products.

12200751	CW75180	7 ¹ / ₂ " dia., Clear	180/cs.
----------	---------	---	---------



NON-LAMINATED FOAM DINNERWARE

F. PRIME SOURCE® FOAM PLATES PRIME SOURCE®

Non-laminated foam plates.

75002842	75002842	6" dia.	1000/cs.
75002856	75002856	9" dia., 3-Compt.	500/cs.

G. FOAM BOWLS DART

Dart insulated foam bowls keep hot servings hot and delicious, and cold servings cold and refreshing. Engineered with a rounded spoonable bottom, customers will enjoy every spoonful. White

12502005	5B20	5 oz.	1000/cs.
12502006	6B12	6 oz.	1000/cs.
12502008	8B20	8 oz.	1000/cs.
12500120	10B20	10 oz.	1000/cs.
12502012	12B32	12 oz.	1000/cs.



H. CONCORDE® DINNERWARE DART

Non-laminated foam dinnerware is strong enough to hold a full portion without bending. Superior insulating qualities make it perfect for both hot and cold foods. White.

12505283	9PWC	9" dia., Plate	500/cs.
12505265	12BWWC	10 - 12 oz., Bowl	1000/cs.



Non-Laminated Foam Dinnerware



BOWLS, PLATES & PLATTERS



A. CELEBRITY DINNERWARE GENPAK

Foam insulated non-laminated dinnerware. White.

34784057	<i>80500</i>	5 oz., Bowl	1000/cs.
34784058	<i>82100</i>	12 oz., Bowl	1000/cs.
34784050	<i>80600</i>	6" dia., Plate	1000/cs.
34780700	<i>80700</i>	7" dia., Plate	1000/cs.
34784052	<i>80900</i>	8 ⁷ / ₈ " dia., Plate	500/cs.
34784053	<i>83900</i>	8 ⁷ / ₈ " dia., 3-Compt. Plate	500/cs.
34784054	<i>81000</i>	10 ¹ / ₄ " dia., Plate	500/cs.
34784055	<i>81300</i>	10 ¹ / ₄ " dia., 3-Compt. Plate	500/cs.
34780109	<i>87900</i>	7" x 9", Platter	500/cs.

B. UTILITY BOWL/LID GENPAK

Cut resistant laminated foam dinnerware ensures your products will be served up with style and security every time.

34782402	<i>LW024BK</i>	24 oz., 8 ⁷ / ₈ " dia., Bowl, Black	400/cs.
34782420	<i>LW932</i>	Lid Fits 24/32 oz., Clear	200/cs.



C. PLACESETTER® SATIN FOAM DINNERWARE PACTIV

Satin smooth foam, non-laminated surface.

Vanilla

16200094	<i>TH50004</i>	4 oz./5 oz., Bowl	1000/cs.
16200199	<i>TH50006</i>	6" dia., Plate	1000/cs.

White

16200141	<i>TH10004</i>	4 oz./5 oz., Bowl	1000/cs.
16200159	<i>TH10012</i>	12 oz., Bowl	1000/cs.
16200177	<i>TH10022</i>	22 oz., Bowl	500/cs.
16200166	<i>TH10030</i>	30 oz., Bowl	500/cs.
16200031	<i>TH10006</i>	6" dia., Plate	1000/cs.
16200030	<i>TH10007</i>	7" dia., Plate	1000/cs.
16200032	<i>TH10009</i>	8 ⁷ / ₈ " dia., Plate	500/cs.
16200071	<i>TH10009</i>	8 ⁷ / ₈ " dia., Plate	1000/cs.
16200127	<i>TH10011</i>	8 ⁷ / ₈ " dia., 3-Compt. Plate	500/cs.
16200136	<i>TH10010</i>	10 ¹ / ₄ " dia., Plate	500/cs.
16200138	<i>TH10044</i>	10 ¹ / ₄ " dia., 3-Compt. Plate	500/cs.
16200167	<i>TH10043</i>	8 ¹ / ₂ " x 11 ¹ / ₂ ", Platter	500/cs.
16201253	<i>TH10045</i>	7" x 9", Platter	1000/cs.



D. BASIX® FOAM DINNERWARE SOLO®

Polystyrene unlaminated foam dinnerware. A lightweight and economical choice, the Basix line helps make items like salads and appetizers more profitable. Count on a secure feel with very little bending.

18704690	<i>FS35BY0007</i>	3 ¹ / ₂ oz. Bowl, White,	1000/cs.
18704689	<i>FS5DBY0007</i>	5 oz., Bowl, White	1000/cs.
18704681	<i>FS6BPY0007</i>	6" dia., Plate, White	1000/cs.
18704685	<i>FS9DPY0007</i>	9" dia., Plate, White	500/cs.
18704683	<i>FS9CY0007</i>	9" dia., 3-Compt. Plate, White	500/cs.
18704631	<i>FS79PY0007</i>	9" x 7", Oval Platter, White	500/cs.
18700038	<i>LC9TK</i>	Lid Fits 9" Plates & Platters, Clear	250/cs.



E. HANDI-KUP® UNIVERSAL HOT/COLD BOWLS WINCUP

Smoothwall. Constructed of expandable polystyrene beads. White.

19400289	<i>B8ST</i>	8 oz.	1000/cs.
19400642	<i>B10</i>	10 oz.	1000/cs.
19400643	<i>B12</i>	12 oz.	1000/cs.



Laminated Foam Dinnerware



LAMINATED FOAM DINNERWARE

A. QUIET CLASSIC® PLATES

DART

Laminated for extra strength and gloss. Strong enough to hold a full portion without bending. Superior insulating qualities make foam dinnerware perfect for both hot and cold foods.

12501701	9PWQ	9" dia., White	500/cs.
12505300	10PWQ	10 ¹ / ₄ " dia., White	500/cs.
12500290	10CPHQ	10 ¹ / ₄ " dia., 3-Compt., Honey	500/cs.
12505290	10CPWQ	10 ¹ / ₄ " dia., 3-Compt., White	500/cs.



B. ELITE FOAM DINNERWARE

GENPAK

Cut resistant laminated foam dinnerware ensures your products will be served up with style and security every time.

Black

34780146	LAM09BK	8 ⁷ / ₈ " dia., Plate	500/cs.
34780277	LAM79BK	7" x 9", Platter	500/cs.
34780145	LAM11BK	8 ¹ / ₂ " x 11 ¹ / ₂ ", Platter	500/cs.

White

34780123	LAM09WH	8 ⁷ / ₈ " dia. dia., Plate	500/cs.
34780111	LAM39WH	8 ⁷ / ₈ " dia. dia., 3-Compt. Plate	500/cs.
34780118	LAM10WH	10 ¹ / ₄ " dia. dia., Plate	500/cs.
34780117	LAM13WH	10 ¹ / ₄ " dia. dia., 3-Compt. Plate	500/cs.



C. HEFTY® FOAM PLATE

PACTIV

Sturdy, disposable dinnerware is strong and soakproof.

16201159	D28100	8 ⁷ / ₈ ", 100 ct.	600/cs.
----------	--------	--	---------

D. PLACESETTER® DELUXE FOAM DINNERWARE

PACTIV

Premium quality laminated foam construction. Non-absorbent, cut resistant surface. Excellent for wet foods and knife use.

Vanilla

16200116	TK50004	4 oz./5 oz. Bowl	1000/cs.
16200121	TK50012	12 oz. Bowl	1000/cs.
16200022	TK50030	30 oz. Bowl	500/cs.
16200098	TK50006	6" dia., Plate, Bread & Butter	1000/cs.
16200101	TK50007	7" dia., Plate, Sandwich	1000/cs.
16200102	TK50009	9" dia., Plate	500/cs.
16200106	TK50011	9" dia., 3-Compt. Plate	500/cs.
16200107	TK50010	10 ¹ / ₄ " dia., Dinner Plate	500/cs.
16200113	TK50044	10 ¹ / ₄ " dia., 3-Compt. Plate	500/cs.
16200114	TK50045	7" x 9", Platter	1000/cs.
16202085	TK50043	8 ¹ / ₂ " x 11 ¹ / ₂ ", Platter	500/cs.

White

16200307	TK10004	4 oz./5 oz. Bowl	1000/cs.
16200210	TK10012	12 oz. Bowl	1000/cs.
16200189	TK10006	6" dia., Plate, Bread & Butter	1000/cs.
16200200	TK10007	7" dia., Plate, Sandwich	1000/cs.
16200208	TK10009	9" dia., Plate	500/cs.
16200209	TK10011	9" dia., 3-Compt. Plate	500/cs.
16200211	TK10010	10 ¹ / ₄ " dia., Dinner Plate	500/cs.
16200214	TK10044	10 ¹ / ₄ " dia., 3-Compt. Plate	500/cs.
16200215	TK10045	7" x 9", Platter	1000/cs.
16200212	TK10043	8 ¹ / ₂ " x 11 ¹ / ₂ ", Platter	500/cs.



BOWLS, PLATES & PLATTERS

Laminated Foam Dinnerware

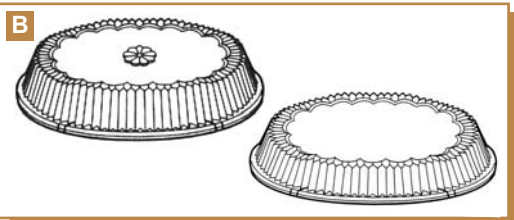
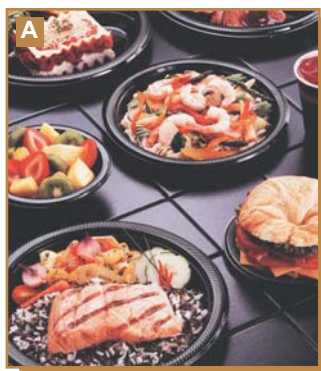

BOWLS, PLATES & PLATTERS

A. PLACESETTER® PREMIER DINNERWARE

PACTIV

Premium quality laminated foam dinnerware. Black.

16202235	TXB0004	4 oz./5 oz., Bowl	1250/cs.
16200862	TXB0012	12 oz., Bowl	1000/cs.
16201570	TXB0030	28 oz., Bowl	500/cs.
16201133	TXB0006	6" dia., Plate	1000/cs.
16200010	TXB0007	7" dia., Plate	1000/cs.
16201649	YTXB00090000	8 ⁷ / ₈ " dia., Plate	500/cs.
16200009	TXB0009	9" dia., Plate	500/cs.
16201132	TXB0010	10 ¹ / ₄ " dia., Plate	500/cs.
16200741	TXB0044	10 ¹ / ₄ " dia., 3-Compt. Plate	500/cs.
16209735	TXB044D	10 ¹ / ₄ " dia., 3-Compt. Deep Plate	500/cs.
16201345	TXB0043	8 ¹ / ₂ " x 11 ¹ / ₂ " Platter	500/cs.
16201335	TXB0047	10" x 12 ¹ / ₂ " Platter	500/cs.

B. PLACESETTER® DOME LIDS

PACTIV

Clear plastic dome lid for Placesetter® foam dinnerware.

16201738	CI80006	Fits 6 oz. Bowl	504/cs.
16200778	CI80009	Fits 9 oz. Bowl	250/cs.
16200546	CI80010	Fits 10 oz. Bowl	250/cs.
16200728	CI80012	Fits 12 oz. Bowl	504/cs.
16202228	CI80012	Fits 12 oz. Bowl	504/cs.
16205910	85910	Fits 8 ¹ / ₂ " x 11 ¹ / ₂ " Platter	250/cs.
16205914	85914	Fits 10" x 12 ¹ / ₂ " Platter	250/cs.

C. CENTER PIECE® FOAM DINNERWARE

SOLO®

Polystyrene laminated foam dinnerware. Topped with a single layer of laminate for cut-resistance, Center Piece is an excellent everyday choice for strength.

Champagne

18702627	RS5DBY0019	5 oz., Bowl	1000/cs.
18705304	RS6BPY0019	6" dia., Plate	1000/cs.
18700631	RS7SPY0019	7" dia., Plate	1000/cs.
18705308	RS9DPY0019	9" dia., Plate	500/cs.
18705326	RS10CY0019	10" dia., 3-Compt. Plate	500/cs.

White

18700350	RS35BY0007	3 ¹ / ₂ oz., Bowl	1000/cs.
18705266	RS12BN0007	12 oz., Bowl	1000/cs.
18705302	RS6BPY0007	6" dia., Plate	1000/cs.
18705629	RS7SPY0007	7" dia., Plate	1000/cs.
18705316	RS9DPY0007	9" dia., Plate	500/cs.
18705328	RS105Y0007	10" dia., Plate	500/cs.

D. CHALLENGE PLUS™ PLATES

SOLO®

Round, double laminated foam construction.

18200724	PA6	6" dia., Almond	1000/cs.
18200720	PH6	6" dia., White	1000/cs.
18209515	CD15C	10" dia., 3-Compt., White	500/cs.

E. ELEGANCE FOAM PLATES

SOLO®

Sleek and black, Elegance provides an efficient alternative to permanentware. Its thick top laminate creates a strong cutting surface and helps support heavier foods like steak or an overstuffed baked potato.

18700176	SR6BP0004	6" dia., Plate, Black	1000/cs.
18700183	SR10C0004	10" dia., 3-Compt. Plate, Black	500/cs.

F. SILENT SERVICE® FOAM BOWLS

SOLO®

Polystyrene heavy laminated foam dinnerware. Provides an efficient alternative to permanentware. Its thick top laminate creates a strong cutting surface and helps support heavier foods like steak or an overstuffed baked potato.

18705612	SS8CDY0019	8 oz., Casserole, Champagne	1000/cs.
18705620	SS30BY0019	30 oz., Bowl, Champagne	500/cs.

Paper Cold Drink Cups



PAPER COLD DRINK CUPS

A. ENVY® PAPER COLD CUPS PRIME SOURCE®

Features a smooth wax finish inside and out for strength, rigidity, and beauty.

75002023	75002023	5 oz.	3000/cs.
75002024	75002024	7 oz.	2000/cs.
75002001	75002001	7 oz.	2500/cs.
75002025	75002025	8 oz.	2000/cs.
75002028	75002028	12 oz.	2000/cs.
75002004	75002004	12 oz.	2500/cs.
75002005	75002005	16 oz.	1000/cs.
75002006	75002006	20 oz.	1000/cs.
75002031	75002031	22 oz.	1000/cs.
75002007	75002007	24 oz.	1000/cs.
75002008	75002008	32 oz.	500/cs.



B. DIXIE® PAPER COLD CUPS GEORGIA PACIFIC FOODSERVICE

Polycoated cups are the preferred type of cup for cold beverage service. Dixie® Sage™ Design for a matched mealservice, beverage and take-out system with a contemporary, coordinated look. Ideal for take-out.

15001600	45SAGE	3 oz., Flush Bottom	2400/cs.
15001710	45SCDX	3 oz., Flush Bottom, Wise Size™	1200/cs.
15001768	58SAGE	5 oz. Waxed, Wise Size™	1200/cs.
15001695	58SAGE	5 oz. Waxed, Wise Size™	2400/cs.
15001577	77SAGE	7 oz.	2400/cs.
15001715	12FPSAGE	12 oz.	2400/cs.
15000053	12FPSCDX	12 oz. Flair, Wise Size™	1200/cs.



C. HARVEST COLLECTION™ COLD DRINK CUP GENPAK

Compostable dinnerware item for foodservice applications. Produced from environmentally friendly, annually renewable resources.

34789234	HCC16	16 oz., Harvest Tan	1000/cs.
----------	-------	---------------------	----------



D. PAPER COLD CUPS SOLO®

Double sided poly cold cups.

18700414	RS22N00055	22 oz., Jazz®	1000/cs.
18700888	44TDN02050	44 oz., White	250/cs.



E. SYMPHONY™ PAPER COLD CUPS SOLO®

Using on-trend colors and a sophisticated pattern. Whether you're looking for cups, dinnerware, or containers, Symphony's coordinating pieces offer the perfect single-use solution to complement every meal and beverage.

Double Sided Poly Cold Cups

18201064	RP16J8000	16 oz.	1000/cs.
18201067	RSP21NJ8000	21 oz.	1000/cs.

Treated Cold Cups

18201076	R53J8000	5 oz.	3000/cs.
18201078	R7NJ8000	7 oz.	2000/cs.
18201079	R8NJ8000	8 oz.	2000/cs.
18201081	R9NJ8000	9 oz.	2000/cs.
18201082	R12NJ8000	12 oz.	2000/cs.
18201086	RW16J8000	16 oz.	1000/cs.



F. JAZZ® PAPER COLD CUPS SOLO®

Waxed cold cups.

18200127	R5300055	5 oz.	3000/cs.
18200150	R6NN00055	6 oz.	2000/cs.
18200191	R7N00055	7 oz.	2000/cs.
18200295	R9N00055	9 oz.	2000/cs.
18705214	R10NN00055	10 oz.	2000/cs.
18200346	R12SN00055	12 oz. Squat	2000/cs.
18200335	R12N00055	12 oz.	2000/cs.
18200355	RW1600055	16 oz.	1000/cs.
18200368	R2000055	20 oz.	1000/cs.
18200386	R2400055	24 oz.	1000/cs.
18200417	H32TN00055	32 oz. Tall	480/cs.



CUPS

Paper Hot Drink Cups

PAPER HOT DRINK CUPS



A. ENVY® PAPER HOT CUPS

PRIME SOURCE®

Poly lined to preserve beverage quality and enhance cup strength.

75002040	75002040	6 oz.	1000/cs.
75002056	75002056	6 oz., Handled	1000/cs.
75002041	75002041	8 oz.	1000/cs.
75002057	75002057	8 oz., Handled	1000/cs.
75002042	75002042	10 oz.	1000/cs.
75002051	75002051	12 oz. Squat	1000/cs.
75002043	75002043	12 oz.	1000/cs.
75002044	75002044	16 oz.	1000/cs.

B. CAFE G™ GOURMET COFFEE CUPS

DART

Cafe G™ stock printed foam cups keep beverages hot while remaining comfortable to the touch. The Cafe G™ coffee-themed design incorporates a subtle color coding system to help customers and employees identify the correct cup size.

12500089	12X16G	12 oz. Squat, Red Accents	1000/cs.
12500090	16X16G	16 oz., Green Accents	1000/cs.
12500091	20X16G	20 oz., Red Accents	500/cs.

C. HOT DRINK CUP

DOPACO

Paper hot cups designed so the same lid fits more cups. Made to reduce your inventory, free up counter space and make life easier for your customers. Available in stock, plain or custom print.

66371701	17001	12 oz. Tall, Swirl Print	1000/cs.
----------	-------	--------------------------	----------

D. DIXIE® PAPER HOT CUPS

GEORGIA PACIFIC FOODSERVICE

Polylined paper hot cups. Designed to heat up your beverage sales. Perfect for samples and espresso drinks. Keeps liquid from soaking through. Provides upscale image at an economical cost for specialty hot beverages.

15001689	2338SAGE	8 oz., Sage™	1000/cs.
15001767	2338SCDX	8 oz., Sage™, Wise Size™	1000/cs.
15001599	4338SAGE	8 oz. w/Handle, Sage™	500/cs.
15004338	4338SAGE	8 oz. w/Handle, Sage™	1000/cs.
15001765	2340SAGE	10 oz., Sage™	1000/cs.
15001766	2342SAGE	12 oz., Sage™, Printed Wrapper	1000/cs.
15002335	2342SAGE	12 oz., Sage™, Plain Wrapper	1000/cs.
15001242	2342W	12 oz., Simply White	1000/cs.

E. INSULAIR® ECOSMART® TRIPLE WALL

INSULATED PAPER CUPS

GEORGIA PACIFIC FOODSERVICE

Insulated paper cup made with post-consumer recycled fiber. Built-in sleeve eliminates the need for a separate cup sleeve. Solid paper construction promotes high-quality image. Keeps drinks hot 15 minutes longer than ordinary paper cups while remaining 20° cooler to the touch. Lids hug cup brim on inside and outside, forming a vacuum.

15000169	AROREF0108C	8 oz., Aroma™, Wise Size™	500/cs.
15008302	NATWHI0108C	8 oz., Natural White	600/cs.
15008350	AROCOF0112C	12 oz., Aroma™	600/cs.
15000172	AROREF0112C	12 oz., Aroma™, Wise Size™	500/cs.
15000173	AROREF0116C	16 oz., Aroma™, Wise Size™	500/cs.

F. PERFECTOUCH® GRAB 'N GO

CUP/LID COMBOS

GEORGIA PACIFIC FOODSERVICE

Cup and lid combo pack. WiseSize™ convenient cash and carry pack. Insulated paper cup eliminates double cupping and the need for expensive beverage sleeves.

15003295	5342DXGNG	12 oz., Coffee Dreams, 14 Sets	140/cs.
15005341	5342DXCOMBO	12 oz., Coffee Dreams, 50 Sets	100/cs.

Paper Hot Drink Cups



A. PERFECTOUCH® INSULATED CUP GEORGIA PACIFIC FOODSERVICE

Insulated paper cup eliminates double cupping and the need for expensive beverage sleeves. Space saving smaller case size replaces traditional sleeves of product. WiseSize™ convenient cash and carry pack.

15005311 5310DX 10 oz., Coffee Dreams 500/cs.



B. PERFECTOUCH® INSULATED CUPS GEORGIA PACIFIC FOODSERVICE

Made from paper. Does not contain polystyrene foam. Insulated with a textured non-slip grip.

15006338 5338CD 8 oz., Coffee Design 1000/cs.

15002959 92959BE 10 oz., Bean Design 1000/cs.

15005343 5342BB 12 oz., Bean Design 1000/cs.

15000575 5342CD 12 oz., Coffee Design 1000/cs.

15000576 5356CD 16 oz., Coffee Design 1000/cs.

15001225 5360CD 20 oz., Coffee Design 500/cs.

Wise Size™ Packed 20/25

15001355 5338DX 8 oz., Coffee Design 500/cs.

15001356 5342DX 12 oz., Coffee Design 500/cs.

15000052 5356DX 16 oz., Coffee Design 500/cs.



C. ECOTAINER® HOT CUPS INTERNATIONAL PAPER

Made with fully renewable resources; fiber from sustainably managed forests and Ingeo™ a plant-based material (PLA). Meets Sustainable Forestry Initiative® (SFI®) Chain-of-Custody certification standards. Meets ASTM Standards for Compostability. Certified by the Biodegradable Products Institute (BPI). Performance is comparable to standard single-use paper disposables. Made in the USA.

14700080 SMRE8 8 oz. 1000/cs.

14703034 SMME10COMPASS 10 oz., Compass 1000/cs.

14700350 SMRE12 12 oz. 1000/cs.

14700351 SMRE16 16 oz. 1000/cs.

14700349 SMRE20 20 oz. 1000/cs.



D. ENVELOP® LABELED HOT CUPS PACTIV

Superior heat retention. Cups are cooler to the touch, yet keep contents hot. Exceptional sidewall strength eliminates the need for cup sleeve/double cupping and ensures optimal sturdiness and durability. Superior graphics print capability. Up to a nine color process which can give you magazine picture quality. One-piece construction improves leak resistance.

16205600 YHCL16ENV 16 oz., Savor™ 420/cs.

16205602 YHCL20ENV 20 oz., Savor™ 480/cs.

16205601 YHCL24ENV 24 oz., Savor™ 360/cs.



E. BARE™ PAPER HOT CUPS SOLO®

First ever FDA compliant PCF paper hot cup. Made from at least 10% post-consumer recycled fiber. Made from at least 90% renewable resources.

18200989 374RCJ8484 4 oz. 1000/cs.

18200991 378RCJ8484 8 oz. 1000/cs.

18200993 410RCJ8484 10 oz. Squat 1000/cs.

18200992 370RCJ8484 10 oz. 1000/cs.

18200994 412RCJ8484 12 oz. 1000/cs.

18200995 316RCJ8484 16 oz. 1000/cs.

18200997 420RCJ8484 20 oz. 600/cs.



F. BARE™ PLA HOT CUPS SOLO®

PLA hot cups are fully compostable, degrading through biological decomposition. Paper cup lined in PLA (a plant-based resin). Made from 100% renewable resources. Compostable in a commercial compost facility.

18202571 378PLAJ7234 8 oz., Bloom 1000/cs.

18202573 412PLAJ7234 12 oz., Bloom 1000/cs.

18202574 316PLAJ7234 16 oz., Bloom 1000/cs.

18202575 420PLAJ7234 20 oz., Bloom 600/cs.



CUPS

Paper Hot Drink Cups/Sleeves/Plastic Cups



CUPS

A. DUO SHIELD™ INSULATED HOT CUP SOLO®

The ultimate solution. No more double-cupping. No more sleeves. Air-pocket insulation for perfect hand-hold temperature. Reduces serving time. Colorful, premium design.
18201298 IC12J7534 12 oz., Tuscan Café 600/cs.

B. HOT DRINK CUP SOLO®

Poly lined paper hot drink cup.
18209420 420MD0062 20 oz., Meridian™ 600/cs.

C. PAPER HOT CUPS SOLO®

Whether you're serving coffee, tea or cocoa, our hot cups are easy to warm up to. They deliver everything you could want in a hot cup: High performance single-poly structure, an upscale appearance and a 5-in-1 lid design.

Bistro™

18200902	374SI0041	4 oz.	1000/cs.
18200897	378SI0041	8 oz.	1000/cs.
18200895	370SI0041	10 oz.	1000/cs.
18200894	412SI0041	12 oz.	1000/cs.
18200893	316SI0041	16 oz.	1000/cs.
18200892	420SI0041	20 oz.	600/cs.

Jazz®

18201401	P50800055	8 oz.	1000/cs.
18702232	HP50800055	8 oz., w/Handle	1000/cs.
18700510	P51000055	10 oz.	1000/cs.
18701125	PS51200055	12 oz. Squat	1000/cs.
18700144	P51200055	12 oz.	1000/cs.
18704612	P51600055	16 oz.	1000/cs.

Mistique®

18206423	378MS0029	8 oz.	1000/cs.
18206422	412MS0029	12 oz.	1000/cs.
18206421	316MS0029	16 oz.	1000/cs.
18206420	420MS0029	20 oz.	600/cs.
18206418	424MS0029	24 oz.	500/cs.

White

18208940	374W2050	4 oz.	1000/cs.
18705041	P50402050	4 oz.	1000/cs.
18700309	P50602050	6 oz.	1000/cs.
18207962	378W2050	8 oz.	1000/cs.
18700291	P50802050	8 oz.	1000/cs.
18207959	378HW2050	8 oz., w/Handle	1000/cs.
18207942	370W2050	10 oz.	1000/cs.
18700299	P51002050	10 oz.	1000/cs.
18705123	PS51202050	12 oz. Squat	1000/cs.
18200204	412W2050	12 oz.	1000/cs.
18700325	P51202050	12 oz.	1000/cs.
18207907	316W2050	16 oz.	1000/cs.
18700147	P51602050	16 oz.	1000/cs.
18204200	420W2050	20 oz.	600/cs.
18706620	P52002050	20 oz.	1000/cs.

HOT CUP SLEEVES

D. CUP BUDDY® INTERNATIONAL PAPER

Fits 10 to 24 oz. cups. Locks in place with heat-activated adhesive. Easy to grip texture. Compostable and recyclable.
14704002 RCDK20 Brown 1200/cs.

PLASTIC CUPS

E. PLASTIC TUMBLER/LID PRIME SOURCE®

Premium clear plastic tumbler.
76008008 76008008 9 oz., Clear 1000/cs.
76008009 76008009 Lid Fits 9 oz. 1000/cs.

Plastic Cups



A. CONEX CLASSIC® COLD CUP DART

Conex Classic® premium plastic cups will enhance your visibility with their crystal clarity and print capability.

12505500 16CT 16 oz., Clear 1000/cs.

B. CONEX® COLD CUPS DART

Translucent plastic cold drink cups with smooth rolled rims. Sidewall rings add strength and provide a no-slip gripping surface.

12505170 12SN 12 oz. 1000/cs.

12505180 14N 14 oz. 1000/cs.

12500014 16K 16 oz. 1000/cs.

C. DIXIE® CLEAR CUPS GEORGIA PACIFIC FOODSERVICE

WiseSize PETE plastic cups.

15002219 CP10DX 10 oz. 500/cs.

15002221 CP12DX 12 oz. 500/cs.

15002222 CP16DX 16 oz. 500/cs.

D. DIXIE® PETE® CLEAR CUPS GEORGIA PACIFIC FOODSERVICE

Shatter resistant, crystal clear cups are strong, durable and highly flexible. Large smooth area for custom printing. Use with Lids CL1420, DL1420, DF1420.

15008877 CP9A 9 oz. Squat 1000/cs.

15002214 CP1214 12/14 oz. 1000/cs.

E. KID'S CUP COMBO HUHTAMAKI

Includes cup, lid, and clear flexible whistle straw. Injection-molded plastic cup.

15306273 06273 12 oz., Yellow Blades & Headphones Design 250/cs.

F. NATURE FRIENDLY® PLA COLD CUPS/LID NATURE FRIENDLY PRODUCTS

Nature Friendly Products' 100% biodegradable and compostable PLA cold cups, lids and straws provide consumers with an eco-friendly alternative to traditional disposables. Made from corn-based PLA renewable resources, these products are completely compostable within 50-100 days in home and commercial composting facilities, and are non-toxic and superior in strength and performance.

C6938003 PLA98540 16 oz. 1000/cs.

C6930003 GC16SR 16/18 oz., Retail Pack 1000/cs.

C6938004 PLA98650 22 oz. 1000/cs.

C6938012 L988K Flat Lid Fits 16/22 oz. Cups 1000/cs.

G. EARTHCHOICE® PLA CUPS/LIDS PACTIV

Made with Ingeo™ - 100% annually renewable material made from plants. Exceptional clarity - makes drink identification easy and presents contents in an upscale way. Exceptional strength - durable, made tough for everyday demand. Custom printing available - communicates brand image. Optimized cube utilization packs - efficient case packs for shipping. Snap lock lids. ASTM D 6400 certified and compostable.

16202475 YPLA9C 9 oz., Clear 975/cs.

16202474 YPLA1412C 12-14 oz., Clear 680/cs.

16202473 YPLA160C 16 oz., Clear 696/cs.

16202472 YPLA21C 20 oz., Clear 600/cs.

16202469 YPLA24C 24 oz., Clear 580/cs.

16202476 YLPADL24C Dome Lid Fits 12, 14, 16, 20, 24 oz. 900/cs.

16202042 YLPLA24C Straw Slot Lid Fits 12, 14, 16, 20, 24 oz. 915/cs.

H. TRANSLUCENT CUPS PACTIV

Economy translucent cups.

16209909 CTN0009 9 oz. 100/25/cs.

16209910 CTN0010 10 oz. 2500/cs.

16209904 CTN0016 16 oz. 20/50/cs.

I. TRANSLUCENT DRINK CUP PACTIV

Extraordinary value - cup has the strength and durability you demand at a price you desire. Efficient design - precision rolled rim offers smooth drinking and a leak resistant seal for the lid. Easy to hold - raised sidewalls offer a "no-slip" grip.

16201569 YE160 16 oz., Natural 960/cs.



CUPS

Plastic Cups



CUPS



A. BARE™ RECYCLED COLD CUPS SOLO®

Bare™ cups are made from 25% post-consumer recycled plastic, helping reduce new materials being created from earth's resources. Strong and clear, Bare™ cups display the same quality consumers have come to expect from Solo's conventional clear cups.

18201013	<i>RTP16J9036</i>	16 oz., Bloom	1000/cs.
18201001	<i>RTN20J9036</i>	20 oz., Bloom	1000/cs.
18200998	<i>RTD24J9036</i>	24 oz., Bloom	600/cs.

B. CLARITY® PLASTIC CUP SOLO®

Clear, durable soft plastic. Strong and shatterproof. Printable.

18701021	<i>CD21N00090</i>	21 oz., Clear	500/cs.
-----------------	-------------------	---------------	---------



C. COLD CUPS SOLO®

Plastic party cold cups.

18201720	<i>P16BRL</i>	16 oz., Blue	1000/cs.
18200873	<i>P16RLR</i>	16 oz., Red	1000/cs.



D. CRYSTAL LINE PLASTIC CUP SOLO®

Treat your customers to the sparkle of fine crystal - without all the trouble. These refined, clear polystyrene cups are sure to impress.

18701608	<i>FC95X00090</i>	9 oz. Squat, Clear	500/cs.
-----------------	-------------------	--------------------	---------



E. DIAMOND® PLASTIC CUP SOLO®

These attractive multi-use, diamond-cut cups add a touch of elegance to any operation. To take their appeal to the next level, they're printable in all sizes and the 10 oz. size is available wrapped.

18705820	<i>TC105X00090</i>	10 oz., Clear	500/cs.
-----------------	--------------------	---------------	---------



F. GALAXY® TRANSLUCENT PLASTIC CUPS SOLO®

For those who want a larger water cup, but prefer plastic, Galaxy® cups are a convenient and economical choice. They feature double sidewall ridges for added strength. Polystyrene.

18202150	<i>Y5JJ</i>	5 oz.	2000/cs.
18202151	<i>Y7JJ</i>	7 oz.	2000/cs.
18202159	<i>Y9JJ0100</i>	9 oz.	1500/cs.
18202153	<i>Y10JJ0100</i>	10 oz.	1500/cs.
18202154	<i>Y12JJ</i>	12 oz.	1000/cs.
18202155	<i>Y14JJ</i>	14 oz.	1000/cs.
18202156	<i>Y16JJ0100</i>	16 oz.	1000/cs.
18200616	<i>Y16RL0100</i>	16 oz., Beer Cup	1000/cs.
18206807	<i>Y16SJ</i>	16-18 oz. Squat	1000/cs.
18202090	<i>Y20JJ</i>	20 oz.	800/cs.



G. GO CUP® SOLO®

Give your customers the convenience of the tapered bottom cup. The tapered bottom means the Go Cup® fits in a standard car cup holder. A tight fit makes a great seal. The lids are tight fitting to prevent spills during carry-out and travel.

18708205	<i>CG44W00007</i>	44 oz., White	240/cs.
-----------------	-------------------	---------------	---------



H. KID'S CUP SOLO®

Combo packed with red lids and flexible straws.

18701473	<i>JH12SL</i>	12-14 oz.	250/cs.
-----------------	---------------	-----------	---------



I. LUMINA® TRANSLUCENT PLASTIC CUPS SOLO®

Economical. Convenient. Sidewall ridges for added strength. Polystyrene construction.

Unwrapped

18701619	<i>CDE500090</i>	5 oz.	2500/cs.
18701622	<i>CDE1000090</i>	10 oz.	2500/cs.
18701623	<i>CDE12T00090</i>	12 oz.	1000/cs.
18700021	<i>CDE1200090</i>	12-14 oz.	1000/cs.
18701618	<i>CDE1600090</i>	16-18 oz.	1000/cs.

Wrapped

18709699	<i>WCDE9</i>	9 oz.	1000/cs.
-----------------	--------------	-------	----------

Plastic Cups



A. SOLO® COZY® WATER CUP & HOLDER SOLO®

Holds plastic water cup liners.

18200806	806A	7 oz. Cup, White	2000/cs.
18208916	68RWA	Holder, Walnut	12/cs.



B. SOLO® PARTY PLASTIC DRINK CUPS SOLO®

Solo® Party Cups are perfect for any occasion. Try the convenient small refill sizes for water cup applications and the larger sizes for sodas, juices and mixed drinks. With multi-layer construction for rigidity, and a wide variety of design and color options, these durable, high-quality disposables are always impressive.

18204610	P35A	3½ oz., Translucent	2500/cs.
18204657	PS12R	12-14 oz., Red	1000/cs.



C. ULTRA CLEAR™ COLD CUPS SOLO®

Solo® Ultra Clear™ cups have superb clarity and crack resistance for a high-end look and feel. Easily recyclable, they also feature excellent taste and odor integrity. When you need to impress, the difference is clear. PET.

18209121	TP7	7 oz.	1000/cs.
18205808	TP90090	9 oz.	1000/cs.
18205812	TP9CT	9 oz. Tall	1000/cs.
18200010	TP100090	10 oz.	1000/cs.
18205820	TP220090	12 oz. Straight Wall	1000/cs.
18205824	TP120090	12-14 oz.	1000/cs.
18205828	TP160090	16 oz.	1000/cs.
18205832	TN20	20 oz.	1000/cs.
18202400	TD24	24 oz.	600/cs.
18203200	TD320090	32 oz.	300/cs.



D. WRAPPED CUP WNA COMET

Individually wrapped plastic drinking cup.

20851104	AP0900W	10 oz.	1000/cs.
----------	---------	--------	----------

E. CLASSIC CRYSTAL™ WINE GLASSES WNA COMET

Elegant fluted design creates the impression and sparkle of fine cut crystal.

12200050	CCW5240	5½ oz., Clear, 1-Piece	240/cs.
12200013	CC8240	8 oz., Clear, 1-Piece	240/cs.



F. COMETWARE STEMWARE™ CHAMPAGNE WNA COMET

Two-piece champagne glass.

12201140	SW4	4 oz., Clear	500/cs.
----------	-----	--------------	---------

G. COMETWARE™ RIGID TUMBLERS WNA COMET

Clear rigid plastic tumblers.

12200075	T8T	8 oz. Tall	500/cs.
12200080	T9S	9 oz. Squat	500/cs.
12200085	T10	10 oz. Tall	500/cs.
12200090	T12	12 oz. Tall	500/cs.
12200100	T16	16 oz. Tall	500/cs.



PLASTIC HOT CUPS

H. PLASTIC MUG SOLO®

No-tip pedestal. Two-finger grip. Uses lid # LH6.

18704326	SS78BK	7 oz., Black	500/cs.
----------	--------	--------------	---------



I. CLASSICWARE® COFFEE MUG WNA COMET

Upscale styling with a unique handle design allows fingers to avoid contact with the hot cup. Tight product nesting creates storage space savings.

12200765	CWM8192	8 oz., Clear	192/cs.
----------	---------	--------------	---------

CUPS

Foam Cups



FOAM CUPS

A. ENVY® FOAM CUPS

PRIME SOURCE®

Beautifully printed, thin-walled, super insulating cups are excellent for hot or cold drinks.

75002802	75002802	12 oz.	1000/cs.
75002804	75002804	16 oz.	750/cs.
75002806	75002806	20 oz.	750/cs.

B. DRINK CUPS

DART

Foam cups keep beverages at their proper serving temperature on the inside and keep hands comfortable on the outside. Hot or cold, insulated foam delivers drinks the way they were meant to be. White.

12501014	4J4	4 oz.	1000/cs.
12500212	6J6	6 oz.	1000/cs.
12500220	8J8	8 oz.	1000/cs.
12500124	10J10	10 oz.	1000/cs.
12501212	12J16	12 oz. Medium	1000/cs.
12500136	12J12	12 oz. Tall	1000/cs.
12500148	14J16	14 oz. Medium	1000/cs.
12501214	14J12	14 oz. Tall	1000/cs.
12500152	16J16	16 oz.	1000/cs.
12500172	20J16	20 oz.	500/cs.
12502416	24J16	24 oz., 20/pk.	500/cs.
12500180	24J24	24 oz., 25/pk.	500/cs.
12500196	32TJ32	32 oz.	500/cs.
12505080	44TJ32	44 oz.	300/cs.

C. HORIZON® DRINK CUPS

DART

The Horizon® design adds a touch of color to any beverage service, while providing an economical alternative to custom print. Suited for hot or cold beverages. Color coded by size in attractive, contemporary colors. Printed with UV inks for brighter colors and sharper print definition. UV inks emit no volatile organic compounds into the environment.

12500023	12J16H	12 oz. Medium, Forest Green	1000/cs.
12500019	12J12H	12 oz. Tall, Forest Green	1000/cs.
12501610	16J16H	16 oz., Cranberry	1000/cs.
12500053	20J16H	20 oz., Blueberry	500/cs.

D. IMPULSE™ DRINK CUPS

DART

Bright and contemporary. High quality and upscale. Coordinated and practical. They feature vivid colors and a modern design that is sure to attract attention.

12500232	12J16E	12 oz. Medium, Teal/Pink/White	1000/cs.
12500001	16J16E	16 oz., Teal/Pink/White	1000/cs.
12500054	20J16E	20 oz., Teal/Pink/White	500/cs.

E. TROPHY® HOT/COLD CUPS

SOLO®

Keeps cold drinks cold and hot drinks hot with insulated thin-wall laminated polystyrene foam. Durable two-layer construction resists crushing from day-to-day handling. Solid, non-permeable sidewall resists seepage. Rolled rim offers upscale, paper-like image. Lugs provide improved stackability and nesting. Foaming materials used have low Global Warming Potential (GWP) and no Ozone-Depleting Potential (ODP). Does not contain BPA. Trophy® uses less material than paper or non-foamed plastic cups (Trophy is 70% air). Eliminates waste of using a cup sleeve or double cupping.

Bistro™

18200880	X120041	12 oz.	1000/cs.
18200881	X16N0041	16 oz.	750/cs.
18200883	X20N0041	20 oz.	750/cs.

Jazz®

18700484	WX964568	9 oz., Wrapped	900/cs.
18700978	X800055	8 oz.	1000/cs.
18707305	X1200055	12 oz.	1000/cs.

Mistigue®

18200862	X20N0029	20 oz.	750/cs.
----------	----------	--------	---------

Symphony™

18201127	X16NJ8002	16 oz.	750/cs.
18201128	X20NJ8002	20 oz.	750/cs.

Foam Cups/Cold Cup Lids



A. HANDI-KUP® UNIVERSAL HOT/COLD BIG DRINK CUPS WINCUP

WinCup smoothwall foam cups can be used for hot beverages and cold drinks. Expandable polystyrene bead construction.

19409008	H8S	8 oz.	1000/cs.
19404610	H10S	10 oz.	1000/cs.
19401221	C12A	12 oz.	1000/cs.
19406182	C1213	13.1 oz.	1000/cs.
19400118	C12APP	13.5 oz., Profit Pals	1000/cs.
19401615	C1618	16 oz.	500/cs.
19400119	C1618PP	16 oz., Profit Pals	500/cs.
19402022	C2022	20 oz.	500/cs.
19400122	C2022PP	22 oz., Profit Pals	500/cs.
19403234	C3234	32 oz.	500/cs.
19400123	C3234PP	32 oz., Profit Pals	500/cs.
19400375	C4244	42 oz.	250/cs.
19400124	C4244PP	44.2 oz., Profit Pals	250/cs.



B. PROFIT PALS® HOT/COLD DRINK CUPS WINCUP

Scannable bar codes for quicker check-out. Color coded sizes.

19400692	32C32PP	32 oz.	300/cs.
19400120	44C32PP	44 oz.	250/cs.
19404431	44C32PP	44 oz.	300/cs.



C. STYROCUP® FOAM CUP WINCUP

Ideal for hot or cold drinks. Ideal for all markets, grocery chains, mass merchandisers, drug chains, discount stores. Easily recognized by retailers and consumers.

19400109	7F	6-8 oz., White, Retail Pack	1000/cs.
----------	----	-----------------------------	----------

D. WINCUP UNIVERSAL HOT/COLD BIG DRINK CUP WINCUP

Expandable polystyrene bead construction.

19400680	32CC32COKE	32 oz., Coca-Cola®	300/cs.
----------	------------	--------------------	---------

E. WINCUP UNIVERSAL HOT/COLD DRINK CUPS WINCUP

WinCup smoothwall foam cups can be used for hot beverages and cold drinks. Expandable polystyrene bead construction.

19400434	4C4	4 oz., White	1000/cs.
19400703	6C6	6 oz., White	1000/cs.
19406511	8C8SPAN	8 oz., Span	1000/cs.
19404228	8C8	8 oz., White	1000/cs.
19404229	8C8W	8 oz., White	1000/cs.
19406513	12C16SPAN	12 oz., Span	1000/cs.
19400444	12C18	12 oz., White	1000/cs.
19400445	14C18	14 oz., White	1000/cs.
19406183	16C16	16 oz., White	500/cs.
19400446	16C18	16 oz., White	500/cs.
19400447	20C18	20 oz., White	500/cs.
19406184	20C16	20.7 oz., White	500/cs.
19404235	24C18	24 oz., White	300/cs.

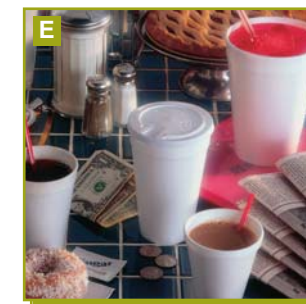

COLD CUP LIDS

F. COLD CUP LIDS DART

Dome Lid w/Hole			
12504931	24LCDH	Fits 16CT, 20CT, 24C, 12P, 16P, 20P, 24P, 16K, 20N, 20K, 24TN, Clear	1000/cs.
Conex® Straw Slotted Lids			
12501023	L24C	Fits 16CT, 20CT, 24C	1000/cs.
High Dome Lid			
50 lids per bag.			
12507222	20HDL C	Fits 20 oz., Clear	1000/cs.

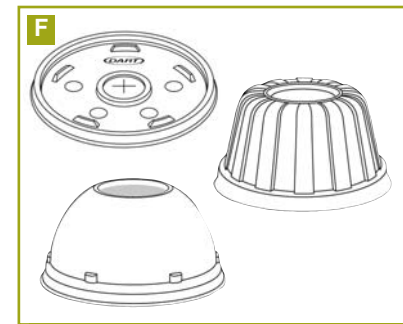

G. COLD CUP LIDS DOPACO

Translucent stock lids.			
66372856	2856	Fits 22 oz.	2400/cs.
66372857	2857	Fits 32 oz.	600/cs.



CUPS

Cold Cup Lids



CUPS



A. COLD CUP LIDS GEORGIA PACIFIC FOODSERVICE

Dixie® PETE® Dome Lid w/Hole

Tight fit plastic dome lid fits multiple sizes. Prevents spillage. Creates a showcase package. Save storage and space.

15009030	DL32	Fits 28, 32 oz.	1000/cs.
15009141	914LSRD	Fits 12, 16, 21 oz.	1200/cs.

B. COLD CUP LIDS SOLO®

Bubble Lid w/Straw Slot

18700644	LX33BN	Fits X33N, Translucent	960/cs.
----------	--------	------------------------	---------

Flat Top Dome Lids

18202004	SDL12	Fits 12 oz., Clear	1000/cs.
18205520	SDL58	Fits TS5, SD5, SD8, Clear	1000/cs.

Identification Straw Slot Lids - Clear

18208838	635NS	Fits 32 oz.	600/cs.
18200362	LC20B10091	Fits CD95, CD12, CD20, CDL95, CDL12, CDL20, CDE12, R20	1000/cs.
18700017	LC211600091	Fits CD16, CD21N, CD24T, CDL16, CDL21, CDL24T, CDE16, CDE21N	1000/cs.

Identification Straw Slot Lids - Translucent

18200297	L9N0100	Fits CD7, CDL7, CDE7, R9N	2000/cs.
18200337	L12BLN0099	Fits CD10, CDE10, CDL101, R12N, RP12N	2000/cs.
18703407	L14BLN00100	Fits CDE12T, CDL12T	2000/cs.
18200388	L1624B0100	Fits R24, RP24, S16	2000/cs.
18200357	L16BL0100	Fits R12SN, RP12S, RP16, RS16N, RW16, RS22N, RSP16N, RSP20, RSP21N, RSP22N	2000/cs.
18200361	L20BL0100	Fits CD12, CD95, CDE12, CDS12, CV18WX, CVP18X, CDL95, CDL12, CD20, CDL20, CDA12, CDA20, R20, VP18, GA20	2000/cs.
18702116	L211600100	Fits CD16, CDE16, CDL16, CDS16, CD21N, CDE21N, CDL21, CDS21N, CD24T, CDL24T, CDS24T, CDA16, CDA24T	1000/cs.
18700338	L28BN0100	Fits CG32C, CG32W, CDL28T, RP28N	960/cs.
18200425	L32BN0100	Fits H32TN, RP32N	960/cs.
18700469	L44BN0100	Fits CG44C, CG44W	960/cs.

Identification Straw Slot Bubble Lid

18200426	LC32B50099	Fits H32TN, RP32N, Clear	500/cs.
----------	------------	--------------------------	---------

Plastic Dome Lids w/Hole - Clear

18201284	DL6260090	Fits TP16, T16IE, TD24, Y16SJ, Y24JJ, PS16, D24	1000/cs.
18201283	DL6620090	Fits TP9, TP12, TN20, PS12	1000/cs.
18209226	DLR160090	Fits R12SN, RN16, RNP16, RNP21, RP12S, RP16, RS16N, RS22, RSP16, RSP21, RSP22, R12S, RSP20, RW16	1000/cs.
18209214	DLR240090	Fits RP24, R24, VS506, VS606	1000/cs.
18209205	DLR6260090	Fits TP16, TD24, TD26, RTP16, RTD26, PX12, PX14, PX16, PX18, PX20, PX24, Y16SJ, Y24JJ, P16RL, D24, DSS5, SD12	1000/cs.
18701349	LD16A00090	Fits CD16, CD21N, CD24T	1000/cs.
18706084	LD28CH0090	Fits CD28T, CDL28T, CDE28T, CG32W, XG32R, RP28N	500/cs.
18200371	LDA20C0090	Fits CD95, CD12, CD20, CDL95, CDL12, CDL20, CDE12, R20	1000/cs.

Plastic Lids w/Straw Slot - Clear

18208896	662TS0090	Fits TP9, TP12, TN20, PS12, TN20	1000/cs.
18200099	600TS0090	Fits TP10, Y9LT, Y10JJ, PS10	2500/cs.
18208848	695TS	Fits Y14JJ	1000/cs.
18208852	626TS0090	Fits TP16, Y16SJ, Y24JJ, PS16, TD24	1000/cs.
18208840	640TS0090	Fits TP22, Y12JJ, M22	2500/cs.
18208888	636TR0001	Fits TD32, Y32JJ, D32	500/cs.

Plastic No Slot Lids

18208860	626TP0090	Fits TP16, TD24, Y16SJ, Y24JJ, PS16, D24	1000/cs.
18208900	662TP0090	Fits TP9, TP12, TN20, PS12, N20	1000/cs.
18203718	M600P0090	Fits 600 TP	1000/cs.

Cold & Hot Cup Lids



A. COLD CUP LIDS (CONT.) SOLO®

Recessed Embossed Straw Slot Lid - Clear		
18200359	L16R0100	Fits R12SN, RP12S, RP16, RS16N, RS22N, RSP16N, RSP20, RSP21N, RSP22N, RW16

Straw Slot Lids - Clear		
18703401	L6NN0100	Fits R6NN
18208872	668TS	Fits 112MD, 168MD, 221MD

Water Cup Lid No Slot		
18208818	605TP	Fits 5 oz., Clear

B. COLD CUP LIDS WINCUP

Handi-Kup® Straw Slot Lids		
19400449	L18S	Fits C12A, C1618, C2022, Translucent
19402033	L32S	Fits C3234, C4244, Simplicity

Straw Slot Lid		
19404242	24LS	Fits 24 oz., Translucent

HOT CUP LIDS

C. HOT CUP LIDS DART

Lift N' Lock™ Lids - 100 Lids/Bag		
12500308	8FTL	Fits 6J8, 8J8, White
12500310	10FTL	Fits 10J10, White
12500312	12FTL	Fits 12 oz., White
12500316	16FTL	Fits 16 Series, White

Lift N' Lock™ Lids w/Straw Slots		
12500311	12FTLS	Fits 12J12, Translucent
12500406	16FTLS	Fits 16 Series, Translucent

Non-Vented Lid - 100 Lids/Bag		
12507012	12CLR	Fits 12 oz., Clear

Non-Vented Dome Lid - 100 Lids/Bag		
12507020	20DLCR	Fits 20 oz., Clear

Optima™ Reclosable Lid		
12507114	16RCLBLK	Fits 16 oz., Black

Plastic Cappuccino Lid - 100 Lids/Bag		
12500161	16EL	Fits 16 oz., White

Sip Thru® Lids - 100 Lids/Bag		
12507108	8UL	Fits 8 oz., White
12500127	10UL	Fits 10 oz., White
12500144	12UL	Fits 12 oz., White
12507116	16UL	Fits 16 oz., White

Straw Slotted Lids - 100 Lids/Bag		
12500128	10SL	Fits 10 oz., Translucent
12500140	12SL	Fits 12 oz., Translucent
12500158	16SL	Fits 16 oz., Translucent
12502412	20SL	Fits 20 oz., Translucent
12500122	24SL05	Fits 24 oz., Translucent
12500192	32SL	Fits 32 oz., Translucent

Vented Lids - 50 Lids/Bag		
12500176	20RL	Fits 20 Series Cups, White
12500194	32RL	Fits 32TJ32, 12B32, White

Vented Lids - 100 Lids/Bag		
12500208	6JL	Fits 6 oz., White
12500216	8JL	Fits 8 oz., White
12500409	10JL	Fits 10 oz., White
12500132	12JL	Fits 12 oz., White

Vented Lids - 100 Lids/Bag		
12505050	4JL	Fits 4J4, Translucent
12507117	16JL	Fits 12J16, 14J16, Translucent
12500170	20JL	Fits 8SJ20, 12SJ20, Translucent
12500184	32JL	Fits 32TJ32, 12B32, Translucent
12500200	48JL	Fits 24MJ48, 32MJ48, Translucent



CUPS

Hot Cup Lids



A. DOME LIDS DOPACO

Hot cup dome lids.

66377674	17674	Fits 10S, 12, 16, 20, Black	1000/cs.
66377699	17699	Fits 10S, 12, 16, 20, White	1000/cs.

B. HOT CUP LIDS GEORGIA PACIFIC FOODSERVICE

Ecosmart® Dome Lids

15000175	PDL8FR1000	Fits 8 oz., White, WiseSize™	1000/cs.
15006696	PDL1216FR100	Fits 12, 16 oz., White, WiseSize™	1000/cs.

Smart Top™ Reclosable Cup Lid

The added security of the patented sliding tab increases the level of functionality compared to most hot cup lids, elevating the to-go experience for consumers by helping to relieve concerns for beverage splash, even in vehicle cup holders.

15009545	TP9542	Fits 12, 16 oz., White	1000/cs.
-----------------	--------	------------------------	----------

Stacking Dome Lids

Condiment identifier easily identifies contents.

15009539	D9538	Fits 8 oz., White	1000/cs.
15008010	D9538	Fits 8 oz., White	1000/cs.
15003540	DL9540	Fits 10 oz., White	1000/cs.
15002544	D9542B	Fits 10-16 & 12-20 oz., Black	1000/cs.
15002542	D9542	Fits 10-16 & 12-20 oz., White	1000/cs.
15009050	D9550	Fits 20, 24 oz., White	1000/cs.

C. WHITE TRAVELER LIDS INTERNATIONAL PAPER

Domed sipper lids.

14700227	LHRDS8	Fits 8 oz.	1000/cs.
14700300	LHRDS16	Fits 12, 16, 20, 24 oz.	1200/cs.

D. HOT CUP LIDS SOLO®

Gourmet Dome Lid

18700400	LTG51600007	Fits 12, 16, 20, 24 oz., White	1000/cs.
-----------------	-------------	--------------------------------	----------

Gourmet Dome Sip Thru Lids

Lids for paper and Trophy® hot cups.

18708080	LGX12R	Fits X12, X16N, X20N, X22N, White	1000/cs.
18701437	LRG516	Fits P516, HP516, Black	1000/cs.
18700421	LTG508	Fits HP508, P508, White	1000/cs.
18200709	LTG512	Fits P512, White	1000/cs.

Liftback & Lock Travel Lid

Lids for paper and Trophy® hot cups. Fits snug. Allows stacking. Tab re-seals, prevents splashes.

18701511	DTLX8	Fits X8, X9, WX9, White	2000/cs.
-----------------	-------	-------------------------	----------

Liftback & Lock Tab Travel Lids - White

18708232	DLX10R00007	Fits X8, X8K, X9, X10N, WX9	2000/cs.
18708230	DLX12R00007	Fits X12, X12K, X16N, X20N, X22N	2000/cs.

Liftback & Lock w/Straw Slot Lid - Translucent

18701234	LX2SBR00100	Fits X12, X16N, X20N, X22N, XN246	2000/cs.
-----------------	-------------	-----------------------------------	----------

Plastic Tear Tab Lids - White

18203104	CL308	Fits 378	1000/cs.
18203102	CL310	Fits 370	1000/cs.
18201855	CL316	Fits 316, 410, 412, 420, 424	1000/cs.

Traveler® Lids

Solo® Traveler® lids solve the commuter's problem. No stubborn tabs to tear or puncture, no squirts or spills. Fits paper hot cups.

18206011	TL38R10007	Fits 8 oz., White	1000/cs.
18206013	TL31R20007	Fits 10 oz., White	1000/cs.
18206005	TLP3160007	Fits 12, 16, 20 oz., White	1000/cs.
18206006	TLB3160004	Fits 12, 16, 20, 24 oz., Black	1000/cs.

Traveler Plus® Lid - White

Reclosable lid prevents spillage and provides safe travel.

18200309	TPLUS0001	Fits 10 oz. Squat, 12, 16, 20, 24 oz.	1000/cs.
-----------------	-----------	---------------------------------------	----------

Trophy Gourmet Dome Lids

18700160	LGX8R0007	Fits 8 oz., White	1000/cs.
18201324	LGXBK20004	Fits 12, 16, 20, 24 oz., Black	1500/cs.
18201328	LGXW20007	Fits 12, 16, 20, 24 oz., White	1500/cs.



Hot Cup Lids/Cone & Water Cups



A. HOT CUP LIDS

WINCUP

Handi-Kup® Drink-Thru Lids

Drink-thru, tear tab, lock back lid.

19400800	DT8	Fits H8S, White	1000/cs.
19400310	DT10	Fits H10S, White, w/Straw Slot	1000/cs.
19400317	DT18B	Fits C12A, White	1000/cs.
19400313	DT12	Fits C1213, C1416, White	1000/cs.

Handi-Kup® Sip Thru Lid

19400705	DL18	Fits 12-24 oz., White	1000/cs.
----------	------	-----------------------	----------

Handi-Kup® Vented Lids - Translucent

19401050	FL	Fits 6-8B, 8FC, 8-10B, 12FC, 16FC	500/cs.
19400333	FL32V	Fits C3234, C4244, F16HVV, F32, B12	500/cs.
19402685	FL4V	Fits 4 oz.	1000/cs.

Handi-Kup® Vented Lid

19400712	L8V	Fits H8S, White	1000/cs.
----------	-----	-----------------	----------

Vented Polystyrene Lids

19400641	FL6V	Fits C1213, F6, F8M, Translucent	1000/cs.
19400308	FL8V	Fits 6GEF9, 6GEG0, 6GEG1, 6GEG2, Translucent	1000/cs.
19400711	L6V	Fits 6 oz., White	1000/cs.



CONE & WATER CUPS

B. CONE WATER CUPS

GENPAK

Tightly rolled edges to increase cup rigidity.

34780449	4F	4 oz., White	5000/cs.
34780042	42F	4½ oz., White	5000/cs.

C. CONE SODA CUP

SOLO®

High quality, leak-proof paper soda cups in a cone shape. Ideal for both water dispensers as well as snow cones.

18208801	6R	6 oz., White	5000/cs.
----------	----	--------------	----------

D. CONICAL CUP

SOLO®

Tough, one-piece, single-wrap, no-leak construction.

18700343	10BFT	10 oz., White	1000/cs.
----------	-------	---------------	----------

E. ECO-FORWARD™ TREATED PAPER CONE CUPS

SOLO®

Treated paper cup. Made from at least 80-90% renewable resources. Compostable in a commercial compost facility. White.

18208201	4R2050	4 oz., Chipboard Box Inner Packaging	5000/cs.
18208203	4BR2050	4 oz., Plastic Sleeve Inner Packaging	5000/cs.
18208215	42R2050	4¼ oz., Chipboard Box Inner Packaging	5000/cs.
18208800	6RB2050	6 oz., Plastic Sleeve Inner Packaging	5000/cs.
18200080	8RB2050	8 oz., Plastic Sleeve Inner Packaging	2500/cs.

F. PAPER FUNNEL CUP

SOLO®

Economical funnel cups are constructed of specially-treated paper with fully rolled rims.

Plastic sleeve inner-pack.

18207325	10BFC	10 oz., Check Your Oil	1000/cs.
----------	-------	------------------------	----------

G. WATER CUP

SOLO®

Cone shaped paper water cup with a rolled rim. Plastic sleeve inner-pack.

18208206	42BR	4¼ oz.	5000/cs.
----------	------	--------	----------

H. FLAT BOTTOM PAPER WATER CUP

SOLO®

Another reliable option. Made with treated paper, these cups provide excellent value. Plastic sleeve inner-pack.

18208230	4042050	4 oz., White	5000/cs.
----------	---------	--------------	----------



CUPS

Cone & Water Cups/Souffle Cups & Lids



CUPS



A. ECO-FORWARD™ WHITE TREATED PAPER COLD CUP SOLO®

Compostable alternative to standard double-sided poly and plastic cold cups. Solo treated paper cold cups do not contribute to landfill volume when composted in a commercial composting facility. Made with at least 50% renewable resources. Match any décor. Wax coating creates firm, durable cup walls for your cold beverages. Secure lid seal resists leaks. Single-lid solution fits multiple cups.

18208225 442050 3 oz., White, Two-Piece 5000/cs.

PAPER SOUFFLÉ CUPS



B. PLEATED PORTION CUPS GENPAK

Convex base keeps portion cups in upright position. Box pleats provide an attractive presentation. White.

34785075 F075 3/4 oz. 5000/cs.
 34785100 F100 1 oz. 5000/cs.
 34785200 F200 2 oz. 5000/cs.
 34785400 F400 4 oz. 5000/cs.



C. TREATED PAPER SOUFFLÉ PORTION CUPS SOLO®

While these souffle portion cups work well for your customers, they are also an economical solution in the back-of-the-house. Chefs like to use these versatile cups as measuring tools. White.

18202610 0502050 1/2 oz. 5000/cs.
 18202613 075S2050 3/4 oz. Squat 5000/cs.
 18202612 0752050 3/4 oz. 5000/cs.
 18202614 1002050 1 oz. 5000/cs.
 18202617 1252050 1 1/4 oz. 5000/cs.
 18202706 2002050 2 oz. 5000/cs.
 18202619 3252050 3 1/4 oz. 5000/cs.
 18202622 4002050 4 oz. 5000/cs.
 18202625 5502050 5 1/2 oz. 5000/cs.



D. MEDICAL & DENTAL CUP SOLO®

Top-notch paper cups for medical testing, inpatient room care, dispensing medications and serving outpatients. Treated paper.

18208220 4502050 3 1/2 oz., White, Pleated Cup 5000/cs.

PLASTIC SOUFFLÉ CUPS & LIDS



E. LIDDLES™ SOUFFLÉ CUPS GEORGIA PACIFIC FOODSERVICE

Attached hinged lids mean no more searching for coordinating lids. Perfect for your signature sauces and dips. Unique 6-pack design. Fill, snap closed, then stack.

15002962 92954 4 oz., Translucent Cup/Clear Lid 900/cs.

F. SOUFFLÉ PORTION CUPS/LIDS GEORGIA PACIFIC FOODSERVICE

Exceptional strength and versatility. Ideal for condiments, sauces, and side portions.

Pre-portioning with souffle cups help control costs and saves time and labor.

Cups

15000141 P010BB 1 oz., Translucent 4800/cs.
 15009915 P015 1 1/2 oz., Translucent 2400/cs.
 15000190 P020BLK 2 oz., Matte Black 2400/cs.
 15000046 P020 2 oz., Translucent 2400/cs.
 15000191 P032BLK 3 1/4 oz., Matte Black 2400/cs.
 15003200 P032 3 1/4 oz., Translucent 2400/cs.
 15000136 P040BLK 4 oz., Matte Black 2400/cs.
 15000134 P040 4 oz., Translucent 2400/cs.
 15009555 P055 5 1/2 oz., Translucent 2400/cs.

Lids

15004001 PL1C Fits 3/4 - 1 1/4 oz., Clear 4800/cs.
 15000170 PL2C Fits 1 1/2 - 2 1/2 oz., Clear 2400/cs.
 15000132 PL2 Fits 1 1/2 - 2 1/2 oz., Translucent 2400/cs.
 15000171 PL4C Fits 3 1/4 - 4 oz., Clear 2400/cs.
 15000133 PL4 Fits 3 1/4 - 4 oz., Translucent 2400/cs.



Plastic Souffle Cups & Lids



A. NATURE FRIENDLY®

PLA PORTION CUPS/LIDS

NATURE FRIENDLY PRODUCTS

Nature Friendly Products' 100% biodegradable and compostable PLA cold cups, lids and straws provide consumers with an eco-friendly alternative to traditional disposables. Made from corn-based PLA renewable resources, these products are completely compostable within 50-100 days in home and commercial composting facilities, and are non-toxic and superior in strength and performance.

C6938070	AP6260	2 oz.	2500/cs.
C6938071	AP78105	3 1/2 oz.	2500/cs.
C6938072	AP78130	4 1/2 oz.	2500/cs.
C6938075	L628K	Lid Fits 2 oz.	2500/cs.
C6938076	L789K	Lid Fits 3 1/2, 4 1/2 oz.	2500/cs.



B. ELLIPSO™ OVAL PORTION CUPS/COMBOS

NEWSPRING

Ellipso breaks away from conventional round portion cups with a wide oval opening. Its elegant design lets you enhance the presentation of your prized sauces. Ellipso offers exceptional benefits: microwaveable, stackable, reusable, economical, refrigerator-friendly.

19510503	E501	1 oz., Clear, Base/Lid Combo	500/cs.
19519001	E1002B	2 oz., Black, Base	1000/cs.
19510502	E502B	2 oz., Black, Base/Lid Combo	500/cs.
19510500	E502	2 oz., Clear, Base/Lid Combo	500/cs.
19519011	E1003B	3 oz., Black, Base	1000/cs.
19510511	E503B	3 oz., Black, Base/Lid Combo	500/cs.
19510510	E503	3 oz., Clear, Base/Lid Combo	500/cs.
19510505	E504	4 oz., Clear, Base/Lid Combo	500/cs.
19510520	E505B	5 oz., Black, Base/Lid Combo	500/cs.
19510526	E506	6 oz., Clear, Base/Lid Combo	500/cs.



C. EARTHCHOICE® PLA PORTION CUPS

PACTIV

Made from a natural plastic material called Ingeo™, an ingenious new material made from plants instead of oil. This means that Ingeo™ is 100% annually renewable, and EarthChoice™ cups and lids are fully compostable in municipal and industrial facilities. Exceptional clarity makes drink identification easy and presents contents in an upscale way. Exceptional strength, durable, made tough for everyday demand. Custom printing available to communicate brand image.

16202561	YSPLA200EC	2 oz.	2400/cs.
16202562	YSPLA300EC	3 1/4 oz.	2400/cs.
16202565	YSPLA400EC	4 oz.	2400/cs.



D. SOUFLÉ CUPS/LIDS

PACTIV

Clear snap fit lids remain securely closed even when stacked.

Clear Cups

16207590	CTSB100	1 oz.	5000/cs.
16207588	CTSB200PP00	2 oz.	2500/cs.
16207592	CTSB325	3 1/4 oz.	2500/cs.
16207595	CTSB400PP00	4 oz.	2500/cs.

Translucent Cups

Crack-resistant resin.

16200678	PCTSB100	1 oz.	5000/cs.
16202420	JCTSB2000000	2 oz.	2500/cs.
16200661	PCTSB325	3 1/4 oz.	2500/cs.
16202421	JCTSB4000000	4 oz.	2500/cs.
16205000	PCTSB550	5 1/2 oz.	2500/cs.

Lids

16201962	PLSL1	Fits 1 oz., Clear	2500/cs.
16201963	PLSL2	Fits 2 oz., Clear	2500/cs.
16202448	LSL3	Fits 3 oz. - 4 oz., Clear	2500/cs.
16202449	LSL5	Fits 5 1/2 oz., Clear	2500/cs.



Plastic Soufflé Cups & Lids/Cup Dispensers

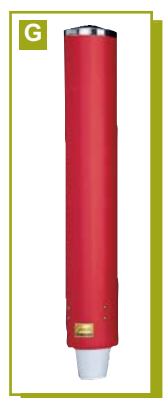

A. PLASTIC SOUFFLÉ PORTION CUPS/LIDS

SOLO®

Several color options to allow you to match any décor or occasion. And to cater to your many needs, you can choose from a wide variety of sizes. All provide an excellent lid fit.

Cups

18204708	P050S0100	1/2 oz. Squat, Translucent	5000/cs.
18204711	P075S0100	3/4 oz. Squat, Translucent	5000/cs.
18204720	P0750100	3/4 oz., Translucent	5000/cs.
18200140	P1000100	1 oz., Translucent	5000/cs.
18204726	P1250100	1 1/4 oz., Translucent	5000/cs.
18204729	P1500100	1 1/2 oz., Translucent	5000/cs.
18200930	B200E0001	2 oz., Black	2500/cs.
18202606	B200N0100	2 oz., Translucent	2500/cs.
18200929	B2000100	2 oz., Translucent	2500/cs.
18204735	P2500100	2 1/2 oz., Translucent	5000/cs.
18200874	P325E0001	3 1/4 oz., Black	2500/cs.
18200325	P3250100	3 1/4 oz., Translucent	2500/cs.
18200872	P400E0001	4 oz., Black	2500/cs.
18204741	P4000100	4 oz., Translucent	2500/cs.
18703653	UR550100	5 1/2 oz., Translucent	2500/cs.

Clear Lids

18204714	PL10090	Fits P050S, P075S, P100, P125, T125, P101, P150	5000/cs.
18204600	PL20090	Fits P150, P200, P200R, P35A, P250, B200, B200R, TH200, TH250, TP35, 405PR	2500/cs.
18200041	PL40090	Fits P325W, P400, T325, T400, P325	2500/cs.

B. SOUFFLÉ CUPS/LIDS

TRELLIS EARTH™

Perfect for showing you care about saving the environment across your entire food line.

C4780044	WFR05	2 oz.	2500/cs.
C4780041	WFR07	4 oz.	2500/cs.
C4780037	WFR06	Lid Fits 2 oz.	2500/cs.
C4780039	WFR08	Lid Fits 4 oz.	2500/cs.

CUP DISPENSERS

C. CUP DISPENSER

GEORGIA PACIFIC FOODSERVICE

Wall mount pull type cold cup dispenser.

15000100	DS1	For 9 oz. Cups, 6 & 8 oz. Hot Cups	1/ea.
----------	-----	------------------------------------	-------

D. EZ-FIT® CUP DISPENSER

SAN JAMAR

The One Size Fits All EZ-Fit® gasket design works with paper, plastic and foam beverage cups. Smooth and controlled dispensing of cups. Includes four pre-cut gaskets to accommodate 8 to 46 oz. beverage cups with rim diameters ranging from 2 7/8" to 4 3/4". Can be mounted vertically or horizontally to work most efficiently with your application.

62572410	C2410C	23 1/4"L, 2 7/8" - 4 3/4" Rim dia.	1/ea.
----------	--------	------------------------------------	-------

E. PULL-TYPE CUP DISPENSERS

SAN JAMAR

Pull-type beverage cup dispensers combine stainless steel quality with universal dispensing of any type of disposable cup. The patented adjustable dispensing collar adjusts to any cup size or material. Included brackets allow for either wall or dispenser stand mounting. Dispenser is top-loaded and gravity fed.

62572900	C3200P	6 to 10 oz. Cups, 2 7/32" - 3 7/16" Rim dia.	1/ea.
62572904	C3400P	12 to 24 oz. Cups, 2 7/4" - 3 7/8" Rim dia.	6/cs.
62572908	C3500P	32 to 46 oz. Cups, 4" - 4 7/8" Rim dia.	1/ea.

F. PULL-TYPE FOAM CUP DISPENSERS

SAN JAMAR

Self-adjusting unbreakable polyethylene dispenser eliminates foam cup damage. Stand or wall mount. Top-loading gravity fed. 23 1/2"L.

62570059	C4410PFSD	12 to 24 oz. Cups, 3 1/4" - 3 7/8" Rim dia.	1/ea.
62570012	C4210PFSD	32 to 46 oz. Cups, 2 3/4" - 3 3/8" Rim dia.	6/cs.

G. PULL-TYPE PAPER CUP DISPENSERS

SAN JAMAR

Pull-type paper cup dispenser. Self-adjusting plastic for simple economic dispensing of paper cups. Top-loading, gravity fed. Constructed of unbreakable polyethylene. 23 1/2"L.

62570210	C4210PRD	4 to 10 oz. Cups, 2 1/2" - 3 1/4" Rim dia.	1/ea.
62574410	C4410PRD	12 to 24 oz. Cups, 3 3/8" - 3 7/8" Rim dia.	1/ea.

CUPS

Wooden Picks & Skewers/Stirrers/Bar Sips



WOODEN PICKS & SKEWERS

A. CORN DOG STICKS

PRIME SOURCE®

High-quality wood. For use in a wide variety of applications such as cooking, cleaning, and personal hygiene.

75002200 75002200 Natural White, Bulk Pack 10,000/cs.

B. FRILL PICKS

PRIME SOURCE®

High-quality wood frill picks.

75002176 75002176 2½", Sandwich Pick, 750 ct. 36,000/cs.
 75002180 75002180 3", Regular, 1000 ct. 10,000/cs.
 750021815 75002181 4", Club, 1000 ct. 1000/cs.
 75002181 75002181 4", Club, 1000 ct. 10,000/cs.

C. SKEWERS

PRIME SOURCE®

High-quality wood. For use in a wide variety of applications.

75002195 75002195 4½", 1000 ct. 10,000/cs.
 75002196 75002196 5½", 1000 ct. 10,000/cs.
 75002199 75002199 7", 1000 ct. 10,000/cs.
 750021985 75002198 10", 1000 ct. 1000/bx.
 75002198 75002198 10", 1000 ct. 3000/cs.

D. TOOTHPICKS

PRIME SOURCE®

High-quality wood. For use in a wide variety of applications.

75002183 75002183 Sandwich Picks, 750 ct. 36,000/cs.
 75002184 75002184 Sandwich Picks, 750 ct. Retail Pack 2/24/750/cs.
 75002185 75002185 Individually Cello Wrapped, 1000 ct. 15,000/cs.
 75002188 75002188 Individually Paper Wrapped Mint, 500 ct. 6000/cs.
 75002186 75002186 Individually Cello Wrapped Mint, 1000 ct. 15,000/cs.
 75002166 75002166 Individually Wrapped Mint, 1000 ct. 15,000/cs.
 750021905 75002190 Round, 800 ct. 19,200/bx.
 75002190 75002190 Round, 800 ct. 96,000/cs.

E. SQUARE EDGE STICKS

PRIME SOURCE®

Birch wood sticks. Square edge.

75002208 75002208 10" x 2mm 10,000/cs.

COFFEE STIRRERS

F. COFFEE STIRRERS

PRIME SOURCE®

High-quality wood. For use in a wide variety of applications.

75002193 75002193 5½", Round End, 1000 ct. 10,000/cs.
 75002194 75002194 5½", Square End, 1000 ct. 10,000/cs.
 75002203 75002203 7" x 1/4", 1000 ct. 10,000/cs.

BAR SIP STICKS & STIRRERS

G. BAR-PAK™ STIRRERS

CELL-O-CORE

Made with virgin resins; no inconsistent regrinds. Non-toxic pigments. Accurate counts.

68174702 EC5RED10PK 5", Red 10,000/cs.
 68170203 BS5BK 5¼", Black 10,000/cs.
 68170190 BS5RD 5¼", Red 10,000/cs.
 68174700 BS5RW 5¼", Red/White Stripe 1000/cs.
 68170204 BS5WR 5¼", White/Red Stripe 10,000/cs.
 68170055 BS55WR 5½", White/Red Stripe 10,000/cs.
 68170040 BS55WR 5½", White/Red Stripe 10,000/cs.
 68170206 BS725WR 7¼", White/Red Stripe 10,000/cs.

H. COFFEE STRAWS/STIRS

SOLO®

For convenience stores or food service.

18209421 89720 7", Brown w/White Stripe 10,000/cs.

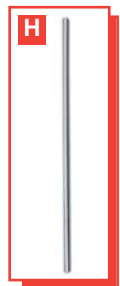

RESTAURANT & BAR SUPPLIES



Straws

STRAWS



RESTAURANT & BAR SUPPLIES

A. STRAWS PRIME SOURCE®

Our straws are of the highest quality and are the most durable. You'll never find a split end with any of our straws. Our neon colors are unique and a definite attention getter.

Collins Straw			
76009772	76009772	8", White/Red	5000/cs.
Collins Straw/Stirs			
75002365	75002365	8", Red, Unwrapped	5000/cs.
Fat Straws - Unwrapped			
75002369	75002369	6", Assorted Neon	3000/cs.
75002371	75002371	6", Black	3000/cs.
75002373	75002373	6", Neon Orange	3000/cs.
75002370	75002370	6", Red	3000/cs.
75002372	75002372	6", Yellow	3000/cs.
75002375	75002375	8", Assorted Neon	2400/cs.
75002379	75002379	8", Black	2400/cs.
75002381	75002381	8", Green	2400/cs.
75002376	75002376	8", Neon Orange	2400/cs.
75002377	75002377	8", Neon Pink	2400/cs.
75002382	75002382	8", Red	2400/cs.
75002378	75002378	8", Yellow	2400/cs.
Frappe Straws			
75002340	75002340	4", Red	5000/cs.
Giant Straws - Unwrapped			
Approx. 0.3" dia.			
75002407	75002407	7 ³ / ₄ ", Black	1500/cs.
75002413	75002413	8", Assorted Color	3200/cs.
75002414	75002414	8", Black	3200/cs.
Giant Straws- Wrapped			
76009770	76009770	7 ³ / ₄ ", White/Red	7200/cs.
Hi-Valu Jumbo Straws			
73007500	73007500	7 ³ / ₄ ", Clear, Wrapped	9600/cs.
Jumbo Straws - Unwrapped			
Approx. 0.22" dia.			
75002384	75002384	6", Red	2500/cs.
75002425	75002425	6", Red	3000/cs.
75002387	75002387	7 ³ / ₄ ", Black	2500/cs.
75002388	75002388	7 ³ / ₄ ", Clear	2500/cs.
76009733	76009733	7 ³ / ₄ ", Clear	12,500/cs.
75002389	75002389	7 ³ / ₄ ", Red	2500/cs.
75002393	75002393	7 ³ / ₄ ", Translucent	2500/cs.
75002391	75002391	8", Black	4500/cs.
Jumbo Straws - Wrapped			
76009741	76009741	7 ³ / ₄ ", Clear	2000/cs.
76009731	76009731	7 ³ / ₄ ", Clear, Boxed	12,000/cs.
76009703	76009703	7 ³ / ₄ ", Clear	12,000/cs.
75002394	75002394	7 ³ / ₄ ", Clear, Bulk	12,000/cs.
76009704	76009704	7 ³ / ₄ ", White	10,000/cs.
76009700	76009700	7 ³ / ₄ ", White/Red	12,000/cs.
76009743	76009743	7 ³ / ₄ ", White/Red	12,500/cs.
76009702	76009702	10 ¹ / ₄ ", Clear	2000/cs.
Milk Straws			
76009757	76009757	5 ³ / ₄ ", White, Wrapped	12,000/cs.
Slim Straws - Unwrapped			
75002361	75002361	8", Assorted Neon	5000/cs.
75002360	75002360	8", Black	5000/cs.
Stir Sticks			
76009717	76009717	5 ³ / ₄ ", White/Red Stripe	10,000/cs.
Super Jumbo Straws			
75002402	75002402	10 ¹ / ₄ ", Black	1500/cs.
Zombie Straws			
75002420	75002420	10 ¹ / ₂ ", Red	450/cs.

Straws



A. STRAWS CELL-O-CORE

Made with virgin resins; no inconsistent regrinds. Non-toxic pigments. Accurate counts.

Bar-Pak™ Collins Straw/Stirs

68170210	BS808	8", Assorted Neon, Unwrapped	5000/cs.
68170209	BS808BLK	8", Black, Unwrapped	5000/cs.
68170208	BS8RD	8", Red, Unwrapped	5000/cs.

Bar-Pak™ Fat Straws

68170212	6BPNA6500	6", Assorted Neon, Unwrapped	3000/cs.
68170217	6BPBK6500	6", Black, Unwrapped	3000/cs.
68170218	8BPNA6400	8", Assorted Neon, Unwrapped	2400/cs.

Bar-Pak™ Giant Straws - Wrapped

68174301	GW24300RD	7 ³ / ₄ ", Red	7200/cs.
68174303	GW24300WR	7 ³ / ₄ ", White/Red Stripe	7200/cs.
68174591	TGW124300RD	12", Red	1200/cs.

Flexible Straws

68170500	FW825400	7 ³ / ₄ ", White, Wrapped	10,000/cs.
----------	----------	---	------------

Jumbo Straws - Unwrapped

68170167	BS515BK	5 ³ / ₄ ", Black	2500/cs.
68170171	BS502BK	5 ³ / ₄ ", Black	12,500/cs.
68170169	BS515CL	5 ³ / ₄ ", Clear	2500/cs.
68170192	BS510BK	7 ³ / ₄ ", Black	1500/cs.
68170197	BS510BK	7 ³ / ₄ ", Black	2500/cs.
68170236	JU50250	7 ³ / ₄ ", Black	12,500/cs.
68170194	BS510CL	7 ³ / ₄ ", Clear	2500/cs.
68170231	JU50250	7 ³ / ₄ ", Translucent	12,500/cs.

Jumbo Straws - Wrapped

68170051	JW24500G	7 ³ / ₄ ", Green	2000/cs.
68174500	JW24T	7 ³ / ₄ ", Translucent	12000/cs.
68174485	JW24WR	7 ³ / ₄ ", White/Red Stripe	2000/cs.
68174580	TGW4300RD	10 ¹ / ₄ ", Red	1200/cs.
68174506	TJW4500RD	10 ¹ / ₄ ", Red	2000/cs.
68174504	TJW4500WR	10 ¹ / ₄ ", White/Red Stripe	2000/cs.
68170007	TJW4500	10 ¹ / ₄ ", Translucent	2000/cs.

Scoop Spoon/Straws

68170781	SS8RD	8", Red, Jumbo, Unwrapped	5000/cs.
----------	-------	---------------------------	----------

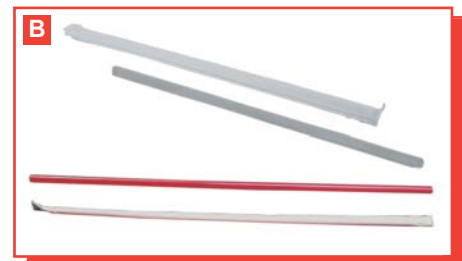

B. STRAWS GEORGIA PACIFIC FOODSERVICE

Giant Straws - Wrapped

Approx. 0.3" dia.

15007757	GW7	7 ³ / ₄ ", Red, Wrapped	7200/cs.
----------	-----	---	----------

Jumbo Straws - Wrapped

0.22" dia.

15000444	JW74	7 ³ / ₄ ", Translucent	2000/cs.
15007775	JW7	7 ³ / ₄ ", Translucent	12000/cs.
15000452	JW12	12", Red	2000/cs.

Stir Straws - Unwrapped

15000105	HS551	5 ¹ / ₂ ", White/Red Stripe	10,000/cs.
15000182	HS551	5 ¹ / ₂ ", White/Red Stripe	10,000/cs.

C. NATURE FRIENDLY® STRAWS NATURE FRIENDLY PRODUCTS

Nature Friendly Products' 100% biodegradable and compostable tableware provides consumers with an eco-friendly alternative to traditional disposables. Made from sugar cane bagasse-based renewable resources, they are completely compostable within 50-100 days in home and commercial composting facilities. These products are superior in strength and performance. Non-toxic, hot/cold tolerant, oil and water resistant, microwave and freezer safe.

C6935078	ST775N4500W	7 ¹ / ₄ ", Giant, Wrapped	2000/cs.
C6935077	ST1025G12300W	10 ¹ / ₄ ", Jumbo, Wrapped	1200/cs.

Straws/Doilies



RESTAURANT & BAR SUPPLIES



A



B



C



D



E



F

A. STRAWS SOLO®

For convenience stores or food service.

Cocktail Straws

182094105 88520 5 1/2", Stripe 1000/bx.

18209410 88520 5 1/2", Stripe 10,000/cs.

Flexible Straws - Wrapped

18203915 13915 7 5/8", Clear 10,000/cs.

Giant Straws - Wrapped

18204332 834TX2050 10 1/4", Translucent 1200/cs.

Giant Wow Straws - Wrapped

18202420 15820 7 3/4", Stripe 7200/cs.

Jumbo Straws - Wrapped

18202830 12830 7 3/4", Clear 12,000/cs.

18709401 822RC 7 3/4", Red Stripe, Convenience Pak 12000/cs.

18700163 832TH 10", Translucent, Half Pak 6000/cs.

Regular Straws - Wrapped

For convenience stores or food service.

18201808 11610 5 3/4", White, Slim Milk Straws 12,000/cs.

Slim Soda Straws - Unwrapped

18201788 818700075 7 3/4", Red w/White Stripe, Polypropylene 5000/cs.

Super Jumbo Straws - Unwrapped

18207915 32820 7 3/4", Stripe 12,500/cs.

Super Jumbo Straws - Wrapped

18202820 12820 7 3/4", Stripe 12,000/cs.

DOILIES

B. CAMBRIDGE LACE DOILIES HOFFMASTER

Doilies convey a quality image, allowing you to more effectively merchandise appetizers, desserts and menu specialties. White.

17800145 500233 4" dia. 1000/cs.

17800142 500234 5" dia. 1000/cs.

17800132 500235 6" dia. 1000/cs.

17800131 500236 8" dia. 1000/cs.

17800137 500238 10" dia. 1000/cs.

17800146 500239 12" dia. 1000/cs.

C. KENMORE ROUND CAKE LACES HOFFMASTER

Doilies convey a quality image, allowing you to more effectively merchandise appetizers, desserts and menu specialties. The small count cases make doilies an affordable elegance for your establishment. White.

17805010 500260 16" dia. 500/cs.

D. FRENCH LACE DOILIES SMITH LEE

Ideal for decorative purposes. Designed to be disposed after one use. White.

18107900 301014 4" dia. 10,000/cs.

18107905 301015 5" dia. 10,000/cs.

18107910 301016 6" dia. 10,000/cs.

18107920 301018 8" dia. 5000/cs.

18107925 3010110 10" dia. 5000/cs.

18107930 3010112 12" dia. 5000/cs.

E. LACE DOILY SMITH LEE

Cake lace design doily. White.

18100041 3011616 16" dia. 2000/cs.

F. ROSE LINEN DOILY SMITH LEE

Rose Linen embossed glassine design doily. White.

18107345 302345 5" 10,000/cs.

Cutlery



CUTLERY

A. TASTER SPOONS

PRIME SOURCE®

Taster spoons.

Polypropylene

75000073 75000073 White, Mediumweight 3000/cs.

Polystyrene

75002529 75002529 3", White, Lightweight 250/cs.

75002677 75002677 White 3000/cs.

75002778 75002778 White 3000/cs.

B. MEDIUMWEIGHT POLYSTYRENE DISPOSABLE CUTLERY

PRIME SOURCE®

Made from polystyrene, specifically engineered for the ideal combination of size, balance, and strength. Trim, sleek styling is contemporary and comfortable to use.

Bulk - Black

75002509 75002509 Teaspoon 1000/cs.

75002508 75002508 Soup Spoon 1000/cs.

75002506 75002506 Fork 1000/cs.

75002505 75002505 Knife 1000/cs.

Bulk - Clear

75002514 75002514 Teaspoon 1000/cs.

75002513 75002513 Soup Spoon 1000/cs.

75002511 75002511 Fork 1000/cs.

75002510 75002510 Knife 1000/cs.

Bulk - White

75002559 75002559 Teaspoon 1000/cs.

75002558 75002558 Soup Spoon 1000/cs.

75002556 75002556 Fork 1000/cs.

75002555 75002555 Knife 1000/cs.

Wrapped - Black

75000069 75000069 Teaspoon 1000/cs.

75000071 75000071 Soup Spoon 1000/cs.

75000068 75000068 Fork 1000/cs.

75000070 75000070 Knife 1000/cs.

Wrapped - White

75002314 75002314 Teaspoon 1000/cs.

75002313 75002313 Soup Spoon 1000/cs.

75002311 75002311 Fork 1000/cs.

75002310 75002310 Knife 1000/cs.

C. HEAVYWEIGHT POLYSTYRENE DISPOSABLE CUTLERY

PRIME SOURCE®

Made from polystyrene, specifically engineered for the ideal combination of size, balance, and strength. Trim, sleek styling is contemporary and comfortable to use.

Bulk - White

75000050 75000050 Teaspoon 1000/cs.

75000051 75000051 Soup Spoon 1000/cs.

75000049 75000049 Fork 1000/cs.

75000048 75000048 Knife 1000/cs.

C. HEAVYWEIGHT POLYSTYRENE DISPOSABLE CUTLERY (CONT.)

PRIME SOURCE®

Wrapped - Black

75002304 75002304 Teaspoon 1000/cs.

75002305 75002305 Soup Spoon 1000/cs.

75002301 75002301 Fork 1000/cs.

75002300 75002300 Knife 1000/cs.

Wrapped - Clear

75000111 75000111 Teaspoon 1000/cs.

75000113 75000113 Soup Spoon 1000/cs.

75000110 75000110 Fork 1000/cs.

75000112 75000112 Knife 1000/cs.

D. MEDIUMWEIGHT POLYPROPYLENE DISPOSABLE CUTLERY

PRIME SOURCE®

Made from break-resistant polypropylene for extended use. Specifically engineered for the ideal combination of size, balance, and strength. Trim, sleek styling is contemporary and comfortable to use.

Bagged (100 ct.) - White

75002499 75002499 Teaspoon 1000/cs.

75002498 75002498 Soup Spoon 1000/cs.

75002497 75002497 Spork 1000/cs.

75002496 75002496 Fork 1000/cs.

75002495 75002495 Knife 1000/cs.

Bulk - Black

75002504 75002504 Teaspoon 1000/cs.

75002503 75002503 Soup Spoon 1000/cs.

75002502 75002502 Spork 1000/cs.

75002501 75002501 Fork 1000/cs.

75002500 75002500 Knife 1000/cs.

Bulk - White

75002494 75002494 Teaspoon 1000/cs.

75002493 75002493 Soup Spoon 1000/cs.

75002492 75002492 Spork 1000/cs.

75002491 75002491 Fork 1000/cs.

75002490 75002490 Knife 1000/cs.

Bulk (Economy) - White

75002694 75002694 Teaspoon 1000/cs.

75002693 75002693 Soup Spoon 1000/cs.

75002692 75002692 Spork 1000/cs.

75002690 75002690 Knife 1000/cs.

75002691 75002691 Fork 1000/cs.

Wrapped - White

75002485 75002485 Teaspoon 1000/cs.

75002484 75002484 Soup Spoon 1000/cs.

75002483 75002483 Spork 1000/cs.

75002482 75002482 Fork 1000/cs.

75002481 75002481 Knife 1000/cs.

Cutlery



A - D

A. MED-HEAVYWEIGHT POLYPROPYLENE DISPOSABLE CUTLERY PRIME SOURCE®

Made from break-resistant polypropylene for extended use. Specifically engineered for the ideal combination of size, balance, and strength. Trim, sleek styling is contemporary and comfortable to use. Wrapped.

75002400 75002400 Teaspoon, White 1000/cs.

B. HEAVYWEIGHT POLYPROPYLENE DISPOSABLE CUTLERY PRIME SOURCE®

Made from break-resistant polypropylene for extended use. Specifically engineered for the ideal combination of size, balance, and strength. Trim, sleek styling is contemporary and comfortable to use. Wrapped.

Black
75002929 75002929 Teaspoon 1000/cs.

75002928 75002928 Soup Spoon 1000/cs.

75002926 75002926 Fork 1000/cs.

75002925 75002925 Knife 1000/cs.

White
75002944 75002944 Teaspoon 1000/cs.

75002943 75002943 Soup Spoon 1000/cs.

75002941 75002941 Fork 1000/cs.

75002940 75002940 Knife 1000/cs.

Bulk - White
75002574 75002574 Teaspoon 1000/cs.

75002573 75002573 Soup Spoon 1000/cs.

75002571 75002571 Fork 1000/cs.

75002570 75002570 Knife 1000/cs.

C. MEDIUMWEIGHT DISPOSABLE CUTLERY PRIME SOURCE®

Specifically engineered for the ideal combination of size, balance, and strength. Trim, sleek styling is contemporary and comfortable to use.

Bulk - Almond
75002604 75002604 Teaspoon 1000/cs.

75002603 75002603 Soup Spoon 1000/cs.

75002601 75002601 Fork 1000/cs.

75002600 75002600 Knife 1000/cs.

Bulk - White
75002815 75002815 Knife, P/P 1000/cs.

75002825 75002825 Knife, (Premium), P/S 1000/cs.

Individually Wrapped

75002599 75002599 Teaspoon 1000/cs.

75002598 75002598 Soup Spoon 1000/cs.

75002596 75002596 Fork 1000/cs.

75002595 75002595 Knife 1000/cs.

75002820 75002820 Knife 1000/cs.

Wrapped - Black
75002684 75002684 Teaspoon 1000/cs.

75002683 75002683 Soup Spoon 1000/cs.

75002682 75002682 Spork 1000/cs.

75002681 75002681 Fork 1000/cs.

75002680 75002680 Knife 1000/cs.

C. MEDIUMWEIGHT DISPOSABLE CUTLERY (CONT.) PRIME SOURCE®

Wrapped - White

75002755 75002755 Teaspoon 1000/cs.

75002754 75002754 Soup Spoon 1000/cs.

75002753 75002753 Spork 1000/cs.

75002752 75002752 Fork 1000/cs.

75002751 75002751 Knife 1000/cs.

D. HEAVYWEIGHT DISPOSABLE CUTLERY PRIME SOURCE®

Specifically engineered for the ideal combination of size, balance, and strength. Trim, sleek styling is contemporary and comfortable to use.

Boxed - Almond

75002649 75002649 Teaspoon 1000/cs.

75002648 75002648 Soup Spoon 1000/cs.

75002646 75002646 Fork 1000/cs.

75002645 75002645 Knife 1000/cs.

Boxed - Black

75002629 75002629 Teaspoon 1000/cs.

75002548 75002548 Soup Spoon, P/P 1000/cs.

75002628 75002628 Soup Spoon, P/S 1000/cs.

75002626 75002626 Fork 1000/cs.

75002625 75002625 Knife 1000/cs.

Boxed - Clear

75002639 75002639 Teaspoon 1000/cs.

75002638 75002638 Soup Spoon 1000/cs.

75002636 75002636 Fork 1000/cs.

75002635 75002635 Knife 1000/cs.

Boxed w/Window - White

75002619 75002619 Teaspoon 1000/cs.

75002618 75002618 Soup Spoon 1000/cs.

75002616 75002616 Fork 1000/cs.

75002615 75002615 Knife 1000/cs.

Bulk - Almond

75002609 75002609 Teaspoon 1000/cs.

75002608 75002608 Soup Spoon 1000/cs.

75002606 75002606 Fork 1000/cs.

75002605 75002605 Knife 1000/cs.

Bulk - Black

75002549 75002549 Teaspoon, P/P 1000/cs.

75002564 75002564 Teaspoon, P/S 1000/cs.

75002563 75002563 Soup Spoon, P/S 1000/cs.

75002546 75002546 Fork, P/P 1000/cs.

75002561 75002561 Fork, P/S 1000/cs.

75002545 75002545 Knife, P/P 1000/cs.

75002560 75002560 Knife, P/S 1000/cs.

Bulk - Clear

75002569 75002569 Teaspoon 1000/cs.

75002568 75002568 Soup Spoon 1000/cs.

75002566 75002566 Fork 1000/cs.

75002565 75002565 Knife 1000/cs.

Cutlery



A - B



A. HEAVYWEIGHT DISPOSABLE CUTLERY (CONT.)

PRIME SOURCE®

Bulk - White

75002554	75002554	Teaspoon	1000/cs.
75002553	75002553	Soup Spoon	1000/cs.
75002551	75002551	Fork	1000/cs.
75002550	75002550	Knife	1000/cs.

Bulk (Economy) - Black

75002874	75002874	Teaspoon	1000/cs.
75002871	75002871	Fork	1000/cs.
75002870	75002870	Knife	1000/cs.

Bulk (Economy) - White

75002544	75002544	Teaspoon	1000/cs.
75002543	75002543	Soup Spoon	1000/cs.
75002541	75002541	Fork	1000/cs.
75002540	75002540	Knife	1000/cs.

B. EXTRA HEAVYWEIGHT DISPOSABLE CUTLERY

PRIME SOURCE®

Specifically engineered for the ideal combination of size, balance, and strength. Trim, sleek styling is contemporary and comfortable to use.

Boxed - Almond

75002654	75002654	Teaspoon	1000/cs.
75002653	75002653	Soup Spoon	1000/cs.
75002651	75002651	Fork	1000/cs.
75002650	75002650	Knife	1000/cs.

Boxed - Black

75002634	75002634	Teaspoon	1000/cs.
75002633	75002633	Soup Spoon	1000/cs.
75002631	75002631	Fork	1000/cs.
75002630	75002630	Knife	1000/cs.

Boxed - Clear

75002644	75002644	Teaspoon	1000/cs.
75002643	75002643	Soup Spoon	1000/cs.
75002641	75002641	Fork	1000/cs.
75002640	75002640	Knife	1000/cs.

Boxed - White

75002624	75002624	Teaspoon	1000/cs.
75002623	75002623	Soup Spoon	1000/cs.
75002621	75002621	Fork	1000/cs.
75002620	75002620	Knife	1000/cs.

Boxed (Economy) - Almond

76002656	76002656	Fork	1000/cs.
----------	----------	------	----------

Boxed (Economy) - Black

76002641	76002641	Fork	1000/cs.
----------	----------	------	----------

Boxed (Economy) - Clear

76002644	76002644	Teaspoon	1000/cs.
76002643	76002643	Soup Spoon	1000/cs.
76002640	76002640	Knife	1000/cs.

Boxed (Economy) - White

75002689	75002689	Teaspoon	1000/cs.
75002688	75002688	Soup Spoon	1000/cs.

B. EXTRA HEAVYWEIGHT DISPOSABLE CUTLERY (CONT.)

PRIME SOURCE®

Boxed (Economy) - White (Cont.)

75002686	75002686	Fork	1000/cs.
75002685	75002685	Knife	1000/cs.

Bulk - Almond

75002614	75002614	Teaspoon	1000/cs.
75002613	75002613	Soup Spoon	1000/cs.
75002611	75002611	Fork	1000/cs.
75002610	75002610	Knife	1000/cs.

Bulk - Black

75002579	75002579	Teaspoon	1000/cs.
75002578	75002578	Soup Spoon	1000/cs.
75002576	75002576	Fork	1000/cs.
75002575	75002575	Knife	1000/cs.

Bulk - Clear

75002584	75002584	Teaspoon	1000/cs.
75002583	75002583	Soup Spoon	1000/cs.
75002581	75002581	Fork	1000/cs.
75002580	75002580	Knife	1000/cs.

Bulk - White

75002589	75002589	Teaspoon	1000/cs.
75002588	75002588	Soup Spoon	1000/cs.
75002586	75002586	Fork	1000/cs.
75002585	75002585	Knife	1000/cs.

Bulk (Economy) - Almond

76002614	76002614	Teaspoon	1000/cs.
76002613	76002613	Soup Spoon	1000/cs.
76002611	76002611	Fork	1000/cs.
76002610	76002610	Knife	1000/cs.

Bulk (Economy) - Black

76002579	76002579	Teaspoon	1000/cs.
76002578	76002578	Soup Spoon	1000/cs.
76002576	76002576	Fork	1000/cs.
76002575	76002575	Knife	1000/cs.

Bulk (Economy) - Clear

76002581	76002581	Fork	1000/cs.
76002580	76002580	Knife	1000/cs.

Bulk (Economy) - Honey

75002836	75002836	Fork	1000/cs.
75002835	75002835	Knife	1000/cs.

Bulk (Economy) - White

75002699	75002699	Teaspoon	1000/cs.
75002698	75002698	Soup Spoon	1000/cs.
75002696	75002696	Fork	1000/cs.
75002695	75002695	Knife	1000/cs.

Wrapped - White

75002942	75002942	Teaspoon	1000/cs.
75002946	75002946	Soup Spoon	1000/cs.
75002937	75002937	Fork	1000/cs.
75002945	75002945	Knife	1000/cs.

RESTAURANT & BAR SUPPLIES

Cutlery



A. MEDIUMWEIGHT DISPOSABLE CUTLERY GEORGIA PACIFIC FOODSERVICE

Mediumweight polypropylene construction provides rigidity and strength. Strong, shatter resistant and durable. Dense pack.

15000602	PTM21	Teaspoon, 5 ³ / ₄ ", White	1000/cs.
15000921	PFM21	Fork, 6", White	1000/cs.
15003021	PKM21	Knife, 6 ⁵ / ₁₆ ", White	1000/cs.

B. HEAVY MEDIUMWEIGHT DISPOSABLE CUTLERY GEORGIA PACIFIC FOODSERVICE

Heavy mediumweight polystyrene cutlery. Upscale image at a value price. Strong, shatter resistant and durable. Equivalent to many competitors heavyweight offering. Saves time, labor and money. No short counts or broken pieces, guaranteed.

Dense Pack™			
15007417	TM21	Teaspoon, 5 ⁷ / ₈ ", White	1000/cs.
15008051	SM51	Soup Spoon, 5 ³ / ₄ ", Black	1000/cs.
15000077	SM21	Soup Spoon, 5 ³ / ₄ ", White	1000/cs.
15002051	FM51	Fork, 6 ⁵ / ₁₆ ", Black	1000/cs.
15007416	FM21	Fork, 6 ⁵ / ₁₆ ", White	1000/cs.
15007415	KM21	Knife, 7", White	1000/cs.
Boxed			
15002055	TM20	Teaspoon, 5 ⁷ / ₈ ", White	1000/cs.



C. DIXIE® HEAVY MEDIUMWEIGHT DISPOSABLE CUTLERY GEORGIA PACIFIC FOODSERVICE

Heavy mediumweight polystyrene cutlery. Equivalent to many competitors heavyweight offering. Strong, shatter resistant and durable.

Dense Pack™			
15001991	TM517	Teaspoon, 5 ⁷ / ₈ ", Black, 1000 ct.	1000/cs.
15001992	FM517	Fork, 6 ¹ / ₃ ", Black, 1000 ct.	1000/cs.
15001990	KM517	Knife, 7", Black, 1000 ct.	1000/cs.
15007418	TM217	Teaspoon, 5 ⁷ / ₈ ", White, 1000 ct.	1000/cs.
15007419	FM217	Fork, 6 ¹ / ₃ ", White, 1000 ct.	1000/cs.
15007420	KM217	Knife, 7", White, 1000 ct.	1000/cs.
Boxed			
15000418	TM507	Teaspoon, 5 ⁷ / ₈ ", Black 100 ct.	1000/cs.
15000416	FM507	Fork, 6 ¹ / ₃ ", Black, 100 ct.	1000/cs.
15000417	KM507	Knife, 7", Black, 100 ct.	1000/cs.
15002056	TM207	Teaspoon, 5 ⁷ / ₈ ", White, 100 ct.	1000/cs.
15000245	SM207	Soup Spoon, 5 ³ / ₄ ", White, 100 ct.	1000/cs.
15001027	FM207	Fork, 6 ¹ / ₃ ", White, 100 ct.	1000/cs.
15002016	KM207	Knife, 7", White, 100 ct.	1000/cs.



D. DIXIE® HEAVYWEIGHT DISPOSABLE CUTLERY GEORGIA PACIFIC FOODSERVICE

Heavyweight polystyrene is the premium choice in cutlery and the next best thing to silverware.

Dense Pack™			
15005154	TH517	Teaspoon, 6", Black, 1000 ct.	1000/cs.
15005153	FH517	Fork, 7 ¹ / ₈ ", Black, 1000 ct.	1000/cs.
15002652	KH517	Knife, 7 ¹ / ₂ ", Black, 1000 ct.	1000/cs.
15005622	TH217	Teaspoon, 6", White, 1000 ct.	1000/cs.
15000095	FH217	Fork, 7 ¹ / ₈ ", White, 1000 ct.	1000/cs.
15006815	KH217	Knife, 7 ¹ / ₂ ", White, 1000 ct.	1000/cs.
Boxed			
15000387	TH207	Teaspoon, 6", White, 100 ct.	1000/cs.
15006814	SH207	Soup Spoon, 5 ³ / ₄ ", White, 100 ct.	1000/cs.
15000380	FH207	Fork, 7 ¹ / ₈ ", White, 100 ct.	1000/cs.
15000384	KH207	Knife, 7 ¹ / ₂ ", White, 100 ct.	1000/cs.

Cutlery



A. HEAVYWEIGHT DISPOSABLE CUTLERY GEORGIA PACIFIC FOODSERVICE

Premium heavyweight cutlery, the next best thing to silverware. Strong, shatter resistant and durable. Dense pack.

15005151	TH51	Teaspoon, 6", Black	1000/cs.
15005152	FH51	Fork, 7 1/8", Black	1000/cs.
15002651	KH51	Knife, 7 1/2", Black	1000/cs.
15000383	FH11	Fork, 7 1/8", Champagne	1000/cs.
15001501	KH01	Knife, 7 1/2", Crystal	1000/cs.



B. DIXIE® WRAPPED HEAVYWEIGHT CUTLERY GEORGIA PACIFIC FOODSERVICE

Individually wrapped heavyweight polypropylene cutlery is convenient and sanitary.

15003017	PTH53C	Teaspoon, Black	1000/cs.
15003016	PFH53C	Fork, Black	1000/cs.
15003015	PKH53C	Knife, Black	1000/cs.



C. SMARTSTOCK™ DISPOSABLE CUTLERY GEORGIA PACIFIC FOODSERVICE

There isn't a more efficient or orderly way for you to stock, and your customers to select, the cutlery that is an essential part of your everyday foodservice operation. These pre-counted and pre-assembled refills make it fast and easy to restock an empty dispenser. Just pick up a new cutlery refill, slide it into the dispenser, rip and pull away the binding tape, close the door and you're done.

15008807	SSS51	Spoon (Refill), 6", Black	960/cs.
15008808	SSF51	Fork (Refill), 6 1/2", Black	960/cs.
15008809	SSK51	Knife (Refill), 7", Black	960/cs.



D. DISPOSABLE TASTER SPOON SOLO®

Made with convenience in mind.

18203603	000800222	3", White	3000/cs.
----------	-----------	-----------	----------

E. MAJESTIC™ MEDIUMWEIGHT CUTLERY SOLO®

When you want your takeout experience to leave nothing to chance, Solo's Majestic line delivers. From cutting through a deluxe deli sandwich, to spearing grilled satay skewers, our Majestic mediumweight polystyrene cutlery stands up to the test, beautifully.

Bulk

18200249	MSWF0007	Fork, White	1000/cs.
18200253	MSWK0007	Knife, White	1000/cs.

Individually Wrapped

18200284	MSW30007	Teaspoon, White	1000/cs.
----------	----------	-----------------	----------

F. REGAL™ BULK CUTLERY SOLO®

With options abound, Regal is another excellent choice. Regal's mediumweight and larger size is perfect for takeout dishes and steam-table catering functions. Mediumweight.

18200455	MOWC0007	Spork, White	1000/cs.
18207007	MOWF0007	Fork, White	1000/cs.
18207011	MOWT0007	Teaspoon, White	1000/cs.



G. REGAL™ WHITE DISPOSABLE CUTLERY SOLO®

The economical disposable alternative to standard tableware.

18205205	057000007	Teaspoon	1000/cs.
18208817	058500007	Soup Spoon	1000/cs.
18205210	057500007	Fork	1000/cs.
18202580	058000007	Knife	1000/cs.

Mediumweight - Bulk

18205220	05900	Spork	1000/cs.
18205950	05950	Soda Spoon	1000/cs.

Mediumweight - Individually Wrapped

18208310	61070	Teaspoon	1000/cs.
18208325	61370	Soup Spoon	1000/cs.
18200871	MOW60007	Spork	1000/cs.
18202315	61170	Fork	1000/cs.
18206127	61270	Knife	1000/cs.



Cutlery



A. GUILDWARE® DISPOSABLE CUTLERY SOLO®

Strong plastic cutlery. Full size premiere quality. Designer styling, slim lines. Richly textured handles.

Boxed

18701955	GBX7TS0019	Teaspoon, Champagne	1000/cs.
18701954	GBX8SS0019	Soup Spoon, Champagne	1000/cs.
18701940	GBX5FK0019	Fork, Champagne	1000/cs.
18701945	GBX6KN0019	Knife, Champagne	1000/cs.
18200854	GBX7TW0007	Teaspoon, White	1000/cs.
18700112	GBX8SW0007	Soup Spoon, White	1000/cs.
18200856	GBX5FW0007	Fork, White	1000/cs.
18200855	GBX6KW0007	Knife, White	1000/cs.

Bulk

18700108	GDR7TS0004	Teaspoon, Black	1000/cs.
18700109	GDR8SS0004	Soup Spoon, Black	1000/cs.
18700106	GDR5FK0004	Fork, Black	1000/cs.
18700107	GDR6KN0004	Knife, Black	1000/cs.
18701920	GD7TS0019	Teaspoon, Champagne	1000/cs.
18701930	GD8SS0019	Soup Spoon, Champagne	1000/cs.
18701905	GD5FK0019	Fork, Champagne	1000/cs.
18701915	GD6KN0019	Knife, Champagne	1000/cs.
18700104	GDC7TS0090	Teaspoon, Clear	1000/cs.
18700103	GDC5FK0090	Fork, Clear	1000/cs.
18700102	GDC6KN0090	Knife, Clear	1000/cs.
18701925	GD7TW0007	Teaspoon, White	1000/cs.
18701910	GD5FW0007	Fork, White	1000/cs.
18701917	GD6KW0007	Knife, White	1000/cs.

B. SIMPLE ELEGANCE® BOXED CUTLERY SOLO®

For higher-end usage, our Simple Elegance cutlery keeps the cachet of your menu intact. Count on excellent performance every time.

Mid-Heavyweight - Boxed

18705764	SBX7TW0007	Teaspoon, White	1000/cs.
18705768	SBX8SW0007	Soup Spoon, White	1000/cs.
18705748	SBX5FW0007	Fork, White	1000/cs.
18705756	SBX6KW0007	Knife, White	1000/cs.

Mid-Heavyweight - Bulk

18705720	SEL7TS0019	Teaspoon, Champagne	1000/cs.
18705728	SEL8SS0019	Soup Spoon, Champagne	1000/cs.
18705704	SEL5FK0019	Fork, Champagne	1000/cs.
18208120	SEL6KN0019	Knife, Champagne	1000/cs.
18705724	SEL8SW0007	Soup Spoon, White	1000/cs.

C. CLASSIC HEAVYWEIGHT CUTLERY SOLO®

For the poolside reception or special occasion where both convenience and quality must be served, there is Solo Classic. This "classic" design is extra sturdy, full-size and heavyweight.

Boxed

18204001	100120001	Fork, Clear	1000/cs.
18202033	100020222	Teaspoon, Sandstone	1000/cs.
18202028	100000001	Fork, Sandstone	1000/cs.
18202031	100010222	Knife, Sandstone	1000/cs.
18202039	100060222	Teaspoon, White	1000/cs.
18202041	100040001	Fork, White	1000/cs.
18202042	100050222	Knife, White	1000/cs.

Cutlery



A. CLASSIC HEAVYWEIGHT CUTLERY (CONT.)

SOLO®

Bulk			
18203037	100260222	Teaspoon, Black	1000/cs.
18202700	100270222	Soup Spoon, Black	1000/cs.
18204035	100240001	Fork, Black	1000/cs.
18203036	100250222	Knife, Black	1000/cs.
18209030	100300222	Teaspoon, Clear	1000/cs.
18209028	100280001	Fork, Clear	1000/cs.
18209029	100290222	Knife, Clear	1000/cs.
18201708	100180222	Teaspoon, Sandstone	1000/cs.
18201707	100160001	Fork, Sandstone	1000/cs.
18202026	100220222	Teaspoon, White	1000/cs.
18202025	100200001	Fork, White	1000/cs.
18202027	100210222	Knife, White	1000/cs.



B. REFLECTIONS™ DISPOSABLE CUTLERY

WNA COMET

Reflections cutlery combines the radiant styling of fine flatware and the ease of single use. The only solution addressing the need for a formal presentation and the high costs associated with renting or owning permanent flatware.

12201432	620155	Spoon, 6 1/4", Silver	600/cs.
12201430	610155	Fork, 7", Silver	600/cs.
12201431	630155	Knife, 7 1/2", Silver	600/cs.



ECO-FRIENDLY CUTLERY

C. NATURE FRIENDLY® CUTLERY

NATURE FRIENDLY PRODUCTS

Made from a proprietary biodegradable resin. 100% biodegradable and compostable. Completely compostable within 50-100 days in properly managed composting facilities. Superior strength, quality performance. High temperature resistant up to 190°F. Impermeable and non-toxic.

Bulk/1000 pc.

C6935009	CHW302	Spoon	1000/cs.
C6935007	CHW102	Fork	1000/cs.
C6935008	CHW202	Knife	1000/cs.

Bulk/2000 pc.

C6935003	CHW300	Spoon	20/100/cs.
C6935001	CHW100	Fork	20/100/cs.
C6935002	CHW200	Knife	20/100/cs.

Individually Wrapped/500 pc.

C6935006	CHW301	Spoon	5/100/cs.
C6935004	CHW101	Fork	5/100/cs.
C6935005	CHW201	Knife	5/100/cs.

4 Boxes/300 pc.

C6935050	CHW1200	Cutlery Combo Kit	1200/cs.
----------	---------	-------------------	----------



D. BIOPLASTIC CUTLERY

TRELLIS EARTH™

Bagged in a Trellis Earth™ biodegradable bioplastic bag for a complete environmentally responsible package. Bioplastic cutlery is made from corn polymers, starches and complementary ingredients to create a blend that is 100% biodegradable and microwave or freezer safe. Just as effective as conventional plastic cutlery.

C4780045	WFS10	Soup Spoon	1000/cs.
C4780033	WFS03	Spoon	3000/cs.
C4780054	WFS13	Spork	1000/cs.
C4780002	WFS02	Fork	1000/cs.
C4780004	WFS04	Knife	1000/cs.



Cutlery



A. BIOPLASTIC CUTLERY TRELLIS EARTH™

Retail inner packs include six inner cartons ready for stocking on shelves. Each inner retail pack is bar coded.

C4780094	<i>WFS58</i>	Soup Spoon, White, 100 ct.	600/cs.
C4780069	<i>WFS68</i>	Soup Spoon, White, 500 ct.	3000/cs.
C4780092	<i>WFS53</i>	Spoon, White, 100 ct.	600/cs.
C4780071	<i>WFS66</i>	Spoon, White, 500 ct.	3000/cs.
C4780076	<i>WFS74</i>	Fork, White, 60 ct.	
C4780091	<i>WFS52</i>	Fork, White, 100 ct.	600/cs.
C4780072	<i>WFS65</i>	Fork, White, 500 ct.	3000/cs.
C4780093	<i>WFS54</i>	Knife, White, 100 ct.	600/cs.
C4780070	<i>WFS67</i>	Knife, White, 500 ct.	3000/cs.

B. BIOPLASTIC CUTLERY SETS TRELLIS EARTH™

Cover all the bases with these three-piece cutlery sets of bioplastic forks, knives, and spoons. Your customers will be pleasantly surprised when they see their takeout order packed with our eco-friendly cutlery. Bioplastic cutlery is made from corn polymers, starches and complementary ingredients to create a blend that is 100% biodegradable and microwave or freezer safe. Just as effective as conventional plastic cutlery.

C4780074	<i>WFS71</i>	60 ct., 20 Each (Spoon, Fork, Knife)	1200/cs.
C4780090	<i>WFS51</i>	150 ct., 50 Each (Spoon, Fork, Knife)	900/cs.
C4780075	<i>WFS72</i>	150 ct., 50 Each (Spoon, Fork, Knife)	2400/cs.
C4780073	<i>WFS61</i>	450 ct., 200 Fork, 150 Spoon, 100 Knife	2700/cs.
C4780018	<i>WFS01</i>	250 Sets, Bagged, Basic	1000/cs.
C4780064	<i>WFS31</i>	250 Sets, Bagged, Premium	1000/cs.

C. BULK BIOPLASTIC CUTLERY TRELLIS EARTH™

Made from corn polymers, starches and complementary ingredients to create a blend that is 100% biodegradable and microwave or freezer safe.

C4780024	<i>WFS08</i>	Soup Spoon, 100 ct.	1000/cs.
C4780055	<i>WFS11</i>	Tasting Spoon, 1000 ct.	1000/cs.
C4780006	<i>WFS06</i>	Spoon, 100 ct.	1000/cs.
C4780063	<i>CTS03</i>	Tasting Spork, 500 ct.	2500/cs.
C4780023	<i>WFS09</i>	Spork, 100 ct.	1000/cs.
C4780005	<i>WFS05</i>	Fork, 100 ct.	1000/cs.
C4780007	<i>WFS07</i>	Knife, 100 ct.	1000/cs.

D. PREMIUM BIOPLASTIC CUTLERY TRELLIS EARTH™

Premium BioPlastic is stronger, heavier and more rigid than basic cutlery. Works beyond boiling, up to 248°F. Textured handles with Trellis trademark. Made from corn polymers, starches and complementary ingredients to create a blend that is 100% biodegradable and microwave or freezer safe.

C4780081	<i>WFS36</i>	Spoon, Beige, 100 ct.	1000/cs.
C4780080	<i>WFS35</i>	Fork, Beige, 100 ct.	1000/cs.
C4780082	<i>WFS37</i>	Knife, Beige, 100 ct.	1000/cs.

E. MALIBU COMPOSTABLE CUTLERY WNA COMET

Mediumweight disposable cutlery. Meets ASTM D6400 for biopolymers. Also compost using Cedar Grove's stringent test methods.

12200194	<i>CGFB120165</i>	Spoon, Brown	600/cs.
12200195	<i>CGFB120265</i>	Fork, Brown	600/cs.
12200189	<i>CGFB120365</i>	Knife, Brown	600/cs.

F. STATESMEN COMPOSTABLE CUTLERY WNA COMET

Our compostable line of products is an ecologically sound and practical choice. Earthsense™ offers superior performance and appearance vs. other "green" disposable products. Meets ASTM D6400 for biopolymers. Also compost using Cedar Grove's stringent test methods. Heavyweight.

12200149	<i>CGFB420605</i>	Spoon, Brown	600/cs.
12200150	<i>CGFB410605</i>	Fork, Brown	600/cs.
12200148	<i>CGFB430605</i>	Knife, Brown	600/cs.

Cutlery Kits



CUTLERY KITS

A. DISPOSABLE CUTLERY KITS

PRIME SOURCE®

Specifically engineered for the ideal combination of size, balance and strength. Trim, sleek styling is contemporary and comfortable to use.

Mediumweight

75002880 75002880 3 Pc. (Spork, Straw, Napkin) 1000/cs.

Mediumweight - Black

75002533 75002533 3 Pc. (Fork, Knife, 1-Ply Napkin) 500/cs.

75002675 75002675 5 Pc. (Teaspoon, Fork, Knife, Salt/Pepper, 13" x 17" Napkin) 250/cs.

Mediumweight - Clear

75000114 75000114 3 Pc. (Fork, Knife, 12" x 13" 1-Ply Napkin) 1000/cs.

Mediumweight - White

75000072 75000072 3 Pc. (Fork, Knife, 12" x 13" 1-Ply Napkin) 250/cs.

75000107 75000107 3 Pc. (Spork, 5³/₄" Milk Straw, 10" x 10" 1-Ply Napkin) 1000/cs.

75000108 75000108 3 Pc. (Spork, 5³/₄" Milk Straw, 10" x 12" 1-Ply Napkin) 1000/cs.

75002480 75002480 3 Pc. (Spork, 5" Clear Straw, 10" x 10" Napkin) 1000/cs.

75002517 75002517 3 Pc. (Teaspoon, Fork, Knife) 500/cs.

75002526 75002526 3 Pc. (Spork, 5" Straw, 10" x 8" 1-Ply Napkin) 1000/cs.

75002528 75002528 3 Pc. (Fork, Knife, 8" x 10" Napkin) 500/cs.

75002723 75002723 3 Pc. (Fork, Knife, Napkin) 500/cs.

75002724 75002724 3 Pc. (Fork, Knife, Napkin) 500/cs.

75000052 75000052 4 Pc. (Teaspoon, Fork, Knife, Napkin) 250/cs.

75002475 75002475 4 Pc. (Teaspoon, Soup Spoon, Fork, Knife) 250/cs.

75002476 75002476 4 Pc. (Fork, Knife, Salt/Pepper, 12" x 13" Napkin) 250/cs.

75002479 75002479 4 Pc. (Teaspoon, Fork, Knife, 13" x 10¹/₂" 1-Ply Napkin) 250/cs.

75002486 75002486 4 Pc. (Fork, Knife, Salt/Pepper, 10" x 10" 1-Ply Napkin) 1000/cs.

75002892 75002892 4 Pc. (Fork, Knife, Salt/Pepper, 13" x 13" Napkin) 250/cs.

75002896 75002896 4 Pc. (Teaspoon, Fork, 6" Straw, 10" x 10" Napkin) 500/cs.

75002897 75002897 4 Pc. (Teaspoon, Fork, Salt/Pepper, 10" x 12" Napkin) 500/cs.

75000109 75000109 5 Pc. (Teaspoon, Fork, Knife, 5³/₄" Milk Straw, 10" x 12" 1-Ply Napkin) 1000/cs.

75002477 75002477 5 Pc. (Teaspoon, Fork, Knife, Salt/Pepper, 12" x 13" Napkin) 250/cs.

75002487 75002487 5 Pc. (Teaspoon, Fork, Knife, Salt/Pepper, 10" x 10" Napkin) 250/cs.

75002489 75002489 5 Pc. (Teaspoon, Fork, Knife, 6" Straw, 12" x 13" Napkin) 500/cs.

75002516 75002516 5 Pc. (Teaspoon, Fork, Knife, Salt/Pepper, 10" x 10" Napkin) 250/cs.

Heavyweight - Black

75002877 75002877 5 Pc. (Teaspoon, Fork, Knife, Salt/Pepper, 13" x 17" Napkin) 250/cs.

75002900 75002900 5 Pc. (Fork, Knife, Teaspoon, Salt/Pepper, 13" x 17" Napkin) 250/cs.

Heavyweight - White

75000053 75000053 4 Pc. (Teaspoon, Fork, Knife, Napkin) 250/cs.

75002524 75002524 4 Pc. (Fork, Knife, Salt/Pepper, 12" x 13" Napkin) 250/cs.

Extra Heavyweight - Black

75002878 75002878 5 Pc. (Teaspoon, Fork, Knife, Salt/Pepper, 13" x 17" Napkin) 250/cs.



RESTAURANT & BAR SUPPLIES

Cutlery Kits/Guest Checks



A. DISPOSABLE CUTLERY KITS (CONT.) PRIME SOURCE®

Economy - White			
75002593	75002593	4 Pc. (Fork, Knife, Salt/Pepper, 10" x 10" 1-Ply Napkin)	250/cs.
75002594	75002594	5 Pc. (Teaspoon, Fork, Knife, Salt/Pepper, 10" x 10" 1-Ply Napkin)	250/cs.

B. DIXIE® CUTLERY COMBO BOX GEORGIA PACIFIC FOODSERVICE

Heavy-duty forks, knives and teaspoons (56 sets).

15000168	CM168	168 ct., White	168/cs.
----------	-------	----------------	---------

C. DIXIE® CUTLERY KEEPER GEORGIA PACIFIC FOODSERVICE

Full size dinner length cutlery perfect for heavy, tough-to-cut food like steak and chicken. Houses strong, shatter resistant, durable cutlery - saves time, labor, and money. Re-closable plastic tray keeps cutlery organized. Crystal coordinates with any color of pattern. 60 pieces of each essential utensil: knives, forks, teaspoons.

15002182	CH0180DX7	60 Sets, Crystal, Heavyweight	1800/cs.
----------	-----------	-------------------------------	----------

D. DIXIE® CUTLERY KIT GEORGIA PACIFIC FOODSERVICE

Polystyrene wrapped cutlery is convenient and sanitary.

15001130	CH26C7	Teaspoon, Fork, Knife, White, Heavyweight	250/cs.
----------	--------	---	---------

E. DIXIE® CUTLERY KIT GEORGIA PACIFIC FOODSERVICE

Convenience and sanitation all wrapped up. Your choice in wrapped cutlery. Ideal for take out. Convenient and sanitary to use - hands do not come in contact with the cutlery. Strong, shatter resistant and durable. Heavy mediumweight. White.

15002628	CM26NC7	Teaspoon, Knife, Fork, 1-Ply 12" x 16" Napkin	250/cs.
----------	---------	---	---------

F. REGAL™ DISPOSABLE CUTLERY KITS SOLO®

The economical disposable alternative to standard tableware. White. Mediumweight.

18204002	64000	Spork, Straw, 8" x 10" Napkin	1000/cs.
18208825	64085	Fork, Knife, S & P, 13" x 17" Napkin	250/cs.
18200677	64193	Teaspoon, Fork, Knife, 12" x 13" Napkin	500/cs.
18204199	641990222	Teaspoon, Fork, Knife, S & P, 12" x 13" Napkin	250/cs.

G. REGAL™ WRAPPED KIT SOLO®

With options abound, Regal is another excellent choice. Regal's mediumweight and larger size is perfect for takeout dishes and steam-table catering functions. White. Mediumweight.

18207006	MOW8Y0007	Teaspoon, Fork, Knife, S & P, 9" x 13" Napkin	250/cs.
----------	-----------	---	---------

H. REFLECTIONS™ DISPOSABLE CUTLERY KIT WNA COMET

Reflections cutlery combines the radiant styling of fine flatware and the ease of single use. The only solution addressing the need for a formal presentation and the high costs associated with renting or owning permanent flatware.

12201433	612375	Spoon, Fork, Knife, Silver	450/cs.
----------	--------	----------------------------	---------

GUEST CHECKS

I. GUESTCHECK™ SINGLE BOARD GUEST CHECKS NATIONAL CHECKING

Single board check has 15 lines with a "Menu Prompt" for better customer service. Lined back copy for beverages and a perforated receipt for the customer's record. 50 checks per book. May be used in a cash register.

49201908	G3632	3 1/2" x 6 3/4", Green	2500/cs.
49201910	G3632SP	3 1/2" x 6 3/4", Green, Shrink Packed	2500/cs.
		5 Bundles of 10 Books	

J. SINGLE PAPER GUEST CHECKS NATIONAL CHECKING

Single paper green guest check has 16 lines with a "Menu Prompt" for better customer service. A numbered receipt stub is used for accounting purposes. 100 checks per book, 50 books per case.

49203616	G3616	3 1/2" x 6 3/4", Green	5000/cs.
----------	-------	------------------------	----------

Guest Checks/Cash Register Rolls



A. SINGLE BOARD GUEST CHECKS NATIONAL CHECKING

Single board check has 13 lines with a "Menu Prompt" for better customer service. Lined back copy for beverages and a perforated receipt for the customer's record. Safety tinting to protect against fraud. This check may be used on kitchen check holders and in a cash register. 50 checks per book, 50 books per case (shrink wrapped five bundles of 10 books).
49201919 G4774SP 4⁵/₁₆" x 7¹/₄", Green 2500/cs.



B. SINGLE TAG GUEST CHECKS NATIONAL CHECKING

Single tag guest check, 50 checks per book.
20250566 566 4³/₁₆" x 6¹/₂", Green 2500/cs.



C. WAITRPAD® GUEST CHECKS NATIONAL CHECKING

Single paper white Waitrapad® has 13 lines with "Pivot Points" and a "Menu Prompt" for better customer service. 100 checks per book / 100 books per case.
49203516 3516SP 3¹/₂" x 5¹/₈" 10,000/cs.



D. CARBON COATED DUPLICATE LOOSE GUEST CHECKS NATIONAL CHECKING

Carbon coated loose duplicate guest checks. Part 1: 4¹/₄" x 5¹/₂" Part 2: 4¹/₄" x 8¹/₄".
20250021 926SW 4¹/₄" x 5¹/₂", Green, Shrink Wrapped 2500/cs.



E. DUPLICATE PAPER GUEST CHECKS NATIONAL CHECKING

Duplicate paper, carbonless white check has 13 lines with a "Menu Prompt" for better service. Original copy is printed in black and the duplicate in red. Cardboard wrap-around cover prevents multiple copy write-through. 50 sets per book, 100 book per case (shrink wrapped 10 bundles of 10 books).
49200101 101SP 3³/₈" x 5⁵/₈", White 5000/cs.

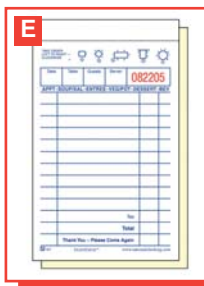

F. DUPLICATE PAPER GUEST CHECKS NATIONAL CHECKING

Duplicate paper, carbonless green check has 17 lines with a "Menu Prompt" for better service. The kitchen copy is unlined and printed on yellow paper. A wrap-around cover prevents write-through and provides server tips for better service. 50 sets per book, 50 books per case.
49201936 G7000 3³/₈" x 6³/₄", Green 25,000/cs.



G. DUPLICATE BOARD GUEST CHECKS NATIONAL CHECKING

Duplicate board, carbonless tan check has 15 lines with "Pivot Points" and a "Menu Prompt" for better service. Lined back copy for beverages and a perforated receipt for the customer's record. A wrap-around cover prevents write-through and provides server tips for better service. Shrink wrapped 8 bundles of 250 sets.
49205816 T4997SP 4¹/₄" x 8¹/₂", Tan 2000/cs.



H. GUESTCHECK™ DUPLICATE PAPER GUEST CHECKS NATIONAL CHECKING

Duplicate paper, interleaving carbon green check has 17 lines with a "Menu Prompt" for better service. The kitchen copy is unlined. 50 sets per book, 50 books per case.
49201930 G6000 3¹/₂" x 6³/₄", Green 2500/cs.

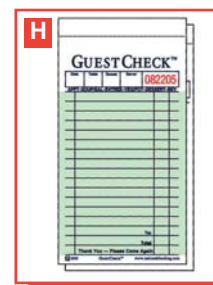

I. TRIPLICATE BOARD GUEST CHECKS NATIONAL CHECKING

Triplicate board, carbonless tan Guestcheck™ has 15 lines with Pivot Points and a Menu Prompt for better service. Lined back copy for beverages and a perforated receipt for the customer's record. 2000 loose sets per case. Shrink packed 8 bundles of 250 sets.
49205814 T49973SP 4¹/₈" x 8¹/₂", Tan 2000/cs.



CASH REGISTER ROLLS

J. REGISTROLLS® CASH REGISTER & PRINTER ROLLS NATIONAL CHECKING

One-ply bond rolls. Utilized in a traditional cash register to generate a receipt of final charges for payment. Typically these registers require two rolls; one for the customer receipt, the other for internal record-keeping of the transaction. 10 rolls per tray, 3 trays per case.
49200037 1300SP 3" x 165", White 30/cs.



RESTAURANT & BAR SUPPLIES

Register Rolls/Rubber Bands/Candles/Fuel/Coffee



A. REGISTRILLS® CASH REGISTER & PRINTER ROLLS (CONT.) NATIONAL CHECKING

Two-ply white/canary bond paper, no carbon. Used in machines that verify the charges against a credit card and is used for the customer to sign. Copy one is kept by the restaurant and copy two is for the customer for their records. 10 rolls per tray, 3 trays per case.

49200041	<i>2300SP</i>	3" x 100', White/Canary	30/cs.
One-ply, thermal. This heat sensitive roll produces a black image from a thermal printer. Utilized in kitchen printers or in a wait station printer to generate an itemized receipt of the customer's charges. White.			
49200047	<i>722580SP</i>	2 1/4" x 80', 24 Rolls/Tray, 2 Trays/Case	48/cs.
49200044	<i>7225SP</i>	2 1/4" x 200', 10 Rolls/Tray, 4 Trays/Case	40/cs.
49200045	<i>7313SP</i>	3 1/8" x 200', 10 Rolls/Tray, 3 Trays/Case	30/cs.



RUBBER BANDS

B. RUBBER BANDS PRIME SOURCE®

Advantage rubber bands.

750002551	<i>75000255</i>	#33, 3 1/2" x 1/8", Red	1/cs.
75000255	<i>75000255</i>	#33, 3 1/2" x 1/8", Red	25/cs.

CANDLES



C. AMBRIA® VOTIVE CANDLES STERNO

Food warmer candle.

25080510	<i>510FW</i>	10 hr., 1 7/16" x 1 1/2", White	288/cs.
25080516	<i>516FW</i>	15 hr., 1 3/4" x 2 9/32", White	144/cs.

D. STERNO® BRAND CRYSTALYTE® LIQUID WAX CARTRIDGE STERNO

Liquid wax cartridges make it easier, safer and more economical to create ambiance with table lamps. They are virtually odorless, has a bright clean burn and comes in a variety of burn times.

25080837	<i>837</i>	36 hr., 3"	36/cs.
-----------------	------------	------------	--------

FUEL



E. HANDY FUEL® CANNED HEAT™ COOKING FUEL STERNO

High heat output of a methanol gel for food applications. Consistent delivery for the promised burn-time. Versatile enough to use with a broad range of equipment.

25083008	<i>HF03008</i>	2 hr.	72/cs.
-----------------	----------------	-------	--------

F. STERNO® GEL CHAFING FUEL STERNO

Maximum heat output of a gel for food applications. Consistent delivery for the promised burn-time. Safe, non-toxic ethanol formulation. Even when the lids come off in a typical serving environment, Sterno Brand gel will reach and maintain the FDA minimum food holding temperature of 140°F. Versatile enough to use with a broad range of equipment.

25084008	<i>ST04008</i>	2 hr. Smart Can™	72/cs.
-----------------	----------------	------------------	--------

G. STERNO® WICK CHAFING FUEL STERNO

High heat output for beverage service and other applications. Versatile enough to use with a broad range of equipment. Consistent delivery. Safe. Cool to the touch. Spill proof can with a visible flame.

25083009	<i>ST03009</i>	6 hr.	24/cs.
-----------------	----------------	-------	--------

COFFEE



H. FOLGERS® PROCTER & GAMBLE

Coffee Filter Packs

Filter packs are the ultra convenient way to make your coffee in the morning. No fuss, no mess. Perfect for the office breakroom.

16907441	<i>06136</i>	0.9 oz., Decaf	80/cs.
16904192	<i>06114</i>	0.9 oz., Regular	160/cs.

Coffee/Coffee Filters/Scraper/Food Pan



A. FOLGERS® (CONT.) PROCTER & GAMBLE

Decaffeinated Coffee

Satisfies decaffeinated coffee lovers. Patented fast decaffeination process delivers rich flavor which is virtually indistinguishable from regular Folgers. Natural decaffeination removes 99.7% of caffeine without unnatural chemicals.

16906925	06926	0.8 oz., Ultra Roast	42/cs.
16906927	06927	0.9 oz., Ultra Roast	42/cs.

Regular Coffee

Rich, smoother tasting Mountain Grown® flavor and aroma. Quality coffee served in more American homes than any other brand. Holds its flavor freshness longer than all competitive foodservice coffees.

16906929	06929	0.8 oz., Ultra Roast	42/cs.
16906930	06930	0.9 oz.	42/cs.
16900042	00367	33.9 oz.	6/cs.
16903973	84943973	1.05 oz.	42/cs.



B. MILLSTONE® REGULAR COFFEE PROCTER & GAMBLE

Delicate aroma, smooth clean flavor. Our lightest roast coffee, Breakfast Blend is a subtle introduction to the world of gourmet Millstone Coffee. You'll enjoy the delicate top notes and bright floral, almost tea-like finish...it's a perfect drink for any time of day.

16901046	00283	1.75 oz., Breakfast Blend	40/cs.
----------	-------	---------------------------	--------

Hand-picked from Colombia's mountain ranges, this classic coffee is distinguished by its full body and rich flavor.

16903673	64102	1.75 oz., Columbian Supremo	40/cs.
----------	-------	-----------------------------	--------



COFFEE FILTERS

C. BUNN® COFFEE FILTERS BUNN-O-MATIC

Filters

Filter for Bunn® Iced Tea Brewers, Bunn System II®, DUAL and DUAL Coffee Brewers and 1½ gallon urns. (250) per bag, (2) bags per case, (25) per cluster.

11400139	201380000	13¾" x 5¼"	504/cs.
----------	-----------	------------	---------

Naturally Biodegradable

Naturally biodegradable. Made from 100% pure virgin fiber. 100% oxygen processed and chlorine free. (250) per case, (25) per cluster.

11406100	201090000	For 3 gal. Urns, 17½" x 7", U3 Narrow Base	250/cs.
----------	-----------	--	---------

Paper Filters

11406000	201150000	For 12 Cup Brewers, 4¼" Base, Regular	1000/cs.
----------	-----------	---------------------------------------	----------

11407600	201110000	For 6 gal. Urns, 20" x 8"	250/cs.
----------	-----------	---------------------------	---------

SYS3 Filters

SYS3 filters for the Bunn system III®. Naturally biodegradable. Made from 100% pure virgin fiber. 100% oxygen processed and chlorine free. (250) per bag, (2) bags per case, and (25) filters per cluster.

11402012	201200000	14¾" x 5", Paper	500/cs.
----------	-----------	------------------	---------



SCRAPER

D. SCRAPER RUBBERMAID

Traditional flat blades for scraping and spoon-shaped blades for easy spooning, scooping and spreading. Blades molded onto handles for permanent bond. Seamless construction resists dirt or bacteria build up. Dishwasher safe.

177019051	1905	13½", White	1/ea.
-----------	------	-------------	-------



FOOD PAN

E. COLD FOOD PAN CCP

Meet Gastronorm specification EN631-1. Impact and chemical resistant. Temperature range from -40°F to 212°F.

27600411	9610	12¼" x 10½" x 2½", Clear	5/cs.
----------	------	--------------------------	-------



Ingredient Bins/Grease Filters/holders/High Chair



INGREDIENT BINS

A. MOBILE INGREDIENT BINS CCP

Two section tilt and slide lid is designed for easy access. Unique lid design helps to prevent cross-contamination. Non-marking wide track 3" casters, two fixed and two swivel for finger tip maneuverability. Rear lid tab prevents lid breakage. Sized to fit under standard counters.

27609321	9321	21 gal., White w/Clear Lid	1/ea.
27609326	9326	26 gal., White w/Clear Lid	1/ea.



B. PROSAVE™ MOBILE INGREDIENT BIN RUBBERMAID

Patent-pending one handed access and integrated measuring tool increases preparation efficiency. Rectangular design improves space optimization under a preparation table or in a storeroom. Integrated sliding lid for one handed access. Clear door for quick identification of ingredients. Integrated scoop and storage for food code compliance. All certified to NSF Std. #2. Casters allow ingredient bins to be transported.

17700017	360088	124 lb., 29 1/4" x 13 1/8" x 28"H, White	1/ea.
-----------------	--------	--	-------



C. PROSAVE™ SHELF INGREDIENT BIN RUBBERMAID

Quick one handed access while stacked and integrated measuring tool increases preparation efficiency, space optimization and promotes food safety compliance. The lid design provides access to ingredients while stacked. Clear windows and ingredient labels for easy identification of contents. Integrated two cup safety portioning scoop and hook provide dedicated scoop storage for safe ingredient portioning. Assists in complying with FDA Food Code 3-304.12. FIFO (First In, First Out) barrier aids in proper rotation of ingredients.

17705558	9G58	10.7 gal.	1/ea.
-----------------	------	-----------	-------



GREASE FILTERS/HOLDERS

D. FILTER CONE HOLDER CCP

Manual filter cone holder.

27600781	FCH101	10"D	1/ea.
-----------------	--------	------	-------



E. SHORTENING FILTERS CCP

Automatic filters. Envelope.

27600757	D1113E4	Belshaw, 11" x 13", 7/8" Hole 2 Sides	100/cs.
27600794	D1320E3	BKI, 13 1/2" x 20 1/2", 1 1/4" Hole 1 Side	100/cs.
27604223	D1422E3	Henny Penny, 14" x 22", 1 1/2" Hole 1 Side	100/cs.



F. SHORTENING FILTERS CCP

Regular cone manual shortening filters.

27600799	FC100	10"	500/cs.
27600772	FC103	10"	500/cs.



HIGH CHAIR

G. STURDY CHAIR™ YOUTH SEAT RUBBERMAID

Microban® antimicrobial protection helps prevent the growth of stain and odor causing bacteria. Attractive, contemporary styling and easy to clean durability help keep dining areas pleasant. Available with and without wheels and both feature a convenient handle for easy maneuverability. Easy-to-use tray that can be removed with one hand. Colorful trays are optional and fit both wheeled and stationary chairs. Meets the latest ASTM 404-99 safety standards. Black, platinum, or dark green.

17707802	7806	23 1/2"L x 23 1/2"W x 29 3/4"H, w/o Wheels	1/ea.
-----------------	------	--	-------

Beverage & Dispenser Napkins

BEVERAGE NAPKINS

A. BEVERAGE NAPKINS

PRIME SOURCE®

High quality, value priced napkin ideal for all public environments.

75004380	75004380	4 ⁷ / ₁₀ " x 4 ⁷ / ₁₀ ", 1-Ply	4/1000/cs.
75004381	75004381	4 ⁷ / ₁₀ " x 4 ⁷ / ₁₀ ", 1-Ply	8/500/cs.

Hi-Valu

High quality napkins are value priced. Ideal for all public environments.

73004380	73004380	9" x 9", 1/4-Fold, 1-Ply	4000/cs.
----------	----------	--------------------------	----------

B. BEVERAGE NAPKINS

HOFFMASTER

Two-ply paper beverage napkin.

17801065	056246	10" x 10", White	3000/cs.
----------	--------	------------------	----------

Decorator Beverage Napkins

Decorative inner packs are completely overwrapped in poly to keep napkins clean and sanitary. The decorative sleeves also perfect for catering events. Oak leaf embossed.

17800081	020389	10" x 10", Black, 2-Ply	1000/cs.
17800074	020393	10" x 10", Burgundy, 2-Ply	1000/cs.
17800079	020390	10" x 10", Ecru, 2-Ply	1000/cs.

C. BEVERAGE NAPKINS

MARCAL PAPER MILLS

The poly wrap pack is a big space saver and keeps the product dry while working. Whitened without chlorine bleaching. Hypoallergenic. Virtually lint free. No dye or fragrance.

15700028	0028	500 ct., 9 ¹ / ₄ " x 9 ¹ / ₂ ", 1-Ply	4000/cs.
----------	------	---	----------

D. TORK® BEVERAGE NAPKINS

SCA TISSUE

Tork® Advanced Beverage Napkins

Two-ply and facial grade provides a superior look and feel to other beverage napkins. Box packaging ensures perfect product quality and protection. Disposal is simple and convenient. Napkins are always fresh and sanitary. Made from 100% recycled fiber. EcoLogo™ Certified. Folded size: 5" x 5".

14101241	B1241	300 ct., 10" x 10", 1/4 Fold, White, 2-Ply	3000/cs.
----------	-------	--	----------

Tork® Universal Beverage Napkins

Embossed semi-crepe texture gives a higher-quality feel. Economical napkin is perfect for high-volume applications. Made from 100% recycled fiber. EcoLogo™ Certified. 1/4 fold.

Folded size: 4²/₃" x 4²/₃".

14101143	B1141A	1000 ct., 9 ³ / ₈ " x 9 ³ / ₈ ", White, 1-Ply	8/500/cs.
14101141	B1141	1000 ct., 9 ³ / ₈ " x 9 ³ / ₈ ", White, 1-Ply	4/1000/cs.

DISPENSER/LUNCHEON NAPKINS

E. DISPENSER NAPKINS

PRIME SOURCE®

Green Source™ Dispenser Napkins

100% recycled. Chlorine-free. EcoLogo™ Certified. Trilingual packaging (English, Spanish, French). White.

75009550	75009550	Low Fold, 1-Ply	6000/cs.
75009545	75009545	Tall Fold, 1-Ply	7500/cs.

Hi-Valu

High quality napkins are value priced. Ideal for all public environments. White.

73004383	73004383	7" x 13", Tall Fold	8000/cs.
73004384	73004384	7" x 13", Tall Fold	8000/cs.
73002654	73002654	11 ¹ / ₈ " x 7", Low Fold, 1-Ply	10000/cs.
73004385	73004385	11 ¹ / ₄ " x 13", 1/4 Fold	6000/cs.

Dispenser Napkins

High quality, value priced napkins offer absorbency, strength and cleanliness. White.

76002654	76002654	6 ¹ / ₂ " x 12", Low Fold, 1-Ply	8000/cs.
75004379	75004379	6" x 13 ¹ / ₂ ", Tall Fold, 1-Ply	10000/cs.
75004384	75004384	7" x 12", Tall Fold, 1-Ply	8000/cs.
75004383	75004383	7" x 12", Tall Fold, 1-Ply	10000/cs.
75004385	75004385	8 ⁷ / ₁₆ " x 12", Low Fold, 1-Ply	8000/cs.
75004387	75004387	12" x 13", Economy Fold, 1-Ply	6000/cs.
75004386	75004386	12" x 13", 1-Ply	6000/cs.



Dispenser/Luncheon Napkins



A. DISPENSER NAPKINS GEORGIA-PACIFIC

Acclaim® Low Fold
Small dispenser napkin for limited-menu service operations. Designed to be used with TidyNap® low fold table and cafeteria napkin dispensers. Folded size: 3½" x 5".
13707925 39201 250 ct., 9" x 12", White, 1-Ply 8000/cs.

Acclaim® Mini-Mornap®
Economical, mini full-fold large dispenser napkin solution for all quick-service operations. Folded size: 3¾" x 6½".
13703822 37000 500 ct., 12" x 13", White, 1-Ply 6000/cs.

Acclaim® Tall Fold
Economy single-ply HyNap® tall fold dispenser napkins are a low cost small dispenser napkin for limited-menu service restaurants. Designed to be used with HyNap® tall fold, open-faced napkin dispensers. Folded size: 3½" x 6¾".
13707930 33201 250 ct., 7" x 13½", White, 1-Ply 10000/cs.

EasyNap®
Embossed multi-layer napkins for the EasyNap® high capacity system. One-at-a-time napkin dispensing reduces napkin usage by up to 30% and improves operational efficiency with fewer refills, reduced run-out risk, and less required storage space.
13703220 32002 250 ct., 6½" x 10", White, 1-Ply 24/cs.

MorNap®
Full fold, large dispenser napkins provide a solution for all quick-service operations. Designed to fit high-capacity MorNap® dispensers. Folded size: 5" x 6½".
13707402 37402 500 ct., 12" x 17", White, 1-Ply 6000/cs.

B. DISPENSER NAPKINS KIMBERLY-CLARK

Soft, absorbent, tall fold dispenser napkins with cross-hatched embossing.
15409871 98710 250 ct., 7" x 13½", White, 1-Ply 10000/cs.

Scott® Dispenser Napkins
Soft, absorbent, dispenser napkins.
15408720 98720 250 ct., 7" x 12", Tall Fold, White, 1-Ply 8000/cs.
15408730 98730 250 ct., 12" x 17", Full Fold, White, 1-Ply 6000/cs.

Scott® Megacartridge Napkins
The perfect solution to napkin overuse. One-at-a-time dispensing for reduced consumption. Easy loading and high capacity.
15409890 98908 875 ct., 6½" x 8½", White 5250/cs.

C. SMALL STEPS LUNCHEON NAPKINS MARCAL PAPER MILLS

Convenient Draw and Store® bag. 100% recycled. Whitened without chlorine bleaching. Hypoallergenic. Virtually lint free. No dye or fragrance. Poly bag.
15706507 6506 400 ct., 13" x 11¼", White, 1-Ply 2400/cs.

D. BOUNTY® EVERYDAY NAPKINS PROCTER & GAMBLE

Bounty quilted napkins provide you with the strength you've come to trust.
16904884 34884 12" x 12", White, 1-Ply 2000/cs.

E. DISPENSER NAPKINS SCA TISSUE

RollNap Dispenser Napkins
Contains 100% recycled fibers. Environmental Choice EcoLogo™ Certified. For use with 21GR and 21B dispensers.
14107049 DR7050 500 ct., 9" x 17", White, 1-Ply 6000/cs.

XpressNap® Dispenser Napkins
XpressNap® napkins are larger than major competitor interfolded napkins offering strength, absorbency and quality to users. Inner bag packaging. Contains 100% recycled fibers. EcoLogo™ Certified. One-ply.
14102900 DX900 500 ct., 8½" x 13", 4¼" x 6½" Folded, White 6000/cs.
14100901 DX906E 500 ct., 13" x 8½", 6½" x 4¼" Folded, Natural 6000/cs.

Dispenser/Luncheon/Dinner Napkins



A. TORK® DISPENSER NAPKINS SCA TISSUE

Tork® Advanced Dispenser Napkins - 1-Ply

Facial quality enhances feel and absorbency. Largest open and folded size dispenser napkin making it a good value, fewer napkins needed per serving. Bag packaging ensures superior product quality while protecting unused napkins. Made from 100% recycled fiber. Environmental Choice EcoLogo™ Certified.

14100826	D826E	Minifold, 500 ct., 13" x 12" Open, 6 1/2" x 3 3/4" Folded, Natural, Green Seal®	6000/cs.
14100820	D820	Luxri 13, 500 ct., 13" x 12" Open, 6 1/2" x 3 3/4" Folded, White,	6000/cs.
14100806	D806E	Luxri 17, 500 ct., 12" x 17" Open, 5" x 6 1/2" Folded, Natural, Green Seal®	6000/cs.
14101802	D802A	Luxri 17, 500 ct., 12" x 17" Open, 5" x 6 1/2" Folded, White	6000/cs.

Tork® Universal Dispenser Napkins - 1-Ply

Facial quality enhances feel and absorbency more than usual single-ply service dispenser napkins. An SCA exclusive. Smaller opened size makes it an economical option, keeping costs down. Bag packaging ensures superior product quality while protecting unused napkins. Always fresh and sanitary. Napkins are made from 100% recycled fiber. EcoLogo™ Certified.

14106313	D6311A	Thrifty Daintifold, 334 ct., 5 1/2" x 12", 3 1/2" x 5" Folded, White	8016/cs.
14103058	D3056B	Betsy Tallfold, 625 ct., 6" x 13 1/2", 3 1/2" x 6 3/4" Folded, Natural	10000/cs.
14100191	D3052B	Betsy Tallfold, 625 ct., 6" x 13 1/2", 3 1/2" x 6 3/4" Folded, White	10000/cs.
14103060	D3061A	Daintifold Lowfold, 250 ct., 8 7/10" x 12", 3 1/2" x 5" Folded, White	8000/cs.
14103061	D3061	Daintifold Lowfold, 334 ct., 8 7/10" x 12", 3 1/2" x 5" Folded, White	8016/cs.
14100786	D786E	Masterfold, 500 ct., 13" x 12", 5" x 6 1/2" Folded, Natural	6000/cs.
14100780	D780	Masterfold, 500 ct., 13" x 12", 5" x 6 1/2" Folded, White	6000/cs.



B. TORK® UNIVERSAL WHITE LUNCHEON NAPKINS SCA TISSUE

Embossed semi-crepe texture provides a higher-quality feel and better absorbency. Perfect for food service operations serving light meals. Made from 100% recycled fiber. EcoLogo™ Certified. Folded size: 6 1/2" x 5 3/4".

14103141	L3141	500 ct., 13" x 11 1/2", 1/4 Fold, White, 1-Ply	6000/cs.
----------	-------	--	----------



DINNER NAPKINS

C. DINNER NAPKINS PRIME SOURCE®

Green Source™ Dinner Napkins

100% recycled. Chlorine-free. EcoLogo™ Certified. Trilingual packaging (English, Spanish, French). White.

75009540	75009540	15" x 17", 1/8 Fold, 2-Ply	2600/cs.
----------	----------	----------------------------	----------

Hi-Valu

High quality napkins are value priced. Ideal for all public environments. White.

73004390	73004390	15" x 17", 1/8 Fold, 2-Ply	3000/cs.
73004391	73004391	15" x 17", 1/8 Fold, 2-Ply, Embossed	3000/cs.
73004392	73004392	15" x 17", 1/8 Straight, 2-Ply, Embossed	3000/cs.
73004393	73004393	15" x 17", 1/8 Fold, Side-by-Side, 2-Ply	3000/cs.
73004394	73004394	17" x 17", 1/8 Straight, 2-Ply, Embossed	3000/cs.
73004395	73004395	17" x 17", 1/4 Vertical, 1-Ply, Embossed	4000/cs.
73004397	73004397	15" x 17", 1/8 Fold, 1-Ply	5000/cs.

Dinner Napkins

High quality, value priced napkins offer absorbency, strength and cleanliness. White.

75004303	75004303	15" x 16 1/4", 1/8 Fold, 2-Ply	3000/cs.
75004388	75004388	15" x 17", 1/8 Fold, 1-Ply	3000/cs.
75004389	75004389	15" x 17", 1-Ply	5000/cs.
75004390	75004390	15" x 17", 2-Ply	3000/cs.



Dinner Napkins



A. DINNER NAPKINS GEORGIA-PACIFIC

Crown® Dinner Napkins

Economical dinner napkins for value-oriented full-service restaurants.

13701578 31578 150 ct., 15" x 17", 1/8 Fold, White, 1-Ply 3000/cs.

Essence® Dinner Napkins

Fine paper linen napkins offer the ultimate linen replacement at a fraction of the cost.

13700134 92117 100 ct., 17" x 17", 1/8 Fold, White 400/cs.



B. DINNER NAPKINS HOFFMASTER

Decorator Dinner Napkins

Embossed, 1/8 fold dinner napkins.

17800722 020524 15" x 17", Burgundy, 2-Ply, Oak Leaf Emboss 1000/cs.

17801598 020517 15" x 17", Ecu, 2-Ply, Oak Leaf Emboss 1000/cs.

17800047 010047 17" x 17", White, 3-Ply, Greek Key Emboss 600/cs.

Linen-Like® Dinner Napkins

A high quality, convenient replacement for linen. One napkin lasts an entire meal.

17805023 125023 16" x 16", White, Flat Pack 1000/cs.

17800202 120051 17" x 17", White 300/cs.



C. SCOTT® DINNER NAPKINS KIMBERLY-CLARK

Strong and economical napkins perfect for business or home.

15408171 98171 250 ct., 17" x 17", White, 1/4 Fold 4000/cs.

15408200 98200 300 ct., 15" x 17", White, 2-Ply 3000/cs.

15409838 98380 200 ct., 17" x 17", White, 3-Ply 2000/cs.



D. BELLA® DINNER NAPKINS MARCAL PAPER MILLS

This premium dinner napkin brings a tradition of quality to the table. Bella's 1/8-fold, two-ply napkins are designed to suit any occasion. A handy Snap-pac® packing feature makes dispensing quick, easy and convenient. Whitened without chlorine bleaching. Hypoallergenic. Virtually lint free. No dye or fragrance. Corrugated carton.

15700021 0021 100 ct., 15" x 17", White, 2-Ply 3000/cs.

E. TORK® DINNER NAPKINS SCA TISSUE

Tork® Advanced Dinner Napkins - 2-Ply

Exclusive tall fold styling allows silverware to rest on it with little or no overhang. Bag packaging ensures superior product quality while protecting unused napkins. Napkins are always fresh and sanitary. Made from 100% recycled fiber, it offers environmental benefits and is a positive image builder. EcoLogo™ Certified. White.

14102000 NP310A 375 ct., 15" x 16 1/4", 3 3/4" x 8 1/8" Folded, 1/8 Fold 3000/cs.

14101528 NP528PA 100 ct., 15" x 17", 3 3/4" x 8 1/2" Folded, 1/8 Fold 2800/cs.

14100526 NP528PA 100 ct., 15" x 17", 3 3/4" x 8 1/2" Folded, 1/8 Fold 3000/cs.

Tork® Advanced Sea Shell Dinner Napkins - 2-Ply

The Sea Shell embossing and facial quality two-ply brings class and practicality to casual dining. High brightness provides a quality look. Quarter fold design offers quick and easy wrapping of cutlery. Made from 100% recycled fiber. Replaces NP5240 and NP5240A. Environmental Choice EcoLogo™ Certified. White.

14105241 NP5240C 375 ct., 15" x 16 1/4", 7 1/2" x 8 1/8" Folded, 1/4 Fold 3000/cs.

Tork® Advanced Embossed Dinner Napkins - 3-Ply

This embossed, facial quality, three-ply napkin has advantages over cloth: absorbency, never frayed, uniform presentation, cleanliness and especially cost savings. The tasteful rose embossing combined with three-ply thickness and high brightness provides for a quality look and hand feel. Made from 100% recycled fiber. Replaces NP7340. EcoLogo™ Certified. White.

14107340 NP7340A 250 ct., 17" x 16 1/8", 8 1/2" x 8 1/8" Folded, 1/4 Fold 2000/cs.

14102001 NP7380A 290 ct., 17" x 16 1/8", 4 1/4" x 8" Folded, 1/8 Fold 1740/cs.

Tork® Universal Dinner Napkins - 1-Ply

Embossed semi-crepe texture. Inexpensive alternative to multi-ply facial. Perfect for high-volume applications. Made from 100% recycled fiber. EcoLogo™ Certified. White.

14102003 N5183A 500 ct., 15" x 16 1/4", 3 3/4" x 8 1/8" Folded, 1/8 Fold 2000/cs.

14102006 N5181A 250 ct., 15" x 17", 3 3/4" x 8 1/2" Folded, 1/8 Fold 3000/cs.

14105140 N5140A 334 ct., 15" x 17", 7 1/2" x 8 1/2" Folded, 1/4 Fold 3000/cs.

14105142 N5140A 334 ct., 15" x 17", 7 1/2" x 8 1/2" Folded, 1/4 Fold 4008/cs.

14107142 N7141A 334 ct., 17" x 17", 8 1/2" x 8 1/2" Folded, 1/4 Fold 4008/cs.

Napkin Band/Napkin Dispensers/Placemats

NAPKIN BAND

A. NAPKIN BAND SMITH LEE

Paper napkin band.

18104500 154500 1 1/2" x 4 1/2", White 20000/cs.

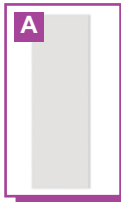

NAPKIN DISPENSERS

B. TALL-FOLD TABLETOP NAPKIN DISPENSERS SAN JAMAR

Easy loading, two-sided tall fold dispenser. Design allows visibility of printed napkin logo.

Holds up to 150 napkins

62578001 H900BK 150 Napkins, 7 1/2" x 3 3/4" x 4", Black 1/ea.

62579011 H900X 150 Napkins, 7 1/2" x 3 3/4" x 4", Stainless Steel 12/cs.



C. TORK® XPRESSNAP® NAPKIN DISPENSERS SCA TISSUE

Tabletop Napkin Dispenser

Increase hygiene and cut waste by delivering one napkin at a time. Customers touch only the napkins they take and take only what they use. AD-a-Glance message panels that can be used for in-store promotions or to generate ad revenue.

141000271 32XPT 200 Napkins, 6 1/5"H x 5 4/5"W x 7 4/5"D, Clear/Black 1/ea.

Stand Napkin Dispenser

XpressNap® greatly increases personal hygiene and cuts waste by delivering one napkin at a time, every time. SCA Tissue guarantees a 25% reduction in napkin usage although actual results often show savings as high as 40%. The XpressNap® Stand model provides stability and holds the dispenser upright. Its portable feature allows the user to easily position the unit at any location. The unique AD-a-Glance message panel can be used for in-store promotions or to generate advertising revenue. First introduced in 2004, the XpressNap system has taken the foodservice industry by storm and has earned international recognition for innovation and excellence. ABS plastic.

14100035 32XPS 900 Napkins, 19 1/2"H x 8"W x 5 4/5"D, Clear/Black 1/ea.



PLACEMATS

D. ECO DECORATOR PLACEMATS HOFFMASTER

100% recycled paper placemats.

Scalloped Edge

17809525 310524 9 3/4" x 13 1/2", Burgundy 1000/cs.

17800795 310525 9 3/4" x 13 1/2", Dusty Rose 1000/cs.

17809981 310526 9 3/4" x 13 1/2", Jade 1000/cs.

17800523 310523 9 3/4" x 13 1/2", Navy Blue 1000/cs.

17805175 310521 9 3/4" x 13 1/2", Red 1000/cs.

Straight Edge

17809468 310468 9 3/4" x 13 1/2", White 1000/cs.



Placemats/Tray Cover/Tablecovers



A. DECORATOR PLACEMAT **HOFFMASTER**
 Tiffany die cut bond placemat.
17809024 309024 9³/₄" x 14", Burgundy 1000/cs.



B. EMBOSSED PLACEMAT **SMITH LEE**
 Straight edge placemat.
18107950 30659 10" x 14", White 1000/cs.



C. EMBOSSED TRAY COVER **SMITH LEE**
 Anniversary embossed tray cover with scalloped edges.
18107044 8704471 13³/₄" x 16⁵/₈", White 1000/cs.



D. TABLECOVER ROLL **PRIME SOURCE®**
 Embossed plastic tablecover in a roll.
76000075 76000075 40" x 300', White 1/rl.



E. TABLECOVER ROLL **HOFFMASTER**
 One-ply paper roll tablecover.
17800043 260045 40" x 300', Bright White 1/rl.



F. CELLUTEX® DECORATOR TABLECOVERS **HOFFMASTER**
 Two-ply tissue, one-ply poly tablecovers.
17805465 210046 54" x 54", Dinner, White 50/cs.
17801083 220622 54" x 108", Banquet, Navy Blue 25/cs.
17801087 220611 54" x 108", Banquet, Red 25/cs.
17801086 210130 54" x 108", Dinner, White 25/cs.



G. TORK® PREMIUM FOLDED TABLECOVER **SCA TISSUE**
 Tork® Premium folded tablecovers have a sturdy poly backing that protects from spills. Soft two-ply tissue delivers the softness and drape of cloth. Disposable for quick and easy cleanup that helps reduce costs.
14100529 540TW 54" x 108", White, 3-Ply, Key Emboss 20/cs.

TRAY COVER

TABLECOVERS

Caterware



CATERWARE

A. CATERWARE® CATERBOWL® SERVING BOWLS/LIDS PACTIV

Disposable serving bowls with plastic dome covers.

16209020	92220K	5 lb., 12 ¹ / ₈ " x 2 ¹ / ₄ ", Black	25/cs.
16209030	92230K	10 lb., 14 ³ / ₈ " x 2 ⁵ / ₇ ", Black	25/cs.
16209021	P92220	Dome Lid Fits 5 lb., Clear	25/cs.
16209031	P92230	Dome Lid Fits 10 lb., Clear	25/cs.



B. CATERLINE® PACK N' SERVE PET BOWLS/LIDS WNA COMET

Ease the transition from preparation to presentation. Subtle fluting on bowl and lid enhances the packaging appearance and food presentation. Unique stacking system (bowl into lid) allows nesting for stability during transport. Each bowl nests into the lid of the same size and the lid of the next larger size. Strategically designed sidewall offers superior strength and a dramatic look.

12202758	APB80BL	80 oz., Black	25/cs.
12202759	APB160BL	160 oz., Black	25/cs.
12202786	APB80DM	Lid Fits APB80 Bowl, Clear	25/cs.
12202785	APB160DM	Lid Fits APB160 Bowl, Clear	25/cs.



C. HEXQUISITE™ CATERING BOWL PACTIV

Disposable serving bowl with clear plastic dome cover.

16206502	966512KWP	5 lb., 12", Black/Clear	25/cs.
----------	-----------	-------------------------	--------



D. CATERWARE® CATERMATE® SERVING UTENSILS PACTIV

Gloss black plastic serving utensils.

16209006	9006K	Spoon, 9" x 2", Black	100/cs.
16209005	9005K	Fork, 9" x 2", Black	100/cs.
16209007	9007K	Tongs, 7", Black	100/cs.



E. PRIME SOURCE® ALUMINUM PARTY TRAYS PRIME SOURCE®

Flat aluminum trays. Embossed. Sturdy construction and nesting design for stacking.

75003731	75003731	12" dia.	25/cs.
75003733	75003733	12" dia., 5-Compt. Lazy Susan	25/cs.
75003737	75003737	16" dia.	25/cs.
75003739	75003739	16" dia., 5-Compt. Lazy Susan	25/cs.
75003750	75003750	18" dia., 6-Compt. Lazy Susan	25/cs.



F. CATERWARE® DELUXE EMBOSSED FLAT TRAYS PACTIV

Deluxe embossed aluminum flat trays.

16208221	451212A	12" dia.	50/cs.
16208240	451612A	16" dia.	50/cs.
16208209	441610A	16" dia., 5-Compt. Lazy Susan	50/cs.
16208254	451812A	18" dia.	50/cs.



G. REYNOLDS® CATER-TIME® FLAT TRAYS/LID REYNOLDS® FOOD PACKAGING

Make food preparation, transport, service and clean-up more efficient. Everything from appetizers through sandwiches and main courses, all the way to desserts can be displayed attractively on embossed heavy gauge aluminum trays. Convenient tab closure on our lids makes closing, opening and reclosing a snap.

17308008	RC012F	12" dia. x 9/16"H, Plain, .008	25/cs.
17308011	RC016F	16" dia. x 5/8"H, Plain, .009	25/cs.
17308013	RC018F	18" dia. x 11/16"H, Plain, .010	25/cs.
17303614	13614	Dome Lid Fits 16" Tray	25/cs.



Caterware/Hinged Paper Containers



CONTAINERS & TRAYS

A. CATERWARE® TRAYS/LID PACTIV

Trays with Rosedome dome lids.

16203500	NLP12LB350R	12" dia. Lazy Susan Base, 3 1/2" H Dome	25/cs.
16200237	NLP16B400R	16" dia. Lazy Susan Base, 4" H Dome	25/cs.
16202240	NLP16FB400R	16" dia. Flat Base, 4" H Dome	25/cs.
16200235	NLP18B450R	18" dia. Lazy Susan Base, 4 1/2" Dome	25/cs.
16204618	P4418Z	Dome Lid Fits 18" Tray	50/cs.

B. SMARTLOCK® CATERWARE® TRAYS/LIDS PACTIV

SmartLock® closure is an easy way to secure dome to tray. Secure nesting design keeps trays stacked and prevents shifting. Thumb tab enables quick and easy opening.

16209812	9812K	12" dia.	50/cs.
16206912	9912K	12" dia., 6-Compt. Lazy Susan	50/cs.
16206913	9816K	16" dia.	50/cs.
16206914	9818K	18" dia.	50/cs.
16206905	P9812	Dome Lid Fits 12"	50/cs.
16206906	P9816	Dome Lid Fits 16"	50/cs.
16206904	P9818	Dome Lid Fits 18"	50/cs.

C. ROSEDOME™ CATERWARE® CATERTRAY COMBO PACTIV

APET plastic construction. 2 1/4" RoseDome™ lid with 12" lazy susan black base.

16200245	NLP12B225R50	12" dia., Black/Clear	50/cs.
----------	--------------	-----------------------	--------

D. SMARTLOCK® CATERWARE® SCALLOP RIM TRAY COMBOS PACTIV

In convenient combo packs, Pactiv SmartLock® Caterware® Trays are designed to nest and stack. The SmartLock® Closure makes these trays easy to open and close, and the lid remains attached even if cracking occurs.

16209813	9812KWP	12" dia., Black/Clear	25/cs.
16206916	9818KWP	18" dia., Black/Clear	25/cs.

HINGED PAPER CONTAINERS

E. HINGED TAKEOUT CONTAINERS BRIDGE-GATE ALLIANCE GROUP

Premium hingeware made from renewable resources. Biodegradable and compostable. FDA approved for food use. Grease and water resistant. Microwaveable. BPI certified.

B7280100	BG6HW	6"	500/cs.
B7280101	BG8HW	8"	200/cs.
B7280102	BG83HW	8", 3-Compt.	200/cs.
B7280103	BG9HW	9"	200/cs.
B7280104	BG93HW	9", 3-Compt.	200/cs.
B7280105	BG10HW	10"	200/cs.
B7280106	BG103HW	10", 3-Compt.	200/cs.
B7280107	BGHOAGIE	19.69" x 11.42" x 10.04", Hoagie	250/cs.

F. HINGED TAKEOUT CONTAINERS BRIDGE-GATE ALLIANCE GROUP

Economy hingeware made from renewable resources. Biodegradable and compostable. FDA approved for food use. Grease and water resistant. Microwaveable. BPI certified.

B7280200	ECO6HW	6"	4/100/cs.
B7280201	ECO8HW	8"	2/100/cs.
B7280202	ECO83HW	8", 3-Compt.	2/100/cs.
B7280203	ECO9HW	9"	2/100/cs.
B7280204	ECO93HW	9", 3-Compt.	2/100/cs.
B7280205	ECOHOAGIE	9" x 5" x 3", Hoagie	2/125/cs.
B7280022	ECOHOAGIE2	9" x 5" x 3", 2-Compt. Hoagie	2/125/cs.

G. HARVEST COLLECTION™ HINGED CONTAINERS GENPAK

Compostable dinnerware for foodservice applications. Produced from environmentally friendly, annually renewable resources.

34789246	HCH80	8" x 8" x 2 1/2", Harvest Tan	200/cs.
34789236	HCH83	8" x 8" x 2 1/2", 3-Compt., Harvest Tan	200/cs.

Hinged & Non-Hinged Paper Containers



A. NATURE FRIENDLY® CLAMSHELL CONTAINERS

NATURE FRIENDLY PRODUCTS

Nature Friendly Products' 100% biodegradable and compostable tableware provides consumers with an eco-friendly alternative to traditional disposables. Made from sugar cane bagasse-based renewable resources, they are completely compostable within 50-100 days in home and commercial composting facilities. Superior in strength and performance. Non-toxic, hot/cold tolerant, oil and water resistant, microwave and freezer safe.

C6933003	<i>B003</i>	5" x 5", Hamburger	250/cs.
C6933004	<i>B024</i>	5" x 5", Hamburger	250/cs.
C6933011	<i>B1127</i>	6" x 6", Hamburger	500/cs.
C6933001	<i>B001</i>	7½" x 5", Lunch Box	250/cs.
C6933009	<i>B110</i>	8" x 8"	250/cs.
C6933012	<i>B118</i>	8" x 8", 3-Compt.	200/cs.
C6933002	<i>B002</i>	9" x 5½", 2-Partition Box	500/cs.
C6933007	<i>B025</i>	9" x 9"	200/cs.
C6933013	<i>B119</i>	10" x 10"	250/cs.
C6933010	<i>B111</i>	10" x 10", 3-Compt.	250/cs.



B. EARTHCHOICE® FIBER BLEND HINGED LID CONTAINERS PACTIV

Social responsibility, respect and care for the environment require action today while keeping an eye to the future. Meet the ASTM D 6868 Standards for Compostability. These products are made from sustainable, renewable materials. Made of a blend of fiber and pulp materials. Double tab lock keeps container securely closed. All natural white provides a brilliant, white exterior. Stackable. Soak through resistant design resists grease, moisture and helps eliminate messy leaks. Made in the USA.

16200422	<i>MCH0080</i>	6" x 6" x 2⅓", Sandwich 1-Compt.	500/cs.
16200357	<i>MCH0801</i>	8⅓" x 8⅓" x 2⅓", Medium 1-Compt.	200/cs.
16200355	<i>MCH0803</i>	8⅓" x 8⅓" x 2⅓", Medium 3-Compt.	200/cs.
16200359	<i>MCH0089</i>	9" x 6⅓" x 3", Utility 1-Compt.	200/cs.
16200353	<i>MCH0901</i>	9⅓" x 8¾" x 2½", Large 1-Compt.	200/cs.
16200352	<i>MCH0903</i>	9⅓" x 8¾" x 2½", Large 3-Compt.	200/cs.



NON-HINGED PAPER CONTAINERS

C. PRIME SOURCE® ENVY® PAPER FOOD CONTAINER COMBOS

PRIME SOURCE®

For all types of hot or cold foods. Extra-rigid, poly-lined inside and out. Sturdy, snug-fit spiral wound paper lids.

75002083	<i>75002083</i>	8 oz., w/Lid	250/cs.
75002085	<i>75002085</i>	12 oz., w/Lid	250/cs.
75002087	<i>75002087</i>	16 oz., w/Lid	250/cs.
75002089	<i>75002089</i>	32 oz., w/Lid	250/cs.



D. GOURMET FOOD CONTAINERS/LIDS

BRIDGE-GATE ALLIANCE GROUP

Compostable natural fiber takeout packaging. Made from 100% renewable resources. BPI Certified. Designed to disintegrate and biodegrade swiftly and safely in a professionally-managed composting facility.

Square/Rectangular

B7280028	<i>BGW8FC</i>	8 oz.	20/25/cs.
B7280027	<i>BGW12FC</i>	12 oz.	20/25/cs.
B7280026	<i>BGW16FC</i>	16 oz.	20/25/cs.
B7280048	<i>BGW32FC</i>	32 oz.	4/125/cs.
B7280025	<i>BGW816L</i>	Lid Fits 8-16 oz.	20/25/cs.
B7280049	<i>BGW32FCL</i>	Lid Fits 32 oz.	4/125/cs.

Oval

B7280046	<i>BGW24O</i>	24 oz.	3/100/cs.
B7280047	<i>BGW24OL</i>	Lid Fits 24 oz.	3/100/cs.



Non-Hinged Paper Containers



A. GOURMET OCTAGON CONTAINERS/LIDS

BRIDGE-GATE ALLIANCE GROUP

Compostable natural fiber takeout packaging. Made from 100% renewable resources. BPI Certified. Designed to disintegrate and biodegrade swiftly and safely in a professionally-managed composting facility.

B7280057	<i>BGW6OCT</i>	Base, Small	4/100/cs.
B7280059	<i>BGW8OCT</i>	Base, Medium	4/75/cs.
B7280063	<i>BGW10OCT</i>	Base, Large	4/75/cs.
B7280058	<i>BGW6OCTL</i>	Lid Fits Small	4/100/cs.
B7280062	<i>BGW8OCTL</i>	Lid Fits Medium	4/75/cs.
B7280064	<i>BGW10OCTL</i>	Lid Fits Large	4/50/cs.



B. GOURMET TAKEOUT CONTAINER

BRIDGE-GATE ALLIANCE GROUP

Compostable natural fiber takeout packaging. Made from 100% renewable resources. BPI Certified. Designed to disintegrate and biodegrade swiftly and safely in a professionally-managed composting facility.

B7280031	<i>BGW3</i>	#3, w/ Lid	200/200/cs.
-----------------	-------------	------------	-------------



C. FOOD CONTAINERS/LIDS

HUHTAMAKI

Paper food containers made with durable, double poly-coated paper. Strong and perfect for hot or cold foods.

Containers Only

15301037	<i>71037</i>	8-10 oz., White	1000/cs.
15300104	<i>71226</i>	12 oz., White	1000/cs.
15301091	<i>71091</i>	16 oz. Squat, White	500/cs.
15301840	<i>71840</i>	16 oz. Tall, White	1000/cs.
15300230	<i>60164</i>	64 oz., White	250/cs.

Combo Packs w/Vented Lids

15301839	<i>71842</i>	8-10 oz., White	250/cs.
15301838	<i>71843</i>	12 oz., White	250/cs.
15301837	<i>71844</i>	16 oz. Tall, White	250/cs.

Lids Only

15300063	<i>89107</i>	Vented Lid Fits 8/10/12/16 (Tall) oz. Cups	1000/cs.
15309112	<i>89112</i>	Vented Lid Fits 16/24/32 oz. Cups	500/cs.



D. STREETSIDE™ FOOD CONTAINERS

HUHTAMAKI

Paper food containers made with durable, double poly-coated paper. Strong and perfect for hot or cold foods.

15300278	<i>70310</i>	8-10 oz.	1000/cs.
15300266	<i>70316</i>	16 oz. Squat	500/cs.
15300281	<i>70416</i>	16 oz. Squat Combo Pack	250/cs.



E. ECOTAINER® FOOD CONTAINERS/LIDS

INTERNATIONAL PAPER

Made with fully renewable resources; fiber from sustainably managed forests and Ingeo™ a plant-based material (PLA). Meets Sustainable Forestry Initiative® (SFI®) Chain-of-Custody certification standards. Meets ASTM Standards for Compostability. Certified by the Biodegradable Products Institute (BPI). Performance is comparable to standard single-use paper disposables. Made in the USA.

14700332	<i>DFRE8</i>	8 oz.	1000/cs.
14703031	<i>DFRE12COMPASS</i>	12 oz., Compass	1000/cs.
14705016	<i>LFTFH16</i>	Vented Lid Fits 6/8/10/16 oz.	500/cs.
14700124	<i>LFRFH12</i>	Vented Lid Fits 12 oz.	1000/cs.

Non-Hinged Paper Containers



A. PRESSWARE® DUAL-OVENABLE TRAYS/LIDS PACTIV

Dual-ovenable paperboard trays can be used in microwave or conventional ovens at temperatures up to 400°F for up to 60 minutes. For hot and cold food applications. They can be stored in a freezer or refrigerator without cracking or denting, and are ideal for freezer to oven cooking applications. Made from 90% renewable resources.

Baker's Assurance®

16200560 PBA7106 23 oz., 7¹/₄" x 11⁵/₁₆" x 23/32" 500/cs.

Blue Country Classic™ - Blue Porcelain Exterior

16202614 PBC5613R 14¹/₂ oz., 4²⁷/₃₂" x 6¹⁷/₃₂" x 1³/₈" 1000/cs.

16202615 PBC5615 16³/₅ oz., 4²⁹/₃₂" x 6¹/₃₂" x 1¹¹/₁₆" 500/cs.

16200236 PBC6816 32 oz., 6" x 7⁷/₈" x 1³/₄" 500/cs.

16200625 PBC7014 45 oz., 7¹⁵/₃₂" x 9³¹/₃₂" x 1¹/₂" 250/cs.

Classic Stoneware™ - White w/Brown Specks

16204403 PCS4403 3¹/₂ oz., 4⁵/₁₆" x 4⁵/₁₆" x 3/8", Square 3000/cs.

16201106 PCS4412 5⁴/₅ oz., 4³/₁₆" x 4³/₁₆" x 1¹/₄", Square 1500/cs.

16200856 PCS0412 5⁷/₁₀ oz., 4³/₁₆" x 1¹/₄", Round 1000/cs.

16202540 PCS0511 7³/₅ oz., 5¹/₁₆" x 1¹/₈", Round 1000/cs.

16202541 PCS4707 9⁷/₁₀ oz., 4" x 7⁷/₁₆" x 7/8", Oblong 1000/cs.

16201053 PCS4413 9¹/₂ oz., 4³/₈" x 4³/₈" x 1³/₈", Square 1000/cs.

16201054 PCS0713H 12¹/₅ oz., 4⁷/₈" x 7⁷/₃₂" x 1³/₈", Oblong 1000/cs.

16200865 PCS4512 13 oz., 4⁷/₈" x 5¹⁵/₁₆" x 1¹/₄", Oblong 1000/cs.

16208501 PCS5611R 13⁴/₅ oz., 4²⁹/₃₂" x 6¹⁷/₃₂" x 1¹/₈", Oblong 1000/cs.

16208503 PCS5613RR1 14¹/₂ oz., 4²⁷/₃₂" x 6¹⁷/₃₂" x 1³/₈", Oblong 1000/cs.

16201119 PCS5613 14¹/₂ oz., 4³¹/₃₂" x 6¹/₁₆" x 1³/₈", Oblong 1000/cs.

16201123 PCS5710 15²/₅ oz., 5¹/₁₆" x 7¹³/₁₆" x 1", Oblong 500/cs.

16208502 PCS5615 16⁴/₅ oz., 4²⁹/₃₂" x 6³/₃₂" x 1¹¹/₁₆", Oblong 500/cs.

16205714 PCS5713 20⁴/₅ oz., 5¹/₁₆" x 7²⁵/₃₂" x 1³/₈", Oblong 250/cs.

16207342 PCS5811R 20¹/₂ oz., 5²⁹/₃₂" x 8⁹/₃₂" x 1¹/₈", Oblong 500/cs.

16202542 PCS5617 21 oz., 5" x 6¹/₂" x 1⁷/₈", Oblong 500/cs.

16200203 PCS5713R 21³/₁₀ oz., 5⁷/₁₆" x 7⁷/₁₆" x 1³/₈", Oblong 500/cs.

16207341 PCS6812R 27⁹/₁₀ oz., 6¹/₁₆" x 8²⁵/₃₂" x 1¹/₄", Oblong 500/cs.

16201057 PCS6816 32 oz., 6" x 7⁷/₈" x 1³/₄", Oblong 500/cs.

16201645 PCS6815 36⁷/₁₀ oz., 6¹⁹/₃₂" x 8³/₄" x 1⁵/₈", Oblong 250/cs.

16204646 PCS7014 45 oz., 7¹⁵/₃₂" x 9³¹/₃₂" x 1¹/₂", Oblong 250/cs.

16200251 PCS81116 64³/₁₀ oz., 8⁹/₁₆" x 11³¹/₃₂" x 1³/₄", Oblong 250/cs.

Ebony Premier® - Black

16200852 PEP4512 13 oz., 4⁷/₈" x 5²⁹/₃₂" x 1¹/₄" 1000/cs.

16200600 PEP5613R 14¹/₂ oz., 4²⁹/₃₂" x 6¹⁷/₃₂" x 1³/₈" 500/cs.

16201504 PEP5615 16⁴/₅ oz., 4¹⁵/₁₆" x 6⁵/₃₂" x 1¹¹/₁₆" 500/cs.

16200599 PEP5713R 21³/₁₀ oz., 5¹⁵/₃₂" x 7¹⁵/₃₂" x 1³/₈" 500/cs.

16201503 PEP6816 32 oz., 6¹/₃₂" x 7¹⁵/₁₆" x 1³/₄" 500/cs.

16209122 PEP6815 36⁷/₁₀ oz., 6⁹/₁₆" x 8³/₄" x 1⁵/₈" 250/cs.

16209121 PEP7014 45 oz., 7¹⁵/₃₂" x 9³¹/₃₂" x 1¹/₂" 250/cs.

OPS Dome Lids - Clear

16201118 CI85613 Fits 5613 1000/cs.

16200012 CI85613R Fits 5613R 1000/cs.

16200606 CI85615 Fits 5615 1000/cs.

16201125 CI85710 Fits 5710 500/cs.

16200848 CI85713 Fits 5713 250/cs.

16205712 CI85713R Fits 5713R 500/cs.

16208839 CI86816 Fits 6816 500/cs.

16200636 CI8D714 Fits 7014 250/cs.

16200549 CI80412 Fits PCS0412 1000/cs.

16200646 CI85611R Fits PCS5611R 1000/cs.

16200648 CI881116 Fits PCS81116 250/cs.



Non-Hinged Paper Containers



CONTAINERS & TRAYS



A. DOUBLE POLY PAPER FOOD CONTAINERS SOLO®

You can always count on Solo's very best paper containers. They are designed to meet any service or storage need you may have, including freezing and refrigerating. You can use them with a vented paper lid for soups and other hot foods. Or, for an economical choice, try one of our translucent plastic polypropylene lids.

18700983	<i>H41652050</i>	16 oz., White	500/cs.
18200771	<i>H43252050</i>	32 oz., White	500/cs.



B. FLEXSTYLE® COLD FOOD CONTAINERS/LIDS SOLO®

For all cold foods. Two-piece, heavy-duty paper construction. Heat-sealed side seams prevent leaks.

18704265	<i>P4165</i>	16 oz., White	500/cs.
18704633	<i>P432502050</i>	32 oz., White	500/cs.
18704648	<i>P464302050</i>	1/2 gal., White	300/cs.
18703494	<i>LW416</i>	Coverall Lid Fits 16 oz., White	500/cs.
18703498	<i>LW432</i>	Coverall Lid Fits 32 oz., White	500/cs.
18708064	<i>CA8A4000</i>	Non-Vented Paper Lid Fits 8 oz., White	500/cs.
18700714	<i>CA16A4000</i>	Non-Vented Paper Lid Fits 16 oz., White	500/cs.



C. FLEXSTYLE® HOT FOOD CONTAINER COMBOS SOLO®

You can always count on Solo's very best paper containers. They are designed to meet any service or storage need you may have, including freezing and refrigerating. You can use them with a vented paper lid for soups and other hot foods. Or, for an economical choice, try one of our translucent plastic polypropylene lids.

18202710	<i>KH12A02050</i>	12 oz., White	250/cs.
18700916	<i>KH16AW</i>	16 oz., White	250/cs.
18700932	<i>KH32A2050</i>	32 oz., White	250/cs.

D. HOT FOOD CONTAINER COMBOS SOLO®

Heavy-duty paper food container and lid.

18200484	<i>KH8W</i>	8 oz., Designer White	250/cs.
18200590	<i>KH16200</i>	16 oz., Designer White	250/cs.
18200290	<i>KH32200</i>	32 oz., Designer White	250/cs.



E. PAPER FOOD CONTAINERS/LIDS SOLO®

Using on-trend colors and a sophisticated pattern, we've created the ultimate look that will enhance every customer's dining experience. Whether you're looking for cups, dinnerware, or containers, Symphony's coordinating pieces offer the perfect single-use solution to complement every meal and beverage.

Single-Sided

18201170	<i>VS508J8000</i>	8 oz., Symphony™	1000/cs.
-----------------	-------------------	------------------	----------

Double-Sided

18201184	<i>KH8AJ8000</i>	8 oz. Combo, Symphony™	250/cs.
18201185	<i>H4125J8000</i>	12 oz., Symphony™	500/cs.
18201186	<i>KH12AJ8000</i>	12 oz. Combo, Symphony™	250/cs.
18201189	<i>H4165J8000</i>	16 oz., Symphony™	500/cs.
18201190	<i>KH16AJ8000</i>	16 oz. Combo, Symphony™	250/cs.
18201194	<i>KH32AJ8000</i>	32 oz. Combo, Symphony™	250/cs.

Lids

18700713	<i>CH8A4000</i>	Vented Paper Lid Fits H4085, H4125, White	500/cs.
18200831	<i>CH16A4000</i>	Vented Paper Lid Fits H4165, White	500/cs.



F. PAPER FOOD CONTAINERS SOLO®

Heavy-duty double poly paper food container.

18201388	<i>HD8</i>	8 oz., Designer White	500/cs.
18201412	<i>HD12</i>	12 oz., Designer White	500/cs.
18200303	<i>HD16</i>	16 oz., Designer White	500/cs.



Non-Hinged Paper & Hinged Plastic Containers



A. SINGLE POLY PAPER FOOD CONTAINER SOLO®

Try this reliable paper container in an attractive matched service design. It is perfect for just about any occasion and can be used for either hot and cold foods.

18705083 VS5082050 8 oz., White 1M/cs.



B. VS500 SERIES FOOD CONTAINER SOLO®

Affordable matte finish container. Polyethylene laminated inside; uncoated paper outside.

Suited for proportioning of hot and cold foods. Microwaveable. Uses lid # 8TFLD1.

18705082 VS506 6 oz., White 1000/cs.



HINGED PLASTIC CONTAINERS/CLAMSHELLS

C. CULINARY CLASSICS® MICROWAVEABLE CLAMSHELLS ANCHOR PACKAGING

Culinary Classics can withstand temperatures up to 230°F when used under heat lamps, in warming units, and in microwaves. The clear lid is designed with anti-fog technology, and is vented to allow steam to dissipate, keeping fried foods crisp and your product visible to assure order accuracy. Stacking will not block the vents. Secure snap closure ensures freshness and eliminates spills when transporting. The crack-resistant, cut-resistant polypropylene base allows your customers to eat right out of the container.

10809111 4659111 39 oz., 1-Compt. Base/Lid 100/cs.
 10809912 4669111 46½ oz., 1-Compt. Base/Lid 100/cs.
 10809611 4659611 47½ oz., 1-Compt. Base/Lid 100/cs.
 10809633 4659633 267/7 oz., 3-Compt. Base/Lid 100/cs.



D. DELI VIEW™ SANDWICH WEDGE ANCHOR PACKAGING

Hinged sandwich container with clear base and lid.

10800541 4511019 6⅝" x 3⅞" x 3⅞", Clear 250/cs.



E. MICRORAVES® HOT DOG CLAMSHELL ANCHOR PACKAGING

Clear microwavable polypropylene hinged container. For hot, fresh, and chilled foods.

10800349 4489409 7⅝" x 3⅝" x 1½", Clear 250/cs.



F. SHOWTIME® CLEAR HINGED CONTAINERS DART

Wide side ribbing allows easy viewing from all directions. Corner ribbing provides extra strength, helps avoid crushed containers. Designed to allow stacking of multiple containers.

Quick and easy snap-tight locking ensures safe handling.

12505710 C57HT1 6" x 5⅞" x 3¼", Small, Clear 500/cs.
 12505720 C90HT1 9" x 8" x 3¼", Medium, Clear 250/cs.



G. SECURE SEAL® HINGED DELI CONTAINERS GENPAK

Patented 360° seal allows for an air tight, leak resistant closure. Containers will not crack or dent in freezer applications. One piece construction eliminates lost lids. Will not break down due to oils from salads.

High Dome Lids

34785433 AD16F 16 oz., 5⅞" x 4½" x 3", Clear 200/cs.

34780114 AD32F 32 oz., 7¼" x 6⅞" x 3", Clear 200/cs.

Regular Lids

34780060 AD08 8 oz., 5⅞" x 4½" x 1½", Clear 200/cs.

34780054 AD12 12 oz., 5⅞" x 4½" x 2½", Clear 200/cs.

34780055 AD16 16 oz., 5⅞" x 4½" x 2⅝", Clear 200/cs.

34780058 AD24 24 oz., 7¼" x 6⅞" x 2¼", Clear 200/cs.

34780056 AD32 32 oz., 7¼" x 6⅞" x 2⅝", Clear 200/cs.

34780085 AD48 48 oz., 8⅞" x 8" x 2½", Clear 200/cs.

34780086 AD64 1/2 gal., 8⅞" x 8" x 3¼", Clear 200/cs.





Hinged Plastic Containers

CONTAINERS & TRAYS



A. SAFE-T-FRESH® HINGED DELI CONTAINERS INLINE PLASTICS

Our unique line of tamper resistant, tamper evident and leak resistant containers. These containers come with the built-in protection afforded by the Safe-T-Gard® Tear Strip Lock. This lock virtually assures that the container you've purchased hasn't been opened since the product was packed. The Safe-T-Gard® Tear Strip Lock is user friendly and, after removing it, the container stays intact and closes easily after you've enjoyed a portion of your favorite goodies. Perfect for fresh cut fruit, deli and bakery packaging.

Rectangular

39351008	<i>TS8</i>	8 oz., 4 ⁷ / ₈ " x 5 ¹ / ₂ " x 1 ⁹ / ₁₆ ", Clear	240/cs.
39350801	<i>TS12</i>	12 oz., 4 ⁷ / ₈ " x 5 ¹ / ₂ " x 2", Clear	240/cs.
39350800	<i>TS16</i>	16 oz., 4 ⁷ / ₈ " x 5 ¹ / ₂ " x 2 ⁵ / ₈ ", Clear	240/cs.
39350802	<i>TS24</i>	24 oz., 7 ³ / ₈ " x 5 ⁵ / ₈ " x 2 ⁵ / ₁₆ ", Clear	200/cs.
39350803	<i>TS32</i>	32 oz., 7 ³ / ₈ " x 5 ⁵ / ₈ " x 2 ³ / ₄ ", Clear	200/cs.
39350805	<i>TS48</i>	48 oz., 8 ³ / ₄ " x 7 ⁷ / ₈ " x 2 ⁵ / ₈ ", Clear	150/cs.
39350804	<i>TS64</i>	64 oz., 8 ³ / ₄ " x 7 ⁷ / ₈ " x 2 ³ / ₄ ", Clear	150/cs.

Round

39350056	<i>TS8R</i>	8 oz., 5 ⁷ / ₈ " x 5 ³ / ₄ " x 2", Clear	240/cs.
39351012	<i>TS12R</i>	12 oz., 5 ⁷ / ₈ " x 5 ³ / ₄ " x 2", Clear	240/cs.
39351016	<i>TS16R</i>	16 oz., 5 ⁷ / ₈ " x 5 ³ / ₄ " x 3 ¹ / ₈ ", Clear	240/cs.
39351024	<i>TS24R</i>	24 oz., 7" x 7" x 3 ¹ / ₈ ", Clear	150/cs.



B. SURE LOCK® HINGED CONTAINERS INLINE PLASTICS

Holds 1 lb. loaf cake, corn bread, 4" to 4¹/₂" cookies, hoagie.

39350945	<i>SLP35</i>	8 ⁷ / ₈ " x 5 ⁵ / ₁₆ " x 3 ³ / ₈ " OD	500/cs.
-----------------	--------------	---	---------

Holds cookies, tall lunch box, (2) half subs, small sub and chips, large salad.

39350057	<i>SLP40</i>	9 ³ / ₈ " x 6 ³ / ₄ " x 3 ¹ / ₁₆ "	276/cs.
-----------------	--------------	--	---------



C. VALU PACK® HINGED CONTAINERS INLINE PLASTICS

Crystal clear 100% recyclable PET. Ideal to promote commitment to environmentally responsible packaging. Automation friendly design. Easy to open; container and its contents will not be damaged while opening. Sure Lock® double line locks provide maximum security.

Stackable. Sanitary over lid design.

39350060	<i>VPP756</i>	33 ¹ / ₂ oz., Clear	500/cs.
39350071	<i>VPP747</i>	72 ¹ / ₅ oz., Clear	250/cs.
39350757	<i>VPP757</i>	82 ¹ / ₅ oz., Clear	250/cs.



D. DINNER BOXES INNOWARE PLASTICS

Convenient one-piece design. Microwarmable. Elegant black base. Crystal clear anti-fog lid, vented for moisture control. Stackable design. EZ closure.

12609192	<i>0919017</i>	64 oz., 1-Compt. Medium	100/cs.
12609195	<i>0919019</i>	32/10/10 oz., 3-Compt. Medium Micro	100/cs.



E. EXPRESSIONS® ECO™ HINGED CONTAINER INNOWARE PLASTICS

Made with environmentally friendly Ingeo™ plastic. Created from plants, not petroleum. ECO™ containers meet the ASTM Standards for Compostability as certified by the Biodegradable Products Institute. They biodegrade in a commercial compost facility within 60-180 days without releasing any toxic residues. Approved by Cedar Grove Composting, Inc., this innovative line of packaging is disposable with food waste - no separation is required!

12604050	<i>0854011</i>	9" x 3", Tan	200/cs.
-----------------	----------------	--------------	---------



F. OCTAVIEW® HINGED CONTAINERS INNOWARE PLASTICS

Convenient one-piece design. Elegant, black base. Crystal clear anti-fog lid. Stackable design. LeakGuard air-tight seal.

12600864	<i>0865611</i>	21 oz., 7 ¹ / ₂ " Medium, 1-Compt.	100/cs.
12605612	<i>0865612</i>	28 oz., 7 ¹ / ₂ " Deep, 1-Compt.	100/cs.
12600002	<i>0864611</i>	31 oz., 9" Shallow	100/cs.
12600863	<i>0864612</i>	42 oz., 9" Deep, 1-Compt.	100/cs.

Hinged Plastic Containers



A. CLEARVIEW™ HINGED DELI CONTAINERS PACTIV

Hinged lid deli container.

16201013	CA91008	8 oz., Clear	200/cs.
16201012	CA91012	12 oz., Clear	200/cs.
16201016	CA91016	16 oz., Clear	200/cs.
16201024	CA91024	24 oz., Clear	200/cs.
16201032	CA91032	32 oz., Clear	200/cs.



B. CLEARVIEW™ HINGEWARE CONTAINER PACTIV

Clear hinged container.

16209747	976	12 1/2" x 5 1/2" x 2 1/4", Danish	250/cs.
----------	-----	-----------------------------------	---------

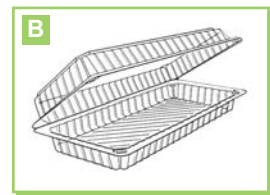

C. CLEARVIEW™ SMARTLOCK® HEXWARE™ CONTAINERS PACTIV

SmartLock® containers have an attractive black base and clear dome. The SmartLock® Closure System provides an audible click closure.

16200415	EH89160	6" x 3", Black/Clear	100/cs.
16200416	EH89170	7 1/2" x 3", Black/Clear	100/cs.
16201708	EH89170	7 1/2" x 3", Black/Clear	120/cs.
16200621	EH89190	9" x 3", Black/Clear	100/cs.
16201711	EH89190	9" x 3", Black/Clear	110/cs.
16200631	EH89193	9" x 3", 3-Compt., Black/Clear	100/cs.
16201712	EH89193	9" x 3", 3-Compt., Black/Clear	110/cs.



D. CLEARVIEW™ SMARTLOCK® HINGED CONTAINERS PACTIV

Clear hinged lid container with audible click closure.

16201426	CI81050	11 oz., 1-Compt., Clear	375/cs.
16201379	CI81160	20 oz., 1-Compt., Clear	500/cs.
16201815	CI82030	22 oz., 1-Compt., Clear	200/cs.
16200647	CI82030	22 oz., 1-Compt., Clear	250/cs.
16202752	CI82035	36 oz., 1-Compt., Clear	250/cs.
16202040	CI82040	36 oz., 1-Compt., Clear	250/cs.
16209430	CI81030	39.6 oz., 1-Compt. Deep, Clear	250/cs.
16201584	CI81120	49 oz., 1-Compt., Clear	200/cs.
16200634	CI81120	49 oz., 1-Compt., Clear	250/cs.
16200649	CI80960	53.7 oz., 1-Compt., Clear	250/cs.
16201375	CI81110	62 oz., 1-Compt., Clear	200/cs.
16201586	CI81123	5/5/14 oz., 3-Compt., Clear	200/cs.
16200633	CI81123	5/5/14 oz., 3-Compt., Clear	250/cs.
16201376	CI81113	6.7/24 oz., 3-Compt., Clear	200/cs.



E. CLEARVIEW™ SMARTLOCK® HOAGIE CONTAINERS PACTIV

Clear hinged lid containers.

16201048	CI81048	23 oz., 8 1/2" x 4" x 2 1/2"	200/cs.
16201424	CI81048	23 oz., 8 1/2" x 4" x 2 1/2"	250/cs.
16201425	CI81049	27 oz., 9 1/4" x 4 1/2" x 3"	250/cs.



F. CLEARVIEW™ SMARTLOCK® HOAGIE CONTAINER PACTIV

SmartLock® containers have an attractive black base and clear dome. The SmartLock® Closure System provides an audible click closure.

16201732	EH89148	8 1/2" x 4 1/2" x 3 1/4"	240/cs.
----------	---------	--------------------------	---------



Hinged Plastic Containers



CONTAINERS & TRAYS

A. EARTHCHOICE® SMARTLOCK® HINGED LID CONTAINERS PACTIV

Social responsibility, respect and care for the environment require action today while keeping an eye on the future. Pactiv has developed a new line of "to-go" hinged lid containers that captures the latest innovations in hybrid materials. EarthChoice™ SmartLock® hinged lid containers are made from talc-filled polypropylene which contains on average 40% less plastic polymers than standard polypropylene containers. This hybrid material is microwaveable up to 250°F and is ideal for your hot food takeout menu items. SmartLock® Closure System provides an audible "click" indicating a secure closure. Textured sidewalls provide more secure handling. Stackable.

16201421	<i>CN80600</i>	16 oz., 5 ¹⁹ / ₂₀ " x 5 ³ / ₄ " x 3 ¹ / ₄ ", Sandwich 1-Compt.	400/cs.
16201413	<i>CN80801</i>	32 oz., 8 ³ / ₁₀ " x 8 ³ / ₁₀ " x 3 ² / ₅ ", Medium 1-Compt.	200/cs.
16201405	<i>CN80901</i>	42 oz., 8 ¹⁷ / ₂₀ " x 9 ³ / ₁₀ " x 3 ³ / ₁₀ ", Large 1-Compt.	100/cs.
16201411	<i>CN80803</i>	4/4/14 oz., 8 ³ / ₁₀ " x 8 ³ / ₁₀ " x 3 ² / ₅ ", Medium 3-Compt.	200/cs.
16201404	<i>CN80903</i>	6/6/18 oz., 8 ¹⁷ / ₂₀ " x 9 ³ / ₁₀ " x 3 ³ / ₁₀ ", Large 3-Compt.	100/cs.

B. HINGED CONTAINERS PACTIV-PWP

PWP's hinged containers provide customers with the convenience of an always- attached cover, allowing for easy access to the contents. Swirl with label panel.

64933760	<i>10X7H356CSLP</i>	7" x 10" x 3 ¹ / ₂ ", 6-Compt., Clear	125/cs.
64933751	<i>08SH30SLP</i>	8 ² / ₈ " x 8 ² / ₈ " x 3", Clear	200/cs.

C. EASY-LOCK™ HINGEWARE CONTAINERS REYNOLDS® FOOD PACKAGING

Fully fluted corners provide maximum package strength to protect food contents from damage during handling and transport. Crystal clarity highlights contents to increase impulse sales. Newly designed stacking feature increases stability when packages are stacked for display or transport. Hingeware packages can be stacked without fear of shifting or collapse. The unique four corner locking system not only keeps food contents fresh and appealing but also provides security during handling.

17302656	<i>26561</i>	6"	500/cs.
17302630	<i>26301</i>	10"	200/cs.

D. PLA HINGED CONTAINERS REYNOLDS® FOOD PACKAGING

Easy to I.D. label. Ingeo™ based bioresin; "plastic from plants, not oil". Meets ASTM D6400 and also compost within eight weeks using Cedar Grove's real field testing methods.

17300095	<i>8656CGC</i>	Small, 6" x 6", Clear	210/cs.
17300096	<i>8657CGC</i>	Medium, 9" x 8", Clear	180/cs.
17300097	<i>8630CGC</i>	Large, 9" x 9 ¹ / ₂ ", Clear	100/cs.

E. REFLECTIONS® MICROWARE SUPREME™ RIB CONTAINERS REYNOLDS® FOOD PACKAGING

Ribs/entrée containers.

17307341	<i>57909MO</i>	16 ⁵ / ₈ "L x 7 ⁵ / ₁₆ "W x 2 ¹ / ₄ "D, Full Slab	100/cs.
17305791	<i>57919MO</i>	16 ⁵ / ₈ "L x 7 ³ / ₈ "W x 3"D, Full Slab	100/cs.

F. SHO-BOWL® HINGED BOWLS REYNOLDS® FOOD PACKAGING

Clear PETE plastic hinged lid containers.

18900841	<i>10841</i>	8 oz., Dome Lid	250/cs.
18900839	<i>10839</i>	8 oz., Flat Lid	250/cs.
17300034	<i>10845</i>	12 oz., Dome Lid	250/cs.
17300642	<i>10849</i>	16 oz., Dome Lid	250/cs.
18904017	<i>10847</i>	16 oz., Flat Lid	250/cs.
17300857	<i>10857</i>	20 oz., Dome Lid	150/cs.
17300029	<i>10861</i>	24 oz., Dome Lid	150/cs.
18905556	<i>10859</i>	24 oz., Flat Lid	150/cs.
17300641	<i>10865</i>	32 oz., Dome Lid	150/cs.
18906631	<i>10863</i>	32 oz., Flat Lid	150/cs.
18900129	<i>10869</i>	48 oz., Dome Lid	150/cs.

Hinged & Non-Hinged Plastic Containers



A. SNACK CLAM/PACK REYNOLDS® FOOD PACKAGING

Two compartment, hinged.

17300059 11248 8" x 6¹/₄" x 2¹/₄", 2-Compt., Clear 150/cs.



B. ULTRA FRESH™ CLAMSHELLS REYNOLDS® FOOD PACKAGING

Single clamshells.

18900082 11431 4" x 7⁷/₈" x 2", Clear 200/cs.

18900931 10931 5³/₄" x 5³/₄" x 3", 1 Pint, Clear 250/cs.



C. ULTRA FRESH™ SANDWICH WEDGES REYNOLDS® FOOD PACKAGING

Sandwich wedge with hinged lid.

17301133 11334 6¹/₂" x 3" x 3¹/₄", Clear Base/Clear Lid 250/cs.

18900029 11379 6¹/₂" x 3" x 3¹/₄", Black Base/Clear Lid 250/cs.

D. ULTRA-PAC® OCTAGON CLAMSHELLS REYNOLDS® FOOD PACKAGING

Keep your fresh cut fruits and vegetables fresh. Clear clamshell with black base.

18908525 12096 16 oz., 6¹/₂" x 2³/₈" I.D. 150/cs.

18908650 12094 22 oz., 7³/₄" x 2¹/₈" I.D. 150/cs.

18905325 12091 44 oz., 9¹/₈" x 3" I.D. 150/cs.



NON-HINGED PLASTIC CONTAINERS

E. PRIME SOURCE® ROASTER PRIME SOURCE®

Chicken roaster combo. Black base with clear dome cover.

75002591 75002591 Medium, Black/Clear 100/cs.



F. THE ROASTER™ CHICKEN ROASTER COMBO ANCHOR PACKAGING

Both dome lid and base are made of microwavable polypropylene and will not crack like polystyrene. Double vents allow steam to escape more freely to reduce condensation build-up. Clearguard® internal anti-fog is co-extruded into the lid material which eliminates the greasy feel found in other lids. Unique stacking feature keeps container secure without blocking the vents in the lid. Revolutionary V-lock™ system prevents moisture from collecting around the flange to eliminate leakage and improve lid fit.

10809001 4110001 Large 100/cs.



G. INCREDI-BOWL MICROWAVEABLE BOWLS/LID ANCHOR PACKAGING

Polypropylene bowl that can withstand temperatures of up to 230°F under heat lamps, in warming units/tunnels or in microwaves. Great for soups and hot or cold sides.

10805816 4605816 12 oz. 250/cs.

10805820 4605821 16 oz. 250/cs.

10805800 4335802 Lid Fits 12 & 16 oz., Clear 250/cs.



H. MICRORAVES® 400 MICROWAVEABLE RECTANGULAR TRAYS/LID ANCHOR PACKAGING

Microwaveable packaging with heat tolerance up to 230°F in the microwave or display case. This product is one of the toughest and lightest plastics. Unique design promotes structural integrity. Uses #4304000 or 4334000 lids.

10800414 4540416 16 oz., 8¹⁷/₂₀" x 6²/₅" x 1³/₂₀", Black 250/cs.

10800424 4540424 24 oz., 8¹⁷/₂₀" x 6²/₅" x 1¹/₂", Black 250/cs.

10800431 4540433 32 oz., 8¹⁷/₂₀" x 6²/₅" x 1¹⁹/₂₀", Black 250/cs.

10802210 4334000 Dome Lid Fits 16/24/32 oz. 250/cs.



Non-Hinged Plastic Containers



CONTAINERS & TRAYS



A. MICRORAVES® 700 **ANCHOR PACKAGING**
MICROWAVEABLE PLATTER/LID
 Microwaveable packaging with heat tolerance up to 230°F in the microwave or display case. This product is one of the toughest and lightest plastics. Unique design promotes structural integrity. Uses #4377000, 4377001, 4337000 lids.
10803540 4607102 30 oz., 10¹/₄" x 7¹/₄" x 1¹/₈", Black 250/cs.
10800035 4377000 Dome Lid Fits 30 oz., Clear 250/cs.



B. MICRORAVES® 900 DOME LID **ANCHOR PACKAGING**
 Clear packaging for fresh and chilled foods. Very good frozen and refrigerated performance. Good moisture and oxygen barrier properties with brilliant clarity. Fits #4590912 and 4590916 containers.
10809005 4409000 8" x 5⁹/₁₆" x 15/16", Clear 250/cs.



C. MICRORAVES® M400 **ANCHOR PACKAGING**
MICROWAVE COMBO PACK
 Combo Pack with black base and clear lid for maximum merchandising. Convenient case packs for retail in store packaging and storing.
10804246 4114246 24 oz. w/PP Lid 125/cs.



D. SMART-SET® PRO MICROWAVE SAFE CONTAINER **GENPAK**
 Produced with revolutionary textured microwave safe material. This texture finish feels cooler to the touch when compared to traditional microwave safe containers. Provides a more secure, less slippery finish.
34782440 FPR024 24 oz., Black 300/cs.



E. EXPRESSIONS® ECO™ BASES/LIDS **INNOWARE PLASTICS**
 Trendy, two-piece design made with environmentally friendly Ingeo™ plastic. Created from plants, not petroleum. ECO™ containers meet the ASTM Standards for Compostability as certified by the Biodegradable Products Institute. They biodegrade in a commercial compost facility within 60-180 days without releasing any toxic residues. Approved by Cedar Grove Composting, Inc., this innovative line of packaging is disposable with food waste; no separation is required!
12600021 0972013 7¹/₂" Base, Tan 300/cs.
12604015 0974015 9" Base, Tan 150/cs.
12601016 0976016 10¹/₄" Base, 3-Compt., Tan 130/cs.
12603016 0973016 Clear Lid Fits 7¹/₂" 300/cs.
12605016 0975016 Clear Lid Fits 9" 150/cs.
12601018 0977018 Clear Lid Fits 10¹/₄" 130/cs.
12603014 0973014 Solid Lid Fits 7¹/₂", Tan 300/cs.
12605014 0975014 Solid Lid Fits 9", Tan 150/cs.
12607014 0977016 Solid Lid Fits 10¹/₄", 3-Compt., Tan 130/cs.



F. VERSATAINER® MICROWAVEABLE CONTAINERS **NEWSPRING**
 Manufactured with high performance polypropylene. Delivers an outstanding combination of performance benefits and economy. Microwaveable, leak-resistant, reusable and dishwasher safe.
Rectangular
19510012 NC818B 12 oz., 4¹/₂" x 5¹/₂" x 1³/₄", Black 150/cs.
19510816 NC8168B 16 oz., Black 150/cs.
19510013 NC8288B 30 oz., 6" x 8¹/₂" x 1⁷/₈", 2-Compt., Black 150/cs.
19510838 NC838B 24 oz., 5" x 7¹/₄" x 2", Black 150/cs.
19510837 NC838BB 24 oz., 5" x 7¹/₄", Black, Bottom Only 300/cs.
19510028 NC868B 28 oz., 6" x 8¹/₂" x 1¹/₂", Black 150/cs.
19510333 NC333B 32 oz., 7¹/₂" x 9⁷/₈" x 1³/₄", 3-Compt., Black 150/cs.
19512888 NC888B 38 oz., 6" x 8¹/₂" x 2", Black 150/cs.
19510889 NC888B 38 oz., 6" x 8¹/₂" x 2", Black 300/cs.
19510989 NC989B 58 oz., Black 150/cs.
19510868 NC868 28 oz., 6" x 8¹/₂" x 1¹/₂", White 150/cs.
19510888 NC888 38 oz., 6" x 8¹/₂" x 2", White 150/cs.

Non-Hinged Plastic Containers



A. VERSATAINER® MICROWAVEABLE CONTAINERS (CONT.)

NEWSPRING

Manufactured with high performance polypropylene. Delivers an outstanding combination of performance benefits and economy. Microwaveable, leak-resistant, reusable and dishwasher safe.

Round

19510018	NC718B	16 oz., 6", Black	150/cs.
19510002	NC723B	24 oz., 7", Black	150/cs.
19510004	NC729B	32 oz., 7", Black	150/cs.
19510729	NC729B	32 oz., 7", Black	300/cs.
19519388	NC9388B	39 oz., 9", 3-Compt., Black	150/cs.
19510948	NC948B	48 oz., 9", Black	150/cs.
19510009	NC718	16 oz., 6", White	150/cs.
19510001	NC723	24 oz., 7", White	150/cs.
19510003	NC729	32 oz., 7", White	150/cs.
19519389	NC9388	39 oz., 9", 3-Compt., White	150/cs.
19510010	NC948	48 oz., 9", White	150/cs.
19510940	NC948	48 oz., 9", White	300/cs.

Square

19510627	NC626B	26 oz., 6 ³ / ₄ " x 6 ³ / ₄ " x 2"H, Black	150/cs.
19510637	NC636B	36 oz., 6 ³ / ₄ " x 6 ³ / ₄ " x 2 ⁵ / ₈ "H, Black	150/cs.



B. CLEARVIEW™ MEALMASTER™ CHICKEN BARN™ CONTAINERS

PACTIV

Chicken Barn™ container with SmartTote™ handle. Dimples/ribs in base help trap grease away from food. SmartVent™ system allows steam to vent, keeping fried foods crisp. Exceptional temperature endurance maintains product integrity for up to four hours in a hot case. Microwaveable base provides one-time microwave reheating.

16201557	CNC3004	4 pc., 9 ¹ / ₂ " x 8" x 3", Small	100/cs.
16200597	CNC3008	8 pc., 13 ³ / ₁₀ " x 8 ² / ₅ " x 4", Medium	100/cs.
16200481	CNC30080001	346 oz., Full Size Deep	100/cs.



C. CLEARVIEW™ MEALMASTER™ HMR CONTAINERS/LIDS

PACTIV

Rigid bases withstand microwave temperatures up to 220° without burn through, warping or excessive softening. Lids feature Fog Gard™ coating.

16200608	CN84612	12 oz., 6 ¹ / ₈ " x 4 ⁷ / ₈ " x 1 ⁵ / ₈ ", Small, Black	250/cs.
16200290	CN84616	16 oz., 8 ¹ / ₈ " x 6 ¹ / ₂ " x 1", Medium, Black	250/cs.
16200610	CN84624	24 oz., 8 ¹ / ₈ " x 6 ¹ / ₂ " x 1 ¹ / ₂ ", Medium, Black	250/cs.
16209463	CN84632	32 oz., 8 ¹ / ₈ " x 6 ¹ / ₂ " x 2", Medium, Black	250/cs.
16201322	CN84636	36 oz., 9 ³ / ₈ " x 8" x 1 ¹ / ₂ ", Large, Black	250/cs.
16200292	CN84637	10 oz./21 oz., 9 ³ / ₈ " x 8" x 1 ¹ / ₂ ", Large 2-Compt., Black	250/cs.
16204638	CN84638	(2) 4 ¹ / ₂ oz./21 oz., 9 ³ / ₈ " x 8" x 1 ¹ / ₂ ", Large 3-Compt., Black	250/cs.
16200468	CN8460H	Dome Lid Fits 6 ¹ / ₈ " x 4 ⁷ / ₈ ", Small, Clear	250/cs.
16201173	CN8462H	Dome Lid Fits 8 ¹ / ₈ " x 6 ¹ / ₂ ", Medium, Clear	250/cs.
16200431	CN8466H	Dome Lid Fits 9 ³ / ₈ " x 8", Large 1-Compt., Clear	250/cs.
16200457	CN8467H	Dome Lid Fits 9 ³ / ₈ " x 8", Large 2-Compt., Clear	250/cs.
16200456	CN8468H	Dome Lid Fits 9 ³ / ₈ " x 8", Large 3-Compt., Clear	250/cs.



D. CLEARVIEW™ MEALMASTER™ RIB CONTAINER W/DOME LID

PACTIV

Ideal for ribs which will be sold hot or cold and re-heated by the customer. These containers also are excellent for ribs merchandised in a hot case. Combo pack with base and dome lid with Fog Gard™ coating.

16202687	CNC6509	10 ¹³ / ₁₆ " x 7 ¹ / ₈ " x 2 ⁵ / ₁₆ ", Half Slab	80/cs.
16200229	CNC6509	10 ¹³ / ₁₆ " x 7 ¹ / ₈ " x 2 ⁵ / ₁₆ ", Half Slab	100/cs.



CONTAINERS & TRAYS

Non-Hinged Plastic Containers



CONTAINERS & TRAYS



A. CLEARVIEW™ MEALMASTER™ ROASTER COMBOS PACTIV

Black heat-resistant base and clear polystyrene dome lid. Anti-fog coating that improves merchandising and can withstand temperatures of approximately 170°F. Exclusive snap-in deli seal provides leak-resistance and helps maintain product freshness. Microwaveable base enables customers to reheat in a microwave oven. Base withstands temperatures up to 200°F. Ribbed bottom base design keeps food away from grease and excess liquid, increasing customer satisfaction and repeat sales.

16200611	<i>CNC6011</i>	Small, 24 ³ / ₁₀ oz.	100/cs.
16206007	<i>CNC6007</i>	Medium, 32 oz.	100/cs.
16202776	<i>CNC6907</i>	Handled Chicken, 32 oz.	120/cs.
16201846	<i>CNC6907</i>	Handled Chicken, 32 oz.	125/cs.
16206002	<i>CNC6002</i>	Large, 40 ¹ / ₂ oz.	100/cs.
16206003	<i>CNC6003</i>	X-Large, 50 oz.	100/cs.



B. CLEARVIEW™ MEDIUM PLATTERS/LIDS PACTIV

Plastic bases with clear dome lids.

16209882	<i>95970K</i>	13 oz., Shallow, Black	500/cs.
16202216	<i>95970K</i>	13 oz., Shallow, Black	600/cs.
16202217	<i>95980K</i>	20 oz., Deep, Black	600/cs.
16204690	<i>P95108</i>	Deep Dome Lid, 9 ³ / ₄ " x 7" x 1 ¹ / ₄ ", Clear	500/cs.
16202218	<i>P95109</i>	Deep Dome Lid Fits 20 oz., Clear	600/cs.



C. CLEARVIEW™ PORTION PLATTERS/LID PACTIV

Portion platters and lid.

16209881	<i>95940K</i>	11 oz., 7" x 6" x 1 ¹ / ₈ ", Black	500/cs.
16204695	<i>95240W</i>	11 oz., 7" x 6" x 1 ¹ / ₈ ", White	500/cs.
16204684	<i>P95105</i>	Dome Lid Fits 11 oz., Clear	500/cs.



D. CLEARVIEW™ MICROMAX® CONTAINER BASES/LIDS PACTIV

ClearView™ Micromax® containers are designed with both form and function in mind. These stylish black based containers come in a variety of convenient sizes that are perfect for reheatable sides and entrees.

16205302	<i>CN85008</i>	8 oz., 5 ⁷ / ₈ " x 4 ⁷ / ₈ " x 1 ¹ / ₄ ", Black	250/cs.
16209826	<i>CN85012</i>	12 oz., 5 ⁵ / ₁₆ " x 4 ⁹ / ₁₆ " x 2 ¹ / ₈ ", Black	250/cs.
16200274	<i>CN85016</i>	16 oz., 7 ¹ / ₂ " x 6 ⁷ / ₁₆ " x 1 ¹ / ₂ ", Black	250/cs.
16205034	<i>CN85024</i>	24 oz., 7 ¹ / ₂ " x 6 ⁷ / ₁₆ " x 1 ⁵ / ₁₆ ", Black	250/cs.
16202903	<i>CN85024</i>	24 oz., 7 ¹ / ₂ " x 6 ⁷ / ₁₆ " x 1 ⁵ / ₁₆ ", Black	252/cs.
16205032	<i>CN85032</i>	32 oz., 7 ¹ / ₂ " x 6 ⁷ / ₁₆ " x 2 ¹ / ₄ ", Black	250/cs.
16209842	<i>CN85420</i>	9 oz./20 oz., 9" x 7 ³ / ₈ " x 1 ⁷ / ₈ ", 2-Compt., Black	250/cs.
16200637	<i>CN85430</i>	(2) 4 oz./20 oz., 9" x 7 ³ / ₈ " x 1 ⁷ / ₈ ", 3-Compt., Black	250/cs.
16204662	<i>CN85101</i>	Dome Lid Fits 8/12 oz., Clear	250/cs.
16202772	<i>CN85201</i>	Dome Lid Fits 16/24/32 oz., Clear	252/cs.
16205201	<i>CN85201</i>	Dome Lid Fits 16/24/32 oz., Clear	250/cs.
16205301	<i>CN85301</i>	Dome Lid Fits 2/3 Compt., Clear	250/cs.
16200627	<i>CN85100</i>	Flat Lid Fits 8/12 oz., Clear	250/cs.
16201348	<i>CN85200</i>	Flat Lid Fits 16/24/32 oz., Clear	250/cs.



E. CLEARVIEW™ MICROMAX® OVAL CONTAINERS/LID PACTIV

ClearView™ Micromax® containers are designed with both form and function in mind. These stylish black based containers come in a variety of convenient sizes that are perfect for reheatable sides and entrees.

16205512	<i>CN85512</i>	12 oz., 7 ⁷ / ₈ " x 5 ¹ / ₄ " x 2 ¹ / ₄ ", Black	250/cs.
16205516	<i>CN85516</i>	16 oz., 7 ⁷ / ₈ " x 5 ¹ / ₄ " x 2 ¹ / ₂ ", Black	250/cs.
16205501	<i>CN85501</i>	Snap-On Lid Fits 12/16 oz., Clear	250/cs.

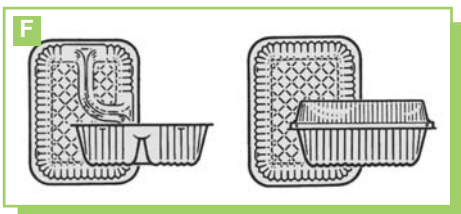

F. CLEARVIEW™ NACHO TRAY PACTIV

Plastic nacho tray.

16200282	<i>CI88062</i>	20 oz., 6 ¹ / ₂ " x 5" x 1 ³ / ₄ ", 2-Compt., Clear	500/cs.
-----------------	----------------	---	---------

Non-Hinged Plastic Containers/Bowls



A. LEAK-RESISTANT BOWL/LID PACTIV-PWP

PWP's leak-resistant bowls ensure your products stay fresher longer. Leak-resistant packages are also available with juice traps. Your products will look as fresh as the day they were born (or picked, peeled, or baked).

64930203	8X1172P	72 oz., 11" x 7 ¹ / ₂ " x 1 ³ / ₄ ", Clear	100/cs.
64930204	8X11PL	Dome Lid Fits 8" x 11"	100/cs.



B. SHOWCASE® DELI PACKAGING PACTIV

Clear plastic deli packaging.

Bases Only

16205024	C185024	24 oz., Clear	500/cs.
16205030	C185032	32 oz., Clear	500/cs.
16205048	C185048	48 oz., Clear	250/cs.
16205064	C185064	64 oz., Clear	250/cs.
16205430	C185430	(2) 4 ¹ / ₂ oz./22 ¹ / ₂ oz., 3-Compt., Clear	250/cs.

Containers w/Flat Lids

16206008	C186008	8 oz., Clear	250/cs.
16200574	C186012	12 oz., Clear	250/cs.
16200575	C186016	16 oz., Clear	250/cs.
16201830	C186024	24 oz., Clear	200/cs.
16206024	C186024	24 oz., Clear	250/cs.
16206032	C186032	32 oz., Clear	250/cs.
16206064	C186064	64 oz., Clear	125/cs.

Lids Only

16200576	C185100	Flat Lid Fits 8/12/16 oz., Clear	1000/cs.
16205200	C185200	Flat Lid Fits 24/32 oz., Clear	500/cs.
16200580	C185300	Flat Lid Fits 48/64 oz., Clear,	250/cs.
16205101	C185101	Dome Lid Fits 8/12/16 oz., Clear	1000/cs.
16205202	C185201	Dome Lid Fits 24/32 oz., Clear	500/cs.
16200577	C185301	Dome Lid Fits 48/64 oz., Clear	250/cs.



C. SHELSAVERS® SQUARE CONTAINERS/LID PACTIV-PWP

Reusable and re-sealable containers are stackable, space-saving and ideal for single-serve and Grab & Go™ applications.

64930017	04S08	8 oz., Clear	1000/cs.
64930004	04S18	18 oz., Clear	1000/cs.
64930027	04S24	24 oz., Clear	500/cs.
64930018	04SFL	Recessed Flat Lid Fits All	1000/cs.

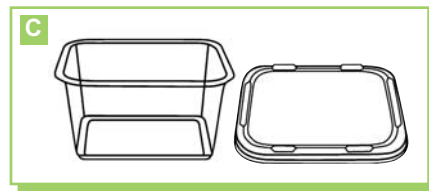

D. CONTAINER LID PACTIV-PWP

7" flat lid. For use with octagonal tubs. Box type P-4.

64930749	07FL	6 ⁵ / ₁₆ ", Clear	300/cs.
----------	------	---	---------



PLASTIC BOWLS & LIDS

E. PRESENTABOWLS® BOWL/LID COMBO DART

The crystal clarity of PresentaBowls® allows for easy product identification, while the elegant design creates an upscale presentation for your food. Designed to be stackable for stable, multi-level merchandising. Lids fit securely on bowl, sealing in freshness and creating a leak-resistant seal.

12500673	C24BCD	24 oz., w/Dome Lid	126/cs.
----------	--------	--------------------	---------





Plastic Bowls



A. NATURE FRIENDLY® PLA SALAD BOWLS/LIDS NATURE FRIENDLY PRODUCTS

Nature Friendly Products' 100% biodegradable and compostable PLA containers and trays provide consumers with an eco-friendly alternative to traditional disposables. Made from corn-based PLA renewable resources, they are completely compostable within 50-100 days in commercial composting facilities. These products are superior in strength and performance, non-toxic, and clear in color.

C6938050	<i>SB120300</i>	10 oz.	1000/cs.
C6938051	<i>SB141500</i>	18 oz.	1000/cs.
C6938052	<i>SB1781000</i>	36 oz.	500/cs.
C6938056	<i>L12025</i>	Dome Lid Fits 10 oz.	1000/cs.
C6938057	<i>L14128</i>	Dome Lid Fits 18 oz.	1000/cs.
C6938058	<i>L17832</i>	Dome Lid Fits 36 oz.	500/cs.



B. ROSEWARE® BOWL/LID COMBOS PACTIV

Made of high clarity APET. Design and material combine to provide high leak resistance and cold temperature performance.

16200280	<i>SRW24</i>	24 oz., 6 ³ / ₄ " dia., Clear	150/cs.
16202801	<i>SRW32</i>	32 oz., 6 ³ / ₄ " dia., Clear	150/cs.
16200364	<i>LRW64</i>	64 oz., 9 ³ / ₄ " dia., Clear	100/cs.



C. SHOWCASE DESIGNER® BOWLS/LIDS PACTIV

Paneled round shape makes food displays more creative and attractive. Tight-fitting lids help food stay fresher longer with fewer spills. Stable stacking lid recesses ensure stack security for better displays and easier handling. Easy-open tab.

16209197	<i>92032</i>	32 oz., Bowl Only, Clear	250/cs.
16209196	<i>92032SCH</i>	32 oz., Combo, Clear	100/cs.
16209199	<i>P92008H</i>	Dome Lid, 5 ¹ / ₂ " x 15/16"	250/cs.
16209203	<i>P92025H</i>	Dome Lid, 7 ¹ / ₂ " x 31/64"	250/cs.



D. HIGHLIGHTS® SALAD BOWLS/LIDS SOLO®

Merchandise salads, side dishes and cold entrees with our Highlights® line. These PET clear containers are simply ideal for pre-pack, self-serve and takeout applications and give their contents an enticing, fresh look. You can also try them in black for an upscale appearance.

18700775	<i>CRS8X0090</i>	8 oz., Clear	500/cs.
18700780	<i>CRS12X0090</i>	12 oz., Clear	500/cs.
18700056	<i>BRS16X0004</i>	16 oz., Black	500/cs.
18700785	<i>CRS16X0090</i>	16 oz., Clear	500/cs.
18700790	<i>CRS24X0090</i>	24 oz., Clear	500/cs.
18700320	<i>BRS32X0004</i>	32 oz., Black	300/cs.
18700640	<i>CRS32X0090</i>	32 oz., Clear	300/cs.
18700645	<i>CRS48X0090</i>	48 oz., Clear	300/cs.
18700650	<i>CRS64X0090</i>	64 oz., Clear	300/cs.
18703628	<i>LCR8D</i>	Dome Lid Fits 8-12 oz.	1000/cs.
18703636	<i>LCR16D</i>	Dome Lid Fits 16-24 oz.	1000/cs.
18701985	<i>LCR64D</i>	Dome Lid Fits 32-64 oz.	600/cs.
18703584	<i>LC64S00090</i>	Flat Lid Fits 64 oz., Clear	500/cs.

Round Deli Containers



ROUND PLASTIC DELI CONTAINERS & LIDS

A. PRIME SOURCE® DELI CONTAINERS/LIDS PRIME SOURCE®

Container and lid made from polypropylene. Resistant to fats and oils. Microwaveable and dishwasher safe.

Containers Only

75002440	75002440	8 oz., Clear	500/cs.
75002441	75002441	12 oz., Clear	500/cs.
75002442	75002442	16 oz., Clear	500/cs.
75002447	75002447	16 oz. XL, Clear	500/cs.
75002443	75002443	24 oz., Clear	500/cs.
75002444	75002444	32 oz., Clear	500/cs.
75002449	75002449	32 oz. XL, Clear	500/cs.

Combo Packs

75002460	75002460	8 oz., Clear	250/cs.
75002461	75002461	12 oz., Clear	250/cs.
75002462	75002462	16 oz., Clear	250/cs.
75002456	75002456	16 oz. XL, Clear	250/cs.
75002463	75002463	24 oz., Clear	250/cs.
75002464	75002464	32 oz., Clear	250/cs.

Lids Only

75002445	75002445	Thermoformed Lid Fits All, Clear	500/cs.
75002446	75002446	Injection-Molded Lid Fits All, Clear	500/cs.



B. PRIME SOURCE® DELI CONTAINERS/LID PRIME SOURCE®

Deli containers and lids made from polypropylene. Resistant to fats and oils. Microwaveable and dishwasher safe.

Containers Only

75002450	75002450	8 oz., White	500/cs.
75002451	75002451	12 oz., White	500/cs.
75002452	75002452	16 oz., White	500/cs.
75002453	75002453	24 oz., White	500/cs.
75002454	75002454	32 oz., White	500/cs.

Combo Packs

75002470	75002470	8 oz., White	250/cs.
75002471	75002471	12 oz., White	250/cs.
75002457	75002457	16 oz., White	250/cs.
75002473	75002473	24 oz., White	250/cs.
75002474	75002474	32 oz., White	250/cs.

Lid Only

75002458	75002458	Lid Fits All, Black	500/cs.
----------	----------	---------------------	---------



C. PRIME SOURCE® OVERCAP PRIME SOURCE®

Polypropylene overcap.

75002465	75002465	Clear	500/cs.
----------	----------	-------	---------



D. NATURE FRIENDLY® PLA ROUND CONTAINERS/LIDS NATURE FRIENDLY PRODUCTS

Nature Friendly Products' 100% biodegradable and compostable PLA containers and trays provide consumers with an eco-friendly alternative to traditional disposables. Made from corn-based PLA renewable resources, they are completely compostable within 50-100 days in commercial composting facilities. These products are superior in strength and performance, non-toxic, and clear in color.

C6938030	RC95250	8 oz., Container	2000/cs.
C6938031	U120500	16 oz., Container	1000/cs.
C6938032	U1411000	32 oz., Container	600/cs.
C6938035	L959	Lid Fits 8 oz.	2000/cs.
C6938036	L12016	Lid Fits 16 oz.	1000/cs.
C6938037	L14116	Lid Fits 32 oz.	600/cs.





Round Deli Containers

CONTAINERS & TRAYS



A. DELITAINER® MICROWAVEABLE CONTAINERS/LIDS NEWSPRING

Microwaveable, stackable, end-user reusable for the consumer and refrigerator-friendly. Leak resistant deli seal. Stackable lids and bases. Exceptional temperature endurance. Smoothwall design.

19512508	L2508	8 oz., Combo, Clear	250/cs.
19515008	L5008	8 oz., Bulk, Clear	500/cs.
19512512	L2512	12 oz., Combo, Clear	250/cs.
19515012	L5012	12 oz., Bulk, Clear	500/cs.
19512516	L2516	16 oz., Combo, Clear	250/cs.
19512517	SD2516	16 oz., Combo, Clear	250/cs.
19515016	L5016	16 oz., Bulk, Clear	500/cs.
19515017	SD5016	16 oz., Bulk, Clear	500/cs.
19512524	L2524	24 oz., Combo, Clear	250/cs.
19518328	L8328	32 oz. Squat, Combo, Clear	200/cs.
19512532	L2532	32 oz., Combo, Clear	250/cs.
19515032	L5032	32 oz., Bulk, Clear	500/cs.
19512500	NL500	Lid Fits 8/12/16/24/32 oz., Clear	500/cs.
19516065	NL640	Lid Fits 48/64 oz., Clear	120/cs.
19516064	L6064	Lid Fits 64 oz., Clear	120/cs.



B. REYNOLDS® DEL-PAK® CONTAINERS/LIDS REYNOLDS® FOOD PACKAGING

Del-Pak polypropylene containers keep foods fresh and flavorful. Del-Pak containers outperform other plastic containers for oily and acidic foods. Ideal for citrus fruit salads, gourmet peanut butter, Italian and Mexican sauces and salads made with mayonnaise. There's no taste or odor transfer. These containers are space savers with the faceted bottoms. One size lid fits 8, 12, 16 or 32 oz. containers. Custom printing up to six colors available.

Containers Only

17302080	RD208	8 oz., Clear	500/cs.
17302322	RD408	8 oz., White	500/cs.
17302160	RD216	16 oz., Clear	500/cs.
17302320	RD232	32 oz., Clear	500/cs.
17302323	RD432	32 oz., White	500/cs.

Combo Packs

17302405	RDC208	8 oz., Natural	250/cs.
17302410	RDC216	16 oz., Natural	250/cs.



C. DELI GOURMET® FOOD CONTAINERS SOLO®

Lend a touch of class to your culinary creations with these PET containers. Their crystal-clear appearance puts a spotlight on anything they hold.

18200023	DM80090	8 oz., Clear	500/cs.
18201015	DM120090	12 oz., Clear	500/cs.
18201059	DM160090	16 oz., Clear	500/cs.
18200321	DM32	32 oz., Clear	500/cs.



D. ECO-FORWARD™ DELI CONTAINERS/LIDS SOLO®

We're "Bringing Alternative Resources for the Environment". Bare™ by Solo® is the industry's first single-use packaging brand with a broad environmental platform. Premium Bare™ deli containers and lids are made with 20% recycled content and maintain exceptional contact clarity, presenting a better option for the environment, and for your deli. Superb clarity; glass-like appearance highlights food visibility. Crack resistant. Stackable; minimize storage space. Solo's superior lid fit substantially reduces leaks and maintains product freshness. Handles product temperature ranges between 20° and 160°F.

18201562	DM8R0090	8 oz.	500/cs.
18201560	DM16R0090	16 oz.	500/cs.
18200008	LG8N0090	Recessed Lid Fits All Sizes, Clear	500/cs.
18201577	LG8R0090	Recessed Lid Fits All Sizes, Clear	500/cs.

Round Deli & Dessert Containers



A. MAXIMIZERS® PLASTIC FOOD CONTAINERS SOLO®

Polystyrene containers for cultured products, deli salads and other foods with less than 18% fat. Spoonable bottoms with resealable lids.

18703602	<i>GW87SH00007</i>	8 ⁷ / ₁₀ oz., White	500/cs.
18701322	<i>GW166H00007</i>	16 ¹ / ₅ oz., White	500/cs.
18701323	<i>GW33TH00007</i>	33 oz., White	250/cs.



B. MICROGOURMET® FOOD CONTAINERS SOLO®

Busy operations will appreciate how this line allows prepackaged foods to be refrigerated and microwave-heated in the same polypropylene container. Five different container sizes use one common lid.

18200119	<i>MN8</i>	8 oz., Translucent	500/cs.
18201784	<i>MN16</i>	16 oz., Translucent	500/cs.
18200103	<i>16NW</i>	16 oz., White	500/cs.
18200118	<i>MN32</i>	32 oz., Translucent	500/cs.



C. SOLO® M LINE FOOD CONTAINERS/LIDS SOLO®

Great for salads, gelatins, and condiments since they are made from Mtrene®, which makes them resistant to fats, oils and temperatures from -18 to 82°C.

18703740	<i>ME400090</i>	4 oz., Clear	1000/cs.
18703750	<i>ME5S00090</i>	5 oz., Clear	1000/cs.
18703588	<i>LME3</i>	Recessed Lid Fits 4 oz., Clear	1000/cs.
18703592	<i>LME600090</i>	Recessed Lid Fits 5 oz., Clear	1000/cs.



D. ROUND FOOD CONTAINER LID SOLO®

18201008	<i>NL8RT0100</i>	Recessed Lid, Translucent	500/cs.
-----------------	------------------	---------------------------	---------



PLASTIC DESSERT CONTAINERS

E. DESSERT DISH/LID GEORGIA PACIFIC FOODSERVICE

Plastic dessert dish.

15000908	<i>DD08C</i>	8 oz., Clear	1000/cs.
15007455	<i>DD05FL</i>	Flat Lid Fits 5/8 oz., Clear	500/cs.



F. SOLOSERVE® DESSERT CUPS SOLO®

Plastic specialty food containers.

18205500	<i>SD5</i>	5 oz., Clear	1000/cs.
18205505	<i>SD80090</i>	8 oz., Clear	1000/cs.
18205510	<i>SD12</i>	12 oz., Clear	1000/cs.



G. SUNDAE CUPS/LIDS SOLO®

Half the fun of serving ice cream treats is watching your customers' eyes light up when they see what's coming. So we make our sundae cups from PET to give your customers a better view.

18205880	<i>TS5</i>	5 oz., Clear	1000/cs.
18205881	<i>TS9</i>	9 oz. Tall, Clear	1200/cs.
18201035	<i>DL100</i>	Dome Lid Fits 5/9 oz., Clear	500/cs.
18200024	<i>DL620</i>	Dome Lid Fits 9 oz., Clear	25/100/cs.

H. DESSERT CONTAINER SOLO®

Render your customers powerless by showing off your most tantalizing desserts in one of our attractive polystyrene containers.

18701628	<i>F5DB00090</i>	5 oz., Clear	1000/cs.
-----------------	------------------	--------------	----------



I. BANANA BOAT® SOLO®

Banana splits are taken to another level in a polystyrene banana boat.

18700420	<i>B45DX00090</i>	13 ⁷ / ₁₀ oz., Clear	600/cs.
-----------------	-------------------	--	---------



Hinged Foam Containers

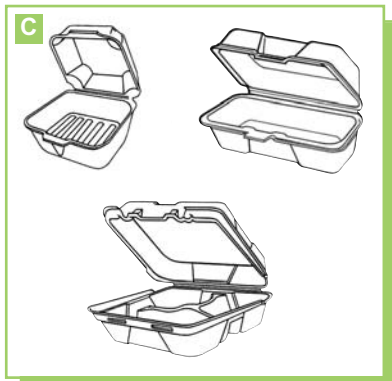
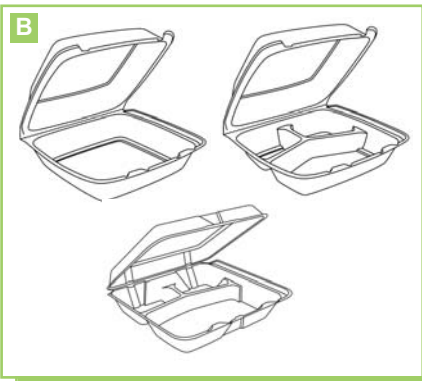

CONTAINERS & TRAYS

HINGED FOAM CONTAINERS

A. PRIME SOURCE® FOAM HINGED CONTAINERS PRIME SOURCE®

Foam hinged compartment container.

75002901	75002901	6" x 6" x 3", Medium 1-Compt.	500/cs.
75002910	75002910	8" x 8 1/2" x 3", Medium 1-Compt.	200/cs.
75002913	75002913	8" x 8 1/4" x 3 1/2", Medium 3-Compt.	200/cs.
75002904	75002904	9" x 9" x 3 1/4", Large 1-Compt.	200/cs.
75002905	75002905	9" x 9" x 3 1/4", Large 3-Compt.	200/cs.

B. FOAM HINGED LID CONTAINERS - REMOVABLE LIDS DART

Secure closure improves handling and helps protect against accidental openings. Foam insulation is ideal for transporting and storing both hot and cold foods.

12500206	85HT1	8 3/8" x 7 1/8" x 3 1/4", Medium, White	200/cs.
12500207	85HT3	8 3/8" x 7 1/8" x 3 1/4", Medium 3-Compt., White	200/cs.
12500410	95HT1	9 1/2" x 9 1/4" x 3", Large, White	200/cs.
12500405	95HT3	9 1/2" x 9 1/4" x 3", Large 3-Compt., White	200/cs.

C. HINGED FOAM CONTAINERS GENPAK

Hinged containers feature a stacking rim for safe handling of multiple meals, vapor control side seams to ensure freshness and super-secure locking systems to keep food in place.

34784028	22400	5 1/8" x 5 3/16" x 2 3/4", Medium, White	500/cs.
34780129	22500	5 5/8" x 5 3/4" x 3 1/4", Large, Sesame	500/cs.
34780120	22500	5 5/8" x 5 3/4" x 3 1/4", Large, White	500/cs.
34782110	21100	7" x 3 3/16" x 2 1/4", Hot Dog, White	500/cs.
34784005	20400	8 1/4" x 5 3/16" x 2", Medium Shallow, White	250/cs.
34782170	21700	8 1/4" x 5 3/16" x 3", Medium, White	500/cs.
34782160	21600	8 7/8" x 4 3/16" x 3 1/16", Medium, White	500/cs.
34780175	23000	8 7/8" x 9 1/4" x 3", Medium, White	200/cs.
34780100	23300	8 7/8" x 9 1/4" x 3", Medium 3-Compt., White	200/cs.
34780110	20500	9 3/16" x 6 1/2" x 3 1/16", Large, White	200/cs.
34782010	20010	9 1/4" x 9 1/4" x 3", Large, White	200/cs.
34780102	20010V	9 1/4" x 9 1/4" x 3", Large, White (Vented)	200/cs.
34780151	2031013	9 1/4" x 9 1/4" x 3", Large 3-Compt., Beige	200/cs.
34780150	20310	9 1/4" x 9 1/4" x 3", Large 3-Compt., White	200/cs.
34782190	21900	9 1/2" x 5 1/4" x 3 1/2", Large, White	200/cs.
34780006	25000	10 1/4" x 9 1/4" x 3 1/2", Jumbo, White	200/cs.
34780200	25300	10 1/4" x 9 1/4" x 3 1/2", Jumbo 3-Compt., White	200/cs.
34784030	26600	13 3/16" x 4 1/2" x 3 1/8", X-Large, White	200/cs.
Snap-It®			
34780222	SN225BK	5 13/16" x 5 11/16" x 3 1/8", Large Sandwich, Black	500/cs.
34780224	SN225	5 13/16" x 5 11/16" x 3 1/8", Large Sandwich, White	500/cs.
34780177	SN227	6 3/8" x 6 7/16" x 2 15/16", Jumbo Sandwich, White	500/cs.
34782020	SN220	7 5/8" x 8 7/16" x 2 3/8", Small, White	200/cs.
34780223	SN223	7 5/8" x 8 7/16" x 2 3/8", Small 3-Compt., White	200/cs.
34782101	SN100SMILE	7 7/8" x 8 5/8" x 2 1/2", Small, Smile	200/cs.
34782100	SN100	7 7/8" x 8 5/8" x 2 1/2", Small, White	200/cs.
34781103	SN103	7 7/8" x 8 5/8" x 2 1/2", Small 3-Compt., White	200/cs.
34780113	SN240	8" x 8" x 3", Medium, White	200/cs.
34781431	SN243BK	8" x 8" x 3", Medium 3-Compt., Black	200/cs.
34781430	SN243	8" x 8" x 3", Medium 3-Compt., White	200/cs.
34780181	SN200BK	9 1/4" x 9 1/4" x 3", Large, Black	200/cs.
34780176	SN200	9 1/4" x 9 1/4" x 3", Large, White	200/cs.
34780173	SN203	9 1/4" x 9 1/4" x 3", Large 3-Compt., White	200/cs.

Hinged Foam Containers



A. DL (DOUBLE LAMINATED) HINGED FOAM CONTAINERS PACTIV

Laminated on the inside and outside of the container for maximum heat tolerance and strength. Insulated to keep hot foods HOT and cold foods COLD. Double-slot closure.

16201451	Y80661	Medium 1-Compt.	150/cs.
16201506	YU80661CSUPC	Medium 1-Compt.	150/cs.
16201439	80215	Medium 3-Compt. (Shallow)	150/cs.
16201248	80215	Medium 3-Compt. (Shallow)	200/cs.
16201453	80663	Medium 3-Compt.	150/cs.
16201458	80581	Large 1-Compt.	150/cs.
16201449	80583	Large 3-Compt.	150/cs.



B. FOAM CLAMSHELLS PACTIV

Foam clamshells.

16201228	HD1P8L1	8" x 8", 1-Compt., Happy Face	150/cs.
16201229	HD3P8L1	8" x 8", 3-Compt., Happy Face	150/cs.



C. HINGED FOAM CONTAINERS PACTIV

Hinged containers with dual tabs.

16202030	TD18801	8 ² / ₅ " x 8 ¹ / ₁₀ " x 3", Medium 1-Compt.	150/cs.
16209921	TD18801	8 ² / ₅ " x 8 ¹ / ₁₀ " x 3", Medium 1-Compt.	200/cs.
16202053	TD18803	8 ² / ₅ " x 8 ¹ / ₁₀ " x 3", Medium 3-Compt.	150/cs.
16209915	TD18803	8 ² / ₅ " x 8 ¹ / ₁₀ " x 3", Medium 3-Compt.	200/cs.
16202056	TD19901	9" x 9" x 3 ¹ / ₂ ", Large 1-Compt.	150/cs.
16209900	TD19901	9" x 9" x 3 ¹ / ₂ ", Large 1-Compt.	200/cs.
16202036	TD19903	9" x 9" x 3 ¹ / ₂ ", Large 3-Compt.	150/cs.
16209903	TD19903	9" x 9" x 3 ¹ / ₂ ", Large 3-Compt.	200/cs.



D. HINGED LID CONTAINERS PACTIV

Conventional white foam hinged lid containers.

16201542	TH10079	5 ¹ / ₈ " x 5 ¹ / ₈ " x 2 ¹ / ₂ ", Small Square	500/cs.
16201554	TH10080	6" x 6" x 3", Medium Square	500/cs.
16201544	TH10081	6 ³ / ₈ " x 6 ³ / ₈ " x 3", Large Square	500/cs.
16200186	TH10098	7 ¹ / ₄ " x 3" x 2", Small Sandwich	500/cs.
16202311	TH10098	7 ¹ / ₄ " x 3" x 2", Small Sandwich	504/cs.
16202314	TH10089	9 ¹ / ₈ " x 6 ¹ / ₈ " x 3 ¹ / ₄ ", Large Deep	200/cs.
16200913	TH10206	9 ⁹ / ₁₆ " x 6 ¹ / ₂ " x 1 ⁵ / ₈ ", Large Shallow	200/cs.
16200269	TH10205	9 ⁹ / ₁₆ " x 6 ¹ / ₂ " x 2 ³ / ₄ ", Large Deep	200/cs.
16200694	TH10099	9 ³ / ₄ " x 5" x 3 ¹ / ₄ ", Large Deep	500/cs.
16200035	TH10061	9 ³ / ₄ " x 9 ¹ / ₂ " x 3", X-Large 1-Compt.	200/cs.
16201648	TH10063	9 ³ / ₄ " x 9 ¹ / ₂ " x 3", X-Large 3-Compt.	250/cs.



E. PLACESETTER® PREMIER FOOD CONTAINERS PACTIV

Rich black color enhances all food presentations, superior high gloss appearance. Extra-sturdy double lamination, excellent for heavy product.

16201548	TXB0600	5 ³ / ₄ " x 5 ³ / ₄ ", Large Sandwich, Black	500/cs.
16201429	TXB0901	9" x 9", Large, Black	150/cs.





Hinged & Non-Hinged Foam Containers

CONTAINERS & TRAYS



A. SMARTLOCK® HINGED LID CONTAINERS PACTIV

White Smartlock® foam hinged lid container. A smart choice for confidence that your container is securely closed.

16201533	HLW0600	5 ³ / ₄ " x 5 ³ / ₄ " x 3 ¹ / ₄ ", Medium Sandwich	500/cs.
16201381	HLW0701	7 ¹ / ₂ " x 8" x 2 ⁵ / ₈ ", Small	150/cs.
16201382	HLW0703	7 ¹ / ₂ " x 8" x 2 ⁵ / ₈ ", Small 3-Compt.	150/cs.
16201143	HLW0703	7 ¹ / ₂ " x 8" x 2 ⁵ / ₈ ", Small 3-Compt.	200/cs.
16201383	HLW0801	8" x 8 ¹ / ₂ " x 3", Medium	150/cs.
16201386	HLW0803	8" x 8 ¹ / ₂ " x 3", Medium 3-Compt.	150/cs.
16200951	HLW0803	8" x 8 ¹ / ₂ " x 3", Medium 3-Compt.	200/cs.
16201323	HLW0184	8 ³ / ₄ " x 4 ¹ / ₂ " x 3 ¹ / ₈ ", Medium Sandwich	500/cs.
16201306	HLW0188	8 ³ / ₄ " x 5 ¹ / ₂ " x 3", Medium	250/cs.
16201390	HLW0901	9" x 9 ¹ / ₂ " x 3 ¹ / ₄ ", Large	150/cs.
16201536	HLWV901	9" x 9 ¹ / ₂ " x 3 ¹ / ₄ ", Large 1-Compt. (Vented)	200/cs.
16201393	HLW0903	9" x 9 ¹ / ₂ " x 3 ¹ / ₄ ", Large 3-Compt.	150/cs.
16201318	HLW0903	9" x 9 ¹ / ₂ " x 3 ¹ / ₄ ", Large 3-Compt.	200/cs.
16201534	HLWV903	9" x 9 ¹ / ₂ " x 3 ¹ / ₄ ", Large 3-Compt. (Vented)	200/cs.
16201338	HLW0189	9 ⁵ / ₁₆ " x 6 ³ / ₁₆ " x 3 ¹ / ₄ ", Large Rectangular	200/cs.
16201319	HLW1001	9 ¹ / ₂ " x 10 ¹ / ₂ " x 3 ¹ / ₄ ", X-Large	200/cs.
16201640	HLW1001	9 ¹ / ₂ " x 10 ¹ / ₂ " x 3 ¹ / ₄ ", X-Large	250/cs.
16201321	HLW1003	9 ¹ / ₂ " x 10 ¹ / ₂ " x 3 ¹ / ₄ ", X-Large 3-Compt.	200/cs.
16201646	HLW1003	9 ¹ / ₂ " x 10 ¹ / ₂ " x 3 ¹ / ₄ ", X-Large 3-Compt.	250/cs.

NON-HINGED FOAM CONTAINERS

B. FOOD CONTAINERS DART

Insulated foam containers keep food at its proper temperature. Nest closely to minimize cube and maximize storage space. Separate easily for quicker dispensing. Contains no CFCs.

12508084	4J6	4 oz., White	1000/cs.
12508086	6SJ12	6 oz. Squat, White	1000/cs.
12508088	8SJ12	8 oz. Squat, White	1000/cs.
12508108	8SJ20	8 oz. X-Squat, White	1000/cs.
12507220	12SJ20	12 oz., White	500/cs.
12500156	16MJ20	16 oz. Squat, White	500/cs.
12500160	16MJ32	16 oz. X-Squat, White	500/cs.
12500188	32MJ48	32 oz., White	500/cs.

C. SMART-SET® HEXAGON SERVING TRAY GENPAK

Insulates hot and cold food products better than solid plastic packaging. Unique hexagon, black design stands out for an upscale presentation. Anti-fog, crystal clear lid snaps on and seals the container. Stacking lid design for easy take out.

34780193	HX0193L	9 ⁵ / ₃₂ " x 1 ³ / ₄ ", Deep, Black	200/cs.
----------	---------	---	---------

D. SMART-SET® INSULATED BASE/LID GENPAK

Two-piece containers keep food equally fresh and secure and when fitted with a crystal clear plastic lid, are perfect for attractive food display.

34785030	50310BK	8 ⁷ / ₈ " x 10 ⁵ / ₈ " x 1 ¹ / ₄ ", 3-Compt., Black	250/cs.
34784045	94500	Lid, 9 ³ / ₈ " x 7 ³ / ₈ " x 1 ⁵ / ₈ ", Clear	250/cs.

E. HANDI-KUP® UNIVERSAL HOT/COLD FOOD CONTAINERS WINCUP

Smoothwall foam containers.

19400404	F4	4 oz., White	1000/cs.
19400407	F6	6 oz., White	1000/cs.
19401788	F8	8 oz., White	500/cs.
19400411	F12	12 oz., White	500/cs.
19400416	F16	16 oz., White	500/cs.
19401621	F16HVY	16 oz., Heavy-Duty, White	500/cs.
19400432	F32	32 oz., White	250/cs.

Foam & Aluminum Containers



A. WINCUP® UNIVERSAL HOT/COLD FOOD CONTAINER WINCUP

WinCup foam food containers and bowls provide great insulation for hot or cold food items and are great for delis and take out meals.

19404125 12FC 12 oz., White 500/cs.



ALUMINUM CONTAINERS

B. UTILITY CUPS PACTIV

Full curl rim.

16208233 40225 2 oz., Aluminum 2000/cs.

16206365 42330 4 1/5 oz., Aluminum 1000/cs.



C. PIE PLATES PACTIV

Aluminum pie plates.

16207645 20940 22 oz., 9", Medium 500/cs.

16207647 21940 30 oz., 9", X- Deep 500/cs.

16207652 23045 32 oz., 10", X- Deep 500/cs.



D. POT PIE PACTIV

Aluminum pot pie pan.

16207641 40525 7 1/2 oz. 1000/cs.



E. ANGEL FOOD PAN PACTIV

Aluminum angel food pan.

16208201 4018WPPC 55 oz., 8", w/Preset Cup & Dome 100/cs.



F. ALUMINUM ROUND CONTAINERS/COVERS PACTIV

Aluminum round with hemmed edge.

16208527 52725 7" 500/cs.

16208520 55830 8" 500/cs.

16201811 50930 9" 300/cs.

16206445 L527 Board Cover Fits 7" 500/cs.

16206545 L509 Board Cover Fits 9" 500/cs.



G. ROUND PAN PACTIV

FC rim.

16208257 49835 30 1/2 oz., 8" Medium 500/cs.

H. HOLIDAY FOIL HEART PANS/LID PACTIV

Foil heart pans.

16208850 605530DR 12 oz., Small, Red 100/cs.

16208830 69030DR 39 1/2 oz., Large, Red 100/cs.

16204634 P690 Dome Cover Fits Large, Clear 100/cs.



I. RACK 'N' ROAST® ALUMINUM ROASTER PACTIV

Large crown ovenable roaster with full curl rim.

16206278 6278XH 256 3/10 oz., Large Oval 25/cs.



J. CLASSIC CARRY-OUT™ ALUMINUM BASE W/DOME PACTIV

Black and gold foil base with clear plastic lid with Fog Gard™ coating.

16206708 6708WPSFG 22 oz., Dome Lid 100/cs.



Aluminum Containers

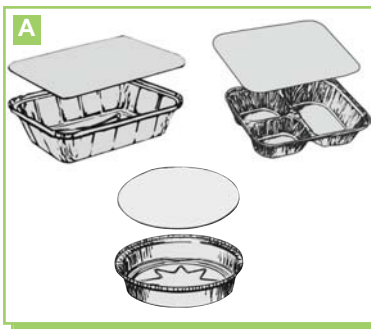

A. THRIFT-PACK® CARRY OUT COMBOS

PACTIV

Aluminum carry out containers with foil laminated board covers.

16209136	788TP	8½" x 6" x 1¾", Carry-Out	250/cs.
16209119	7139TP	8½" x 6½" x 1½", Hi-Divider 3-Compt.	250/cs.
16208840	509TP	9" dia. x 1¾", Round	200/cs.

B. OBLONG PANS/COVERS

PACTIV

Interrupted vertical curl.

16209127	70530	1 lb.	1000/cs.
16202372	70530	1 lb.	1200/cs.
16200747	74730	1½ lb.	500/cs.
16202145	78830	2½ lb.	400/cs.
16209135	78830	2¼ lb.	500/cs.
16208829	702145	4lb.	250/cs.
16200225	L705	Board Cover Fits 1 lb.	1000/cs.
16203400	L788	Board Cover Fits 1½ lb./2¼ lb.	500/cs.
16207021	L7021	Board Cover Fits 4 lb.	250/cs.



C. LOAF PANS

PACTIV

Full Curl Rim

16208857	61635	1 lb. Loaf Pan	1000/cs.
16208824	63735	1½ lb. Loaf Pan	500/cs.
16200835	60835	2 lb. Loaf Pan	500/cs.

Interrupted Vertical Curl Rim

16209125	70845	2 lb., Loaf Pan	500/cs.
16208805	79945	5 lb., Loaf Pan	250/cs.



D. MUFFIN PANS

PACTIV

Four- and six-cavity muffin pans.

16208835	6951130	3½ oz., 6-Cavity	500/cs.
16208870	654835	5¼ oz., 4-Cavity	250/cs.



E. SHEET CAKE PAN/COVER

PACTIV

Aluminum sheet cake pan.

16208818	614255	1/2 Size, 116 oz.	100/cs.
16204628	P6142	Dome Lid Fits 1/2 Size	100/cs.

F. SQUARE CAKE PAN

PACTIV

Full curl rim.

16208827	66435	8" Square	500/cs.
----------	-------	-----------	---------



G. WINDOW-PACK® SQUARE CAKE PAN W/LID

PACTIV

Aluminum pan with clear plastic dome.

16209108	664WP	8" Square	100/cs.
----------	-------	-----------	---------



H. REYNOLDS® UTILITY CUP

REYNOLDS® FOOD PACKAGING

Reynolds® aluminum 4 oz. cup containers serve many sectors of foodservice programs. Versatility is the key - use aluminum containers for cooking, freezing, storing and serving. Aluminum containers can go directly from the freezer to the oven and back to the freezer. Aluminum is compatible with virtually all foods and is odor and moisture proof. Rigid aluminum containers travel easily and are ideal for both hot and cold foods. This container has the RL904 board lid available.

17300006	RC904	4 oz., Plain, .0030	1000/cs.
----------	-------	---------------------	----------



Aluminum Containers



A. REYNOLDS® TAKEOUT CONTAINERS

REYNOLDS® FOOD PACKAGING

Provide convenience to many sectors of foodservice programs. Versatility is the key; use aluminum containers for baking, freezing, storing and serving. Aluminum containers can go directly from the freezer to the oven and back to the freezer. Aluminum is compatible with virtually all foods and is odor and moisture proof. Rigid aluminum containers travel easily and are ideal for both hot and cold foods.

Containers Only

17300425	RC425	7" Round, 25 oz., .0025	500/cs.
17304360	RC436	7" Round, 26 oz., .0030	500/cs.
17300470	RC477	9" Round, 46 ⁹ / ₁₀ oz.	500/cs.
17300910	RC685	2 ¹ / ₂ lb. Oblong Entrée Pan, 36 oz., .0030	500/cs.

Combo-Paks (With Foil Board Lids)

17300477	RCL477	46 ¹ / ₅ oz., 1-Compt. Round	200/cs.
17300478	RCL478	46 ¹ / ₅ oz., 1-Compt. Round, .0030	200/cs.
17307500	RCL750	5.8/5.8/13.2 oz., 3-Compt. Tray	200/cs.



B. REYNOLDS® CAKE PAN

REYNOLDS® FOOD PACKAGING

Reynolds® aluminum sheet cake pans serve all sectors of foodservice. Versatility is the key. Use aluminum containers for baking, freezing, storing and serving. In fact, aluminum can go directly from the freezer to the oven and back to the freezer. Aluminum is compatible with virtually all foods and is odor and moisture proof. Rigid aluminum containers travel easily and are ideal for both hot and cold foods. This container has the RP585 plastic lid available.

17305870	RC587	1/2 Sheet, 120 ¹ / ₅ oz., .0055	100/cs.
----------	-------	---	---------



ALUMINUM STEAMTABLE PANS/LIDS

C. STEAMTABLE PAN

PACTIV

Pactiv's steamtable pans combine the strength, durability, and economy of an aluminum container for both hot and cold food presentations. Allows food to be prepared, heated, refrigerated, shipped and served all in the same pan. Ideal for main courses, casseroles, vegetables, side dishes, and desserts.

16206133	6132L	1/2 Size Deep, 120 oz.	100/cs.
----------	-------	------------------------	---------



D. STEAMTABLE PANS/COVERS

PACTIV

Aluminum steamtable pans combine strength, durability and economy for both hot and cold food presentations. Allows food to be prepared, heated, refrigerated, shipped and served all in the same pan.

16206110	6110XH	Full Size, Shallow	50/cs.
16201721	6120XH	Full Size, Medium	40/cs.
16201434	6050XH	Full Size, Deep	40/cs.
16200407	6012XH	1/2 Size, Shallow	100/cs.
16201735	6112XH	1/2 Size, Medium	100/cs.
16201737	6132XH	1/2 Size, Deep	100/cs.
16201730	6132H	1/2 Size, Deep	500/cs.
16208865	634260	1/2 Size, Extra Deep	100/cs.
16208819	606245	1/3 Size, Deep	150/cs.
16201432	112045	Cover Fits Full Size	80/cs.
16207325	101230	Cover Fits 1/2 Size	100/cs.



E. REYNOLDS®

STEAMTABLE PANS/LIDS

REYNOLDS® FOOD PACKAGING

Reynolds® aluminum steam pans serve all sectors of foodservice. Versatility is the key. Use aluminum containers for cooking, freezing, storing and serving. In fact, aluminum can go directly from the freezer to the oven and back to the freezer. Aluminum is compatible with virtually all foods and is odor and moisture proof. Rigid aluminum containers travel easily and are ideal for both hot and cold foods.

17301173	RC1173	Full Size, Deep, 342 oz.	50/cs.
17300101	RC1174	Full Size, Deep, 342 oz., .0070	50/cs.
17303144	RC1144	1/2 Size, Medium, 104 oz., .0045	100/cs.
17301149	RC1149	1/2 Size, Deep, 120 oz.	100/cs.
17301150	RC1150	1/2 Size, Deep, 120 oz., .0045	100/cs.
17309900	RL990	Foil Board Lid Fits Full Size	50/cs.
17309700	RL970	Foil Board Lid Fits 1/2 Size	100/cs.



CONTAINERS & TRAYS

To-Go Cups/Buckets/Popcorn Containers



TO-GO CUPS/BUCKETS/ TUBS

A. FRENCH FRY CARTON DOPACO

Traditional nested fry carton.

66376152 6152 3 1/2 oz., Regular 1000/cs.

B. DIXIE® FRENCH FRY CARTON GEORGIA PACIFIC FOODSERVICE

Features one-piece construction. Easy to assemble. Units store flat, saving valuable storage space.

15001976 977SAGE 4 1/8" x 3 5/8" x 1 1/4", Sage™ 1500/cs.

C. FRENCH FRY CUPS SOLO®

French fries and beyond, we've got everything you need to package hot, fried foods.

Formulated to be grease resistant and hold up to your tastiest menu items.

18701899 GRS1200021 12 oz., Great Fries® 1000/cs.

18701900 GRS1600021 16 oz., Great Fries® 1000/cs.

D. MUNCHIE CUPS® SOLO®

French fries and beyond, we've got everything you need to package hot, fried foods. Our paper containers are formulated to be grease resistant and hold up to your tastiest menu items. Fold-down lid.

18700896 GF2400645 2 2/5 oz. 1000/cs.

18700524 GF3500645 3 1/2 oz. 1000/cs.

18700045 GF4500645 4 1/2 oz. 1000/cs.

E. PAPER FOOD BUCKETS/TUBS/LIDS SOLO®

Double wrapped bucket. Pressure-welded side seams, interlocked bottoms and high quality wax treatments produce leak resistant containers.

Waxed Double Wrapped

18708535 5T3M 83 oz., Marble 100/cs.

18708537 5T3 83 oz., White 100/cs.

18707340 10T300069 165 oz., Marble 100/cs.

18703141 10T3N0199 165 oz., White 100/cs.

Unwaxed Double Wrapped

18707907 3T102050 53 oz., White, Untreated Paper 300/cs.

18708530 5T102050 83 oz., White, Untreated Paper 100/cs.

18205429 10T102050 165 oz., White, Untreated Paper 100/cs.

18707328 10T1 165 oz., White 100/cs.

Vita-Glaze®

18702052 8T1GR02050 128 oz., White 100/cs.

Vented Finger Bucket Lids - Grease-Resistant

18708515 5VT19SN1125 Fits 5T1, 5T1GR, 5T3, 8T1GR, White 100/cs.

18200607 10V19S02050 Fits 10T1, 10T3, 10TR25, White 100/cs.

POPCORN CONTAINERS

F. POPCORN BOXES GRAPHIC PACKAGING INTL

Auto bottom box. Clay coated inside.

13400035 1008100 5 5/8" x 2 1/8" x 8 1/2" 500/cs.

13400045 4E 5 3/4" x 2 1/2" x 8 1/2" 250/cs.

G. POPCORN BUCKETS SOLO®

Equipped with Vita-Glaze® grease resistant coating. Easy to fill, pressure-welded side seams and rigid, tightly rolled rims.

18706304 V2400061 24 oz., Popcorn, Double Poly Paper 1000/cs.

18706312 VL32 32 oz., Paper 500/cs.

18706316 VB4600059 46 oz., Premiere, Double Poly Paper 500/cs.

18706320 VG8500061 85 oz., Popcorn, Paper 150/cs.

Takeout Containers



TAKEOUT CONTAINERS

A. "OUR DELI" DELI BOXES PRIME SOURCE®

Fast top. Auto bottom.

77000001	77000001	2-3 pc., 7" x 4 ¹ / ₄ " x 2 ³ / ₄ ", 100% Recyclable	200/cs.
77004901	77004901	2-3 pc., 7" x 4 ¹ / ₄ " x 2 ³ / ₄ "	200/cs.
77000002	77000002	4-6 pc., 9" x 5" x 3", 100% Recyclable	200/cs.
77004904	77004904	9 ¹ / ₂ " x 5" x 5"	125/cs.



B. DIXIE® CARRYOUT CARTONS GEORGIA PACIFIC FOODSERVICE

Non-polycoated carryout cartons.

15001694	960SAGE	7" x 4 ¹ / ₂ " x 2 ³ / ₄ ", Snack Size, Sage™	250/cs.
15001760	964SAGE	9" x 5" x 3", Dinner, Sage™	250/cs.



C. DIXIE® TAKEOUT CARTON GEORGIA PACIFIC FOODSERVICE

Non-polycoated barn carton.

15001762	965SAGE	5 lb., 8 ¹ / ₂ " x 5 ¹ / ₂ " x 3 ¹ / ₂ ", Sage™	250/cs.
----------	---------	---	---------



D. CHICKEN BOX GRAPHIC PACKAGING INTL

Basket weave pattern tuck-top barn box.

13405005	340	7" x 4 ¹ / ₄ " x 2 ³ / ₄ ", Small, Red	500/cs.
----------	-----	--	---------

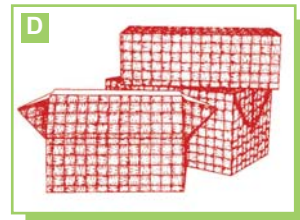

E. BIO-PAK® FOOD CONTAINERS FOLD-PAK

Microwavable, stackable, one-piece design requires no assembly. Poly-coated interior with clay-coated exterior. Leak resistant; holds foods, sauces, and gravies. Heat lamp resistant. Retains heat and vents steam effectively.

26080030	01BPBLACKM	#1, 22 oz., Black	450/cs.
26080008	03BPBLACKM	#3, 56 oz., Black	200/cs.
26080007	04BPBLACKM	#4, 75 oz., Black	160/cs.
26080410	08BPBLACKM	#8, 29 oz., Black	300/cs.
26080001	BP1WHITEM	#1, 22 oz. Squat, White	450/cs.
26089804	01BPWHITEM	#1, 22 oz., White	450/cs.
26089604	02BPWHITEM	#2, 36 oz., White	200/cs.
26089800	03BPWHITEM	#3, 56 oz., White	200/cs.
26089810	04BPWHITEM	#4, 75 oz., White	160/cs.
26080400	08BPWHITEM	#8, 29 oz., White	300/cs.



F. BIO-PLUS® FOOD CONTAINERS FOLD-PAK

Microwavable, stackable, one-piece design requires no assembly. 100% recycled paper-board with a minimum of 35% post-consumer Recycled Content. Leak resistant; holds foods, sauces, and gravies. Heat lamp resistant. Retains heat and vents steam effectively.

26080043	01BPEARHTM	#1, 22 oz., Earth	450/cs.
26080067	02BPEARHTM	#2, 36 oz., Earth	200/cs.
26080042	03BPEARHTM	#3, 56 oz., Earth	200/cs.
26088001	04BPEARHTM	#4, 75 oz., Earth	160/cs.
26088000	08BPEARHTM	#8, 29 oz., Earth	300/cs.
26081000	08BPSONOMM	#8, 29 oz., Sonoma	300/cs.



G. FOLD-PAK® PAGODA MICRO FOOD PAILS FOLD-PAK

Paperboard food pails without wire handle (microwavable).

26089639	08MWPAGODM	8 oz. (1/2 Pint), Pagoda Design	450/cs.
26089773	16MWPAGODM	16 oz. (Pint), Pagoda Design	450/cs.
26089641	26MWPAGODM	26 oz., Pagoda Design	450/cs.
26089774	32MWPAGODM	32 oz. (Quart), Pagoda Design	450/cs.



Takeout & Pizza Containers/Produce/Snack Trays



A. FOLD-PAK® WHITE MICRO FOOD PAILS			FOLD-PAK
Paperboard food pails without wire handle (microwavable).			
26083232	16MWWHITEM	16 oz. (Pint), White	450/cs.
26089634	26MWWHITEM	26 oz., White	450/cs.



B. FOLD-PAK® WHITE WIRE FOOD PAIL			FOLD-PAK
Paperboard food pail with wire handle.			
26089622	16WHWHITEM	16 oz. (Pint), White	500/cs.



C. SMARTSERV™ ASIAN TAKEOUT CONTAINER			FOLD-PAK
SmartServ containers are extremely effective for hot, cold, wet or dry food products. The cup shape makes it easy to fill and comfortable to hold. They are leak and grease resistant and fully microwavable. SmartServ containers are easy to store in the kitchen and are nested like cups for easy use. Best of all, SmartServ has a one piece design which eliminates the common food container/lid not fitting issue.			
26080020	26SSPRINTM	26 oz., Chinese Design (Red)	500/cs.



PIZZA CONTAINERS/LID SUPPORTS

D. PIZZA CLAMSHELL			DOPACO
Hinged, nested clamshell is easy to use and easy to store.			
66373703	3703	18/6 Slice Size, 10 ³ / ₁₆ " x 9 ¹³ / ₃₂ " x 1 ⁵ / ₈ ", White	220/cs.



E. TAKEOUT CARTONS		GEORGIA PACIFIC FOODSERVICE	
Polycoated pizza slice cartons.			
15009692	SC001	7 ¹ / ₄ " x 6" x 1 ³ / ₄ ", Small, Italian	500/cs.
15000694	SC003	9" x 9 ³ / ₈ " x 1 ⁵ / ₈ ", Large, Italian	200/cs.



F. CLASSIC STONEWARE® ROUND PIZZA TRAYS			PACTIV
Dual ovenable paperboard can be used in a microwave or conventional oven at temperatures up to 400°F for 60 minutes.			
16201056	PCS01305	For 12" Pizza, White	250/cs.
16201055	PCS01505	For 14" Pizza, White	250/cs.



G. PRIME SOURCE® PIZZA STAX LID SUPPORTS			PRIME SOURCE®
Plastic pizza box lid supports.			
76002501	76002501	Green	1M/cs.
76002500	76002500	White	1M/cs.



H. PIZZA STAND			NEWSPRING
Mediumweight, high performance polypropylene.			
19510075	PZ1000	White	1000/cs.



PRODUCE BASKETS

I. THE GARDEN PARTY® BERIGARD BERRY BASKETS/LID			PACTIV
Molded fiber berry basket. Berigard® berry baskets are ideal for all kinds of berries (strawberries, raspberries, blueberries). Molded fiber is the natural choice to absorb the excess juices from produce and display that farm fresh image.			
16200313	M336126	1 Pint, 4 ¹ / ₈ " x 4 ¹ / ₈ " x 2 ⁷ / ₈ ", Green	600/cs.
16200314	M336184	1 qt., 5 ¹ / ₂ " x 5 ¹ / ₂ " x 3 ¹ / ₄ ", Green	250/cs.
16209704	P92505	Lid Fits 1 qt. Basket, Clear	500/cs.



PAPER SNACK/HOT DOG TRAYS

J. ECOCRAFT® FOOD TRAY			BAGCRAFT/PAPERCON
Made from recycled natural kraft paper stock using an FDA approved, chlorine-free manufacturing process.			
10906990	300699	3 lb.	500/cs.

CONTAINERS & TRAYS

Paper Snack & Food Trays



A. FOOD TRAYS

DOPACO

Serve big or small portions in this wide range of food trays. Clay coated. Compostable.

66375811	5811	4 oz., #25, Basketweave	1000/cs.
66375802	5802	6 oz., #40, Basketweave	1000/cs.
66375803	5803	8 oz., #50, Basketweave	1000/cs.
66375804	5804	1 lb., #100, Basketweave	1000/cs.
66375814	5814	2 lb., #200, Basketweave	1000/cs.
66375813	5813	2½ lb., #250, Basketweave	500/cs.
66375815	5815	3 lb., #300, Basketweave	500/cs.
66375817	5817	5 lb., #500, Basketweave	500/cs.



B. HOT DOG TRAY

DOPACO

Standard hot dog tray.

66375877	5877	5" x 1¾" x 1⅞", Basketweave	1000/cs.
----------	------	-----------------------------	----------

C. DIXIE® KANT LEEK®

FOOD TRAYS

GEORGIA PACIFIC FOODSERVICE

Kant Leek® food trays are polycoated and durable to resist moisture and grease without the need for liners.

15001591	KL300SAGE8	3 lb., 8⅞" x 5⅓⅓" x 2⅓⅓", Sage™	500/cs.
15001693	KL500SAGE8	5 lb., 9⅞" x 6⅓⅓" x 2⅓⅓", Sage™	500/cs.



D. FOOD TRAYS

GEORGIA PACIFIC FOODSERVICE

Made from a sheet of clay-coated board. The one-piece construction results in an economical open-top container to serve a wide variety of uses.

15001216	RP408	6 oz., Red Plaid	1000/cs.
15005220	RP50	1/2 lb., Red Plaid	1000/cs.
15005204	RP1008	1 lb., Red Plaid	1000/cs.
15005211	RP2008	2 lb., Red Plaid	1000/cs.
15005212	RP3008	3 lb., Red Plaid	500/cs.
15005215	RP3008	3 lb., Red Plaid	500/cs.
15005225	RP500	5 lb., Red Plaid	500/cs.



E. FLUTED HOT DOG TRAYS

GEORGIA PACIFIC FOODSERVICE

Paper hot dog trays.

15008050	HD8050	8", Mediumweight, White	3000/cs.
15002210	HD8075	8", Heavyweight, White	3000/cs.



F. HOT DOG TRAYS

SMITH LEE

Closed, rounded end.

18108200	4085	8", Mediumweight, White	3000/cs.
18104080	4080	8", Heavyweight, White	3000/cs.

G. FOOD TRAY

SOLO®

Paper tray offers convenience, portion control and an economic way of serving everything from condiments to the main entrée. Uniformly angled side walls.

10304330	35300	3 lb., #300, Red Plaid	500/cs.
----------	-------	------------------------	---------



PAPER FOOD TRAYS

H. CARRYOUT TRAY

GRAPHIC PACKAGING INTL

Natural chipboard. Made from tan bending chip, a type of recycled sheet.

13403825	20013525	10½" x 10½" x 3¾"	200/cs.
----------	----------	-------------------	---------



I. SAVADAY® MOLDED FIBER FOOD TRAYS

HUHTAMAKI

Made from natural molded fiber which absorbs excess oils from fried food. Using Savaday food trays during food preparation can reduce grease spillage on kitchen floors. Helps keep grease out of kitchen drains.

15302805	10408	6" x 4", #50, Natural, Jump	1000/cs.
15302810	10403	7" x 5", #100, Natural, Jess	1000/cs.
15302820	10405	9" x 7", #300, Natural, Just	500/cs.



CONTAINERS & TRAYS



Food & Cafeteria Trays

CONTAINERS & TRAYS

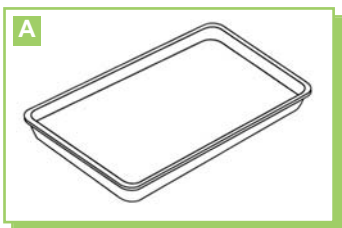

A. SERVICEWARE® MOLDED FIBER FLAT TRAYS HUHTAMAKI

Molded fiber items are molded paper fiber formed into uniquely shaped products to assure strength and rigidity in foodservice operations.

15301615	20917	8" x 6" x 1", Beige	500/cs.
15301605	20918	9" x 7" x 1", Beige	500/cs.
15305835	20815	12" x 9" x 1", Beige	250/cs.
15305830	20802	12" x 9" x 1", White	250/cs.
15300020	20803	12" x 16", White	200/cs.
15301620	20804	14" x 18", White	100/cs.



B. NATURE FRIENDLY® TRAYS NATURE FRIENDLY PRODUCTS

Nature Friendly Products' 100% biodegradable and compostable tableware provides consumers with an eco-friendly alternative to traditional disposables. Made from sugar cane bagasse-based renewable resources, they are completely compostable within 50-100 days in home and commercial composting facilities. These products are superior in strength and performance. Non-toxic, hot/cold tolerant, oil and water resistant, microwave and freezer safe.

C6934006	T009	8 1/2" x 10 1/2", 5-Compt.	500/cs.
C6934001	T002	9 1/5" x 6 7/5", 1-Compt.	500/cs.



PAPER CAFETERIA TRAYS

C. ECO-LINE TRAY BRIDGE-GATE ALLIANCE GROUP

Made from 100% sugarcane. Heavy-duty. Biodegradable and compostable. FDA approved for food use. Oil, grease, and water resistant. Microwaveable. Certified by the Biodegradable Products Institute.

B7280157	ECO108T	10 2/5" x 8 1/2", 5-Compt.	500/cs.
-----------------	---------	----------------------------	---------



D. NATURAL BROWN FOOD TRAY BRIDGE-GATE ALLIANCE GROUP

Compostable natural fiber take-out packaging. Made from 100% renewable resources. BPI Certified. Designed to disintegrate and biodegrade swiftly and safely in a professionally-managed composting facility.

B7280014	BGW108T	10 2/5" x 8 1/2", 5-Compt.	500/cs.
-----------------	---------	----------------------------	---------



E. TRAY BRIDGE-GATE ALLIANCE GROUP

Premium dinnerware made from renewable resources. Biodegradable and compostable. FDA approved for food use. Grease and water resistant. Microwaveable. BPI certified.

B7280108	BG108T	5-Compt.	500/cs.
-----------------	--------	----------	---------



F. CHINET® MOLDED FIBER CAFETERIA TRAYS HUHTAMAKI

Sturdy, easy to handle trays that are made of 100% pre-consumer recycled fiber. Molded fiber is good for the table and good for the earth.

15301624	21076	8 1/2" x 10 1/2", 5-Compt., Natural, Flash	250/cs.
15306320	22025	8 1/2" x 10 1/2", 5-Compt., White, Valley	500/cs.
15306310	22021	8 1/2" x 12 1/2", 6-Compt., White, Valise	500/cs.

G. SAVADAY® MOLDED FIBER FOOD & BEVERAGE CARRIERS HUHTAMAKI

Molded fiber food and beverage trays made of 100% recycled fiber are famous for their unmatched strength. Cup wells are designed to firmly grip cups which reduces spills. One-piece construction requires no set up time.

15300962	20962	8 to 22 oz., 13" x 10" x 2", White, Flag	200/cs.
15301665	20961	8 to 22 oz., 15" x 11" x 2", Beige, Focus	200/cs.



Cafeteria Trays/Food & Beverage Carriers



FOAM CAFETERIA TRAYS

A. SCHOOL SERVING TRAY GENPAK

The smart, one-piece alternative to plates and cumbersome undertrays.

34780033 10500 5-Compt., White, Sesame 500/cs.

B. PLACESETTER® DELUXE FOAM SERVING TRAY PACTIV

Premium quality laminated foam construction.

16200092 TK10136 14" x 18", White 100/cs.

C. SCHOOL LUNCH TRAYS PACTIV

Foam school lunch trays.

16200304 TH10500 8½" x 10¼", 5-Compt., White 500/cs.

16200306 TH10601 8½" x 11½", 6-Compt., White 500/cs.

D. STAINWARE® NON-LAMINATED TRAY PACTIV

Satin non-laminated foam lunch tray.

16200265 TH10034 9" x 12", White 250/cs.



FOOD & BEVERAGE CARRIERS

E. HANDLED DRINK CARRIER GRAPHIC PACKAGING INTL

Handled drink carriers will not rip or tip due to their superior wet strength and deep compartments. Hold large and small drinks with push-in straps to secure smaller drinks.

13408233 200 2-Cup, 8" x 3½" x 10½" 250/cs.

F. STRONGHOLDER® MOLDED FIBER BEVERAGE CARRIER HUHTAMAKI

Molded fiber beverage carriers, made of 99% reclaimed fiber, are famous for their unmatched strength.

15300963 20963 2-Cup, 8 to 44 oz. 300/cs.

G. STRONGHOLDER® MOLDED FIBER 4-CUP BEVERAGE CARRIERS HUHTAMAKI

Molded fiber beverage carriers, made of 99% reclaimed fiber, are famous for their unmatched strength. Molded fibers are good for the table and good for the earth. Extra-strong grease absorbers. Four cup wells for holding multiple drinks.

15301650 20972 8 to 22 oz. 300/cs.

15300945 20945 8 to 32 oz. 200/cs.

15300221 20994 8 to 32 oz. 300/cs.

15302178 20985 8 to 46 oz. 100/cs.

H. STRONGHOLDER® MOLDED FIBER FOOD & BEVERAGE CARRIERS HUHTAMAKI

Molded fiber food and beverage trays made of 100% recycled fiber are famous for their unmatched strength. Cup wells are designed to firmly grip cups which reduces spills. One-piece construction requires no set up time.

4-Cup Carrier w/Food Tray

15301635 20969 8 to 22 oz., Narrow, Beige 250/cs.

15300024 20968 8 to 44 oz., Wide, Beige 150/cs.

2-Cup Carrier w/Food Tray

15301640 20974 8 to 22 oz., Beige 400/cs.

15300202 20975 8 to 22 oz., Narrow, Beige 250/cs.

15300990 20990 8 to 44 oz., Wide, Beige 100/cs.

I. CARRY-SAFE® BEVERAGE CARRIER PACTIV

Made from 100% recycled paper (mostly newsprint). Strong and ready-to-use with no set up required to speed your customers on their way.

16200165 M513504 8 to 46 oz. Cups, 4 Plus® Cup 150/cs.

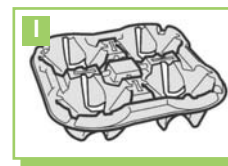

CONTAINERS & TRAYS

Beverage Carriers/Bakery Boxes/Cake Circles



CONTAINERS & TRAYS

A. CARRY-SAFE® CARRY OUT TRAYS PACTIV

Molded fiber carry out trays.

16200175	<i>M527535</i>	2-Cup, 8 to 24 oz. Cups	250/cs.
16200170	<i>M527543</i>	4-Cup, 8 to 24 oz. Cups	250/cs.

B. CARRY-SAFE® CRUISER MOVER™ BEVERAGE CARRIER PACTIV

Molded fiber four-cup beverage carrier. Carry-Safe® cup and beverage carriers are made from 100% recycled paper (mostly newsprint). They can carry beverages only or food and beverages. They hold a wide variety of cup sizes from 8 oz. to 32 oz. Strong and ready-to-use with no set up required to speed your customers on their way.

16203521	<i>M510032</i>	8 to 32 oz. Cups	300/cs.
-----------------	----------------	------------------	---------

BAKERY BOXES

C. "OUR BAKERY" BAKERY BOXES PRIME SOURCE®

Time saver window. Solid bleached sulfate board carton.

Cake Boxes

77000011	<i>77000011</i>	8" x 6" x 3", White	125/cs.
77001102	<i>77001102</i>	9" x 9" x 4", White	75/cs.
77000010	<i>77000010</i>	14" x 10" x 4", Quarter Sheet, White	75/cs.
77000014	<i>77000014</i>	19" x 14" x 4", Half Sheet, White	25/cs.

Donuts/Cookies/Cupcake Boxes

77001203	<i>80310045</i>	9" x 4 1/2" x 4", 1 Dozen, White	125/cs.
77001202	<i>77001202</i>	10 1/4" x 8" x 4", 1 Dozen, White	125/cs.

D. BAKERS' CRAFT™ BAKERY BOXES CLIMAX MFG

Manufactured from 100% recycled fiber, 30% post-consumer waste.

Cake Boxes

25234116	<i>BX411615</i>	10" x 10" x 5"	100/cs.
25234117	<i>BX411616</i>	14" x 10" x 4", Quarter Sheet	100/cs.
25234118	<i>BX441622</i>	19" x 14" x 4", Half Sheet	50/cs.
25234115	<i>BX451623</i>	26" x 18" x 3", Full Sheet	25/cs.

Pie Boxes

25234111	<i>BX411611</i>	8" x 8" x 2 1/2"	100/cs.
25234112	<i>BX493370</i>	10" x 10" x 2 1/2"	100/cs.

Donut Boxes

25234114	<i>BX411634</i>	9" x 4 1/2" x 4", 1/2 Dozen	100/cs.
25234113	<i>BX411636</i>	10 1/4" x 8" x 4", 1 Dozen	100/cs.

CAKE CIRCLES/BOARDS

E. SAVADAY® MOLDED FIBER CIRCLES HUHTAMAKI

Molded fiber items are molded paper fiber formed into uniquely shaped products to assure strength and rigidity in foodservice operations. For baked items the pie plates provide the right size for all your needs. Plus, molded fiber items accept excess fats from baked goods, keeping pies flaky.

15302510	<i>10210</i>	8"	1000/cs.
15301028	<i>10228</i>	10"	250/cs.

F. GOLDEN LACE™ CAKE CIRCLES/BOARDS MENASHA PACKAGING

Golden Lace™ combines the warmth and richness of gold, the softness of lace, and the beauty of scalloped edges to create a sophisticated, luxurious presentation.

54210208	<i>GOL8</i>	8", Gold	200/cs.
54210210	<i>GOL9</i>	9", Gold	200/cs.
54210203	<i>GOL10</i>	10", Gold	200/cs.
54210211	<i>GOL12</i>	12", Gold	100/cs.
54210204	<i>GOLQ</i>	13 3/4" x 9 1/4", 1/4 Sheet, Gold	100/cs.
54210205	<i>GOLH</i>	18 3/4" x 13 3/4", 1/2 Sheet, Gold	50/cs.
54210200	<i>GOLDWH</i>	18 3/4" x 13 3/4", 1/2 Sheet, Gold, Double Thick	25/cs.
54210201	<i>GOLF</i>	25 1/2" x 17 1/2", Full Sheet, Gold	50/cs.

Cake Circles/Bakery Packaging



A. CAKE CIRCLES PACTIV

Features a clean, bright appearance. Extremely lightweight. Sturdy white foam. Circular ribs provide easy handling and the strength to support heavy loads.

16201384	60725	7 ¹ / ₄ "	100/cs.
16201340	60800	8"	500/cs.
16201493	60900	9"	500/cs.
16201342	60900Z	9", Scalloped Edge	500/cs.



CAKE PACKAGING

B. TWO PIECE CAKE SET INLINE PLASTICS

8" round or square cake with dome. Combo pack includes 8000 base.

39358300	8300C	10 ¹ / ₄ " x 10 ¹ / ₄ " x 4 ⁵ / ₁₆ " OD, Shallow Dome	56/cs.
-----------------	-------	---	--------



C. CAKE PACKAGING PACTIV

Clear cake packages with dome lids.

16209802	C189802	1-2 Layer Cakes, 10 ¹ / ₄ ", Shallow Dome Lids for 8"	100/cs.
16209901	C189901	1-2 Layer Cakes, 11", Shallow Dome Lids for 8"	100/cs.
16201839	C189801	2-3 Layer Cake, 10 ¹ / ₄ ", Deep Dome Lid for 8"	100/cs.



D. CLEARVIEW™ SMARTLOCK® POUND CAKE CONTAINER PACTIV

ClearView™ SmartLock® bakery containers provide excellent strength, clarity and an audible locking feature.

16201818	C183011	31 oz., 5 ¹ / ₂ " x 9 ¹ / ₈ " x 3 ³ / ₈ ", Clear	290/cs.
-----------------	---------	--	---------



E. ROSEDOME™ SHEET CAKE COMBOS PACTIV

Plastic APET cake combos with black bases and clear domes.

Round Cake

16200263	CB1025BR525R	8" Cake, 10 ¹ / ₄ " x 5 ¹ / ₄ "	100/cs.
-----------------	--------------	---	---------

Sheet Cake

16205971	HSB500R	1/2 Sheet, 5"H	25/cs.
-----------------	---------	----------------	--------



F. SHOWCAKE® CAKE PACKAGING PACTIV

Provide strong, crystal clear packaging. The sturdy ribbed construction protects bakery items and enhances appearance.

Black Base/Clear Dome

16201848	EH89802	1-2 Layers, 8" Cake	100/cs.
16200701	EH89701	2-3 Layers, 7" Cake	100/cs.
16201847	EH89801	2-3 Layers, 8" Cake	100/cs.

Clear Base/Clear Dome

16200261	9510SKH	10" Deep	50/cs.
-----------------	---------	----------	--------



G. SMARTLOCK® SHOWCAKE® CAKE PACKAGING PACTIV

Clear base and clear dome lid. Tight seal plastic bases and domes with Loc Tight™ closure that prevents opening of the packages while on display or during transport. Includes foam cake board.

16201857	9519SK	11 ⁹ / ₁₆ " x 6 ⁹ / ₁₆ " x 4 ¹ / ₂ ", Bar Cake	100/cs.
16209717	9714SKH	15 ³ / ₈ " x 11 ³ / ₈ " x 5", 1/4 Sheet Deep	50/cs.
16209774	9714SKS	15 ³ / ₈ " x 11 ³ / ₈ " x 3 ¹ / ₂ ", 1/4 Sheet Shallow	50/cs.
16209892	9719SKH	20 ³ / ₈ " x 15 ³ / ₈ " x 5", 1/2 Sheet Deep	25/cs.



H. FLUTED CONTAINER PACTIV-PWP

Fluted clear plastic container.

64930730	07F48	48 oz.	300/cs.
-----------------	-------	--------	---------





Bakery Packaging

CONTAINERS & TRAYS

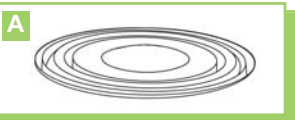

A. CAKE BASE		PACTIV-PWP
Flat bottom cake base.		
64930160	09B For 7" Cake, Black	200/cs.



B. ROUND CAKE COMBOS		PACTIV-PWP
Black bases with dome lids.		
Fluted Dome Lids		
64930152	10B50 For 8" Cake, 5"H	100/cs.
64931150	11B50 For 9" Cake, 5"H	50/cs.
64931317	13B35 For 11" Cake, 3 1/2"H	50/cs.
Swirl Dome Lids		
64930164	10B525SG For 8" Cake	100/cs.
64931409	11BR45S For 9" Cake	50/cs.



C. SHEET CAKE COMBOS		PACTIV-PWP
Sheet cake swirl domes with black bases.		
64931600	PES50 1/8 Sheet, 9 5/8" x 7 3/4" x 5", Special Order	100/cs.
64930426	PQS425S 1/4 Sheet, 14 1/2" x 10 3/4" x 4 1/2"	50/cs.
64930556	PQS50SLP 1/4 Sheet w/Label Panel, 14 1/2" x 10 3/4" x 5"	100/cs.
64930049	PHS50S 1/2 Sheet, 20" x 15" x 5"	50/cs.



D. BAKEABLES™ ANGEL FOOD CAKE PANS/LID		REYNOLDS® FOOD PACKAGING
Ovenable and microwaveable angel food cake pans and after bake lids.		
18900212	13297 48 oz., 8" dia. x 3"H, 1, Natural	280/cs.
18900211	13300 82 oz., 9" dia. x 4"H, 5, Black	200/cs.
18901048	11848 Dome Lid Fits 10" dia., Clear	200/cs.



E. CAKE CONTAINER COMBOS		REYNOLDS® FOOD PACKAGING
Black cake bases with clear dome lids.		
Round Cake		
18903486	13486 72 oz., Black/Clear	100/cs.
Sheet Cakes		
18900358	10358 1/8 Sheet, 9 1/2" x 7 1/4" x 4", Black/Clear	100/cs.
18902454	12454 1/4 Sheet, 13 1/4" x 9 1/2" x 5", Black/Clear	55/cs.
18900292	10394 1/2 Sheet, 18" x 13" x 5 1/8", Black/Clear	25/cs.



F. ULTRA FRESH™ SLICE CLAMSHELL		REYNOLDS® FOOD PACKAGING
Cake/pie slice clamshell.		
18900809	10803 3", Clear	250/cs.



G. ULTRA FRESH™ HALF ROUND CAKE BASE/DOME		REYNOLDS® FOOD PACKAGING
Dome 4" total inside height. Black base and dome.		
18900027	10252 4", Black	100/cs.



H. ULTRA PAC™ CAKE BASES W/DOMES		REYNOLDS® FOOD PACKAGING
Cake base and dome combination.		
18900026	10097 9" dia. x 3"H, Black/Clear	100/cs.
18900025	10117 9" dia. x 5"H, Black/Clear	100/cs.
18900141	10043 10" dia. x 5"H, White/Clear	100/cs.



I. ULTRA PAC™ CAKE/CUPCAKE COMBO		REYNOLDS® FOOD PACKAGING
Holds one dozen cupcakes and one 8" cake.		
18902438	12438 16" dia. x 3 1/2", Black/Clear	25/cs.



J. ULTRA VIEW™ CAKE COMBO		REYNOLDS® FOOD PACKAGING
Round black base with clear dome lid.		
17303493	13493 10" Cake, 12 3/4" dia. x 6"H	50/cs.

Bakery Packaging



PIE PACKAGING

A. PIE CONTAINER

PACTIV

One-piece hinged pie container.

16209019 C189019 9 oz., 9", Deep, Clear 500/cs.



B. PIE CONTAINER

PACTIV

Two-piece, clear top and black bottom provides an excellent presentation.

16208945 EH89045 42 oz., 10", w/Shallow Dome, Black/Clear 125/cs.

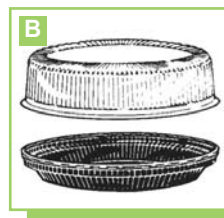

C. SHOWPIE® PIE PACKAGING

PACTIV

Clear one-piece hingeware provides an excellent presentation for pies.

16200005 9710S 11" x 2⁷/₈", Shallow 100/cs.

16209770 9710H 11" x 3¹/₄", Deep 100/cs.



D. PIE COMBO

PACTIV-PWP

Swirl dome with black base.

64930122 09PG125SG 9" x 1¹/₄", For 8" Pie 100/cs.



MISC. BAKERY PACKAGING

E. BAKE 'N SHOW PIZZA/COOKIE TRAY

GENPAK

Made of environmentally friendly CPET material. Can use in conventional and convection ovens to 450°F. Also microwaveable. Fill and freeze with batter for baking later. Stack and ship rigid design.

34780014 55C12 12³/₄" x 1", Black 100/cs.



F. SURE LOCK® CUPCAKE CONTAINER

INLINE PLASTICS

(6) frosted cupcakes, muffins.

39350136 SL36 6 ct., 9³/₈" x 6³/₈" x 2¹/₄", Clear 300/cs.

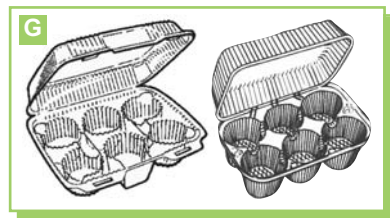

G. CLEARVIEW™ SMARTLOCK® CUPCAKE/MUFFIN CONTAINERS

PACTIV

ClearView™ SmartLock® bakery containers provide excellent strength, clarity and an audible locking feature.

16200788 C189060 9³/₄" x 6⁷/₈" x 3", 6-Compt. (Shallow), Clear 250/cs.

16202068 C189360 9³/₄" x 6⁷/₈" x 3³/₄", 6-Compt. (Deep), Clear 250/cs.

16209818 9146 10¹/₄" x 6⁷/₈" x 3⁵/₈", 6-Compt., Clear 100/cs.

16209446 C189446 13" x 10¹/₁₆" x 3¹/₈", 12-Compt., Clear 100/cs.

H. CUPCAKE COMBO

PACTIV

Plastic cupcake combo.

16201028 CB675B625R 6³/₄", 6¹/₂" Rosedome Lid, Black/Clear 160/cs.



I. HINGED COMPARTMENT CONTAINER

PACTIV-PWP

Swirl bakery with label panel. Outstanding clarity for product visibility.

64933770 13X10H3512CSLP 10" x 13" x 3¹/₂", 12-Compt., Clear 150/cs.



J. BAKEABLES™ SINGLE SERVE CUP

REYNOLDS® FOOD PACKAGING

Ovenable and microwavable.

17302263 12263 7 oz., Black 720/cs.



CONTAINERS & TRAYS

Bakery Packaging



A. BAR-LOCK MUFFIN/ CUPCAKE CONTAINER REYNOLDS® FOOD PACKAGING

Hinged container for muffins or cupcakes.

14902016 2016 3 1/2 oz., 6-Compt., Deep 100/cs.

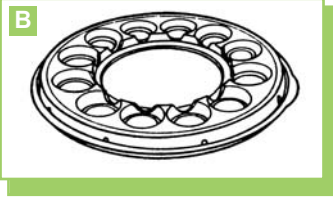

B. ULTRA FRESH™ CAKE/CUPCAKE TRAY/COMBO REYNOLDS® FOOD PACKAGING

Black tray for one dozen cupcakes or one 8" cake.

18900203 13408 Base Only, 16" dia., Black 50/cs.

18900897 10885 Dome Lid Only, Fits 16", Clear 50/cs.

18903358 13358 Tray/Lid Combo, 16" dia. x 3 1/2", Black/Clear 25/cs.



C. ULTRA FRESH™ CUPCAKE CLAMSHELL REYNOLDS® FOOD PACKAGING

Twelve count cupcake clamshell.

18909783 10783 13" x 10" 3/2", 12-Count, Clear 100/cs.

D. ULTRA PAC™ BAKERY TRAY REYNOLDS® FOOD PACKAGING

Great for over-wrapped croissants, bakery or produce items.

18902314 12314 18" x 13" x 3 3/4", Clear 125/cs.



Grocery Bags



GROCERY BAGS/BARREL SACKS

A. GROCERY BAGS

DURO BAG

Kraft paper grocery bags.

Natural

13200010	80001	1/2 lb., 3" x 17/8" x 57/8", 30#	1000/bdl.
13200012	80003	1 lb., 3 1/2" x 2 7/8" x 6 7/8", 30#	800/bdl.
13200340	81006	2 lb., 4 5/16" x 2 7/16" x 7 7/8", 30#	500/bdl.
13200014	80005	2 lb., 4 5/16" x 2 7/16" x 7 7/8", 30#	6000/bdl.
13200101	80006	3 lb., 4 3/4" x 2 5/16" x 8 9/16", 30#	5000/bdl.
13200208	81007	4 lb., 5" x 3 1/3" x 9 3/4", 30#	500/bdl.
13200015	80007	4 lb., 5" x 3 1/3" x 9 3/4", 30#	4000/bdl.
13200016	80009	5 lb., 5 1/4" x 3 7/16" x 10 15/16", 35#	3000/bdl.
13200204	80983	6 lb., 6" x 3 5/8" x 11 1/16", 35#	500/bdl.
13200017	80010	6 lb., 6" x 3 5/8" x 11 1/16", 35#	2000/bdl.
13200206	80984	8 lb., 6 1/8" x 4 1/6" x 12 7/16", 35#	500/bdl.
13200018	80957	8 lb., 6 1/8" x 4 1/6" x 12 7/16", 35#	2000/bdl.
13200985	80985	10 lb., 6 5/16" x 4 3/16" x 13 3/8", 35#	500/bdl.
13200019	80958	10 lb., 6 5/16" x 4 3/16" x 13 3/8", 35#	2000/bdl.
13200982	80982	12 lb., 7 1/16" x 4 1/2" x 13 3/4", 40# Valu Pak	500/bdl.
13200023	80959	12 lb., 7 1/16" x 4 1/2" x 13 3/4", 40#	1000/bdl.
13200178	80976	16 lb., 7 3/4" x 4 13/16" x 16", 40# Valu Pak	500/bdl.
13200024	80960	16 lb., 7 3/4" x 4 13/16" x 16", 40#	1000/bdl.
13200025	80961	20 lb., 8 1/4" x 5 5/16" x 16 1/8", 40#	1000/bdl.
13200979	80979	20 lb. Shorty, 8 1/4" x 5 5/16" x 13 3/8", 40# Valu Pak	500/bdl.
13200026	80962	20 lb. Shorty, 8 1/4" x 5 5/16" x 13 3/8", 40#	1000/bdl.
13200027	80963	25 lb., 8 1/4" x 5 1/2" x 18", Heavy-Duty, 40#	1000/bdl.
13200980	80980	25 lb. Shorty, 8 1/4" x 6 1/8" x 15 7/8", 40#	500/bdl.
13200034	80964	25 lb. Shorty, 8 1/4" x 6 1/8" x 15 7/8", 40#	1000/bdl.

White

13201232	81232	2 lb., 4 5/16" x 2 7/16" x 7 7/8", 30#	500/bdl.
13200032	80023	2 lb., 4 5/16" x 2 7/16" x 7 7/8", 30#	6000/bdl.
13202100	80024	3 lb., 4 3/4" x 2 5/16" x 8 9/16", 30#	5000/bdl.
13200213	81250	4 lb., 5" x 3 1/3" x 9 3/4", 30#	500/bdl.
13200035	80025	4 lb., 5" x 3 1/3" x 9 3/4", 30#	4000/bdl.
13200205	80026	5 lb., 5 1/4" x 3 7/16" x 10 15/16", 35#	3000/bdl.
13200211	81223	6 lb., 6" x 3 5/8" x 11 1/16", 35#	500/bdl.
13200036	80027	6 lb., 6" x 3 5/8" x 11 1/16", 35#	2000/bdl.
13200215	81273	8 lb., 6 1/8" x 4 1/6" x 12 7/16", 35#	500/bdl.
13200037	80965	8 lb., 6 1/8" x 4 1/6" x 12 7/16", 35#	2000/bdl.
132002165	81274	10 lb., 6 5/16" x 4 3/16" x 13 3/8", 35#	500/bdl.
13200038	80966	10 lb., 6 5/16" x 4 3/16" x 13 3/8", 35#	2000/bdl.
13200209	81004	12 lb., 7 1/16" x 4 1/2" x 13 3/4", 40#	500/bdl.
13200039	80967	12 lb., 7 1/16" x 4 1/2" x 13 3/4", 40#	1000/bdl.
132012485	81248	16 lb., 7 3/4" x 4 13/16" x 16", 40#	500/bdl.
13200040	80968	16 lb., 7 3/4" x 4 13/16" x 16", 40#	1000/bdl.
13200041	80969	20 lb., 8 1/4" x 5 5/16" x 16 1/8", 40#	1000/bdl.
13200970	80970	25 lb. Shorty, 8 1/4" x 6 1/8" x 15 7/8", 40#	1000/bdl.

B. ELEPHANT® BULWARK

EXTRA HEAVY-DUTY GROCERY BAGS

DURO BAG

Extra heavy-duty kraft grocery bags.

13200094	80038	4 lb., 50#	2000/bdl.
13200095	80039	5 lb., 50#	2000/bdl.
13200099	80040	6 lb., 50#	1000/bdl.
13200098	80041	8 lb., 60#	1000/bdl.
13200104	80042	10 lb., 60#	1000/bdl.
13201112	80043	12 lb., 60#	1000/bdl.
13209004	80044	16 lb., 60#	500/bdl.
13208114	81014	12 lb., 60#	500/bdl.
13201114	80045	20 lb., 60#	500/bdl.
13209129	80046	20 lb. Shorty, 60#	500/bdl.
13200062	80048	25 lb. Shorty, 60#	500/bdl.



BAGS

Grocery/Beer/Liquor/Merchandise/Handle Bags

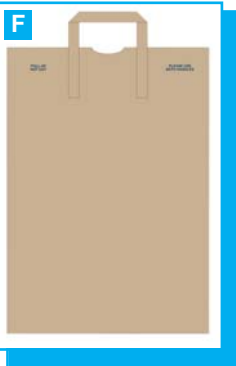

A. LION® HUSKY GROCERY BAGS DURO BAG

Heavy-duty, 50# natural grocery bags.

13208000	80061	8 lb.	1000/bdl.
13201159	81158	12 lb. Shorty	500/bdl.
13208600	80064	16 lb. Shorty	500/bdl.
13208621	80066	20 lb. Shorty	500/bdl.
13201111	80068	25 lb. Shorty	500/bdl.

B. BARREL SACKS DURO BAG

Strong paper barrel sacks. Put your confidence in the strength of Duro sacks.

13203011	81186	9 ³ / ₄ " x 6 ¹ / ₄ " x 16 ³ / ₈ ", 1/8 Tall, 52#	500/bdl.
132012255	81187	9 ³ / ₄ " x 6 ¹ / ₄ " x 16 ³ / ₈ ", 1/8 Tall, 57#	500/bdl.
13200049	80082	10 ¹ / ₈ " x 6 ³ / ₄ " x 14 ³ / ₈ ", 1/8 Short, 52#	500/bdl.
132000515	80083	10 ¹ / ₈ " x 6 ³ / ₄ " x 14 ³ / ₈ ", 1/8 Short, 57#	500/bdl.
13200058	80091	12" x 7" x 17", 1/6, 40/40# Duplex	400/bdl.
13200053	80075	12" x 7" x 17", 1/6, 52#	500/bdl.
132000595	80076	12" x 7" x 17", 1/6, 57#	500/bdl.
132000555	80078	12" x 7" x 17", 1/6, 66#	500/bdl.
13200056	80080	12" x 7" x 17", 1/6, 76#	400/bdl.
13201211	80071	12" x 7" x 21 ³ / ₄ ", 1/4 Tuff, 66#	250/bdl.
13204045	84045	12" x 7" x 21 ³ / ₄ ", 1/4, SOS, 65#	250/bdl.

BEER/LIQUOR BAGS

C. BEER BAG DURO BAG

Paper beer bag. Duro Bags fit any size party.

13200295	8165	25 lb. Shorty, 8 ¹ / ₄ " x 6 ¹ / ₈ " x 15 ⁷ / ₈ ", 65#	500/bdl.
----------	------	--	----------

D. LIQUOR BAGS DURO BAG

Paper liquor bags. Duro Bags fit any size party. Natural kraft.

13201056	81056	1 Pint, 3 ³ / ₄ " x 2 ¹ / ₄ " x 11 ¹ / ₂ "	4000/bdl.
13201527	81527	1 Quart, 4 ¹ / ₂ " x 2 ¹ / ₂ " x 16"	500/bdl.
13200000	80218	1 Quart, 4 ¹ / ₂ " x 2 ¹ / ₂ " x 16"	2000/bdl.

MERCHANDISE/HANDLE BAGS

E. PRIME SOURCE® SHOPPING BAGS PRIME SOURCE®

Eco-friendly reusable fabric shopping bags. These attractive, long-lasting, non-woven shopping bags folds into a compact 7" x 6¹/₂" pack, making it easy to carry when you shop. Perfect for customer shopping needs.

76008624	76008624	13 ¹ / ₂ " x 16 ¹ / ₂ " x 15", Black	100/bdl.
76008620	76008620	13 ¹ / ₂ " x 16 ¹ / ₂ " x 15", Green	100/bdl.
76008622	76008622	13 ¹ / ₂ " x 16 ¹ / ₂ " x 15", Navy	100/bdl.
76008621	76008621	13 ¹ / ₂ " x 16 ¹ / ₂ " x 15", Red	100/bdl.
76008623	76008623	13 ¹ / ₂ " x 16 ¹ / ₂ " x 15", Yellow	100/bdl.

F. HANDLED SACK AJM PACKAGING

Kraft handled sack.

10100575	GS57NP5C	1/6 BBL, 57#	500/bdl.
----------	----------	--------------	----------

G. HANDLE BAG DURO BAG

With wide, stand-up handles and longer adhesive attaching strips, this handle-up bag is stronger, more durable, and more comfortable to use. And with superior custom printing in up to three colors on four sides, your message will really stand out. Handle bags are offered in kraft and white paper in a variety of sizes, and a handle-down style is also available.

13208888	88885	12" x 7" x 17", 1/6, Thank You, 70#	300/bdl.
----------	-------	-------------------------------------	----------

Merchandise/Drawtape/Unprinted Paper Bags



A. MERCHANDISE BAGS

DURO BAG

With its pinch-bottom design, Duro's merchandise bags can be found in retail and specialty stores everywhere, from pharmacies to gift shops to boutiques. Can be printed in up to four colors on all sides. 30# paper. Natural color.

13200043	80193	5" x 7 1/2"	8000/bdl.
13200001	80201	6 1/4" x 9 1/4"	6000/bdl.
13200002	80221	8 1/2" x 11"	4000/bdl.
13200233	80233	10" x 13"	2000/bdl.
13201101	80243	12" x 15"	2000/bdl.
13200004	80279	12" x 3" x 18"	1000/bdl.
13200273	80273	15" x 18"	1000/bdl.
13200073	80288	17" x 21"	1000/bdl.
13200048	80293	14" x 3" x 21"	1000/bdl.
13200006	80304	17" x 4" x 24"	500/bdl.



B. SHOPPING BAGS

DURO BAG

Whatever you're selling, food, clothing, shoes, hardware, novelties, or you-name-it, Duro has the bag to meet all of your packaging needs. We offer a tremendous variety of styles, papers, handles and coatings, and our bags come in a wide array of sizes.

132010015	80695	13" x 7" x 17", Super Mart, Natural, 65#	250/bdl.
13200775	80775	13" x 7" x 17", Super Mart, White, 65#	250/bdl.
13205925	85925	14" x 10" x 15 3/4", Super Royal, Natural, 70#	200/bdl.
13200438	85934	14" x 10" x 15 3/4", Super Royal, White, 70#	200/bdl.



DRAWTAPE BAGS

C. PRIME SOURCE® DRAWTAPE BAGS

PRIME SOURCE®

Plain bags with drawtape closure.

76000721	76000721	18" x 21", White/Red	400/cs.
76000722	76000722	19" x 20", Black/White	400/cs.
Bag with drawtape closure and printed with message.			
76000963	76000963	19" x 20", White/Green, Please Recycle	400/cs.

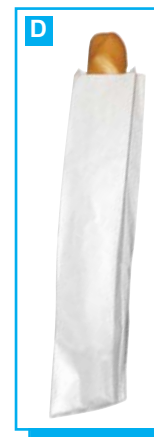
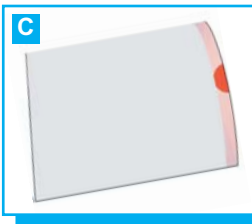

UNPRINTED PAPER BAGS

D. BREAD BAGS

BAGCRAFT/PAPERCON

Paper bread bags with pinch bottoms. White

10900160	300160	4 1/2" x 2 1/2" x 24"	1000/cs.
10900164	300164	5 1/4" x 3 1/4" x 18"	1000/cs.



E. COFFEE BAG

BAGCRAFT/PAPERCON

Auto duplex coffee bag with tin tie. Pasted bottom and polypropylene liner. Natural kraft.

10909713	300950	1/2 lb., 3 3/8" x 2 1/2" x 7 3/4"	1000/cs.
----------	--------	-----------------------------------	----------



F. DRY WAX HOT DOG BAG

BAGCRAFT/PAPERCON

Dry wax hot dog bag. White.

10907904	300440	3 1/2" x 1 1/2" x 8 1/2"	6000/cs.
----------	--------	--------------------------	----------



G. FRENCH FRY BAGS

BAGCRAFT/PAPERCON

Grease resistant french fry bags. White.

16400019	450003	4 1/2" x 3 1/2"	2000/cs.
16400104	450009	5 1/2" x 4 1/2"	2000/cs.



H. DUBL-WAX® CARRYOUT BAGS

BAGCRAFT/PAPERCON

Preserves freshness while still allowing baked foods to breathe. Bright white paper waxed on both sides by special process. SOS automatic bottom style.

10907622	300294	4 lb.	1000/cs.
10907625	300296	6 lb.	1000/cs.
10907628	300298	8 lb.	1000/cs.
10902920	300292	12 lb.	1000/cs.

Unprinted & Printed Paper Bags



BAGS



A. ECOCRAFT® SANDWICH BAGS BAGCRAFT/PAPERCON

Less mess with grease resistant paper. Hot or cold applications and microwaveable. Easy-to-eat convenience for single portions.

10903003	300100	6 1/2" x 1" x 8", #25, Natural Kraft	2000/cs.
16400100	300100	6 1/2" x 1" x 8", #25, Natural Kraft	4000/cs.

B. GREASE-RESISTANT SANDWICH BAGS BAGCRAFT/PAPERCON

Grease resistant sandwich bags.

10900495	300405	6" x 6 1/2", White	2000/cs.
10900494	300418	7" x 6 1/4", White, Open Top & Side	2000/cs.

C. OPEN SESAME® SANDWICH BAG BAGCRAFT/PAPERCON

Open top and sides for fast loading and easy eating. Dry wax paper material.

10903498	03498	7" x 6 3/4", White	2000/cs.
-----------------	-------	--------------------	----------

D. SANDWICH BAG BAGCRAFT/PAPERCON

A strong, plain, grease-resistant sandwich bag.

16401019	450019	6" x 3 1/4" x 7 1/4", White	2000/cs.
-----------------	--------	-----------------------------	----------

E. WET WAX SANDWICH BAG BAGCRAFT/PAPERCON

Transparent wet wax sandwich bag.

109004045	300404	6" x 1 1/10" x 7"	1000/cs.
------------------	--------	-------------------	----------

F. SILVERWARE BAG BAGCRAFT/PAPERCON

Unprinted kraft silverware bag.

10900039	300039	2 3/4" x 10", White	2000/cs.
-----------------	--------	---------------------	----------

G. STAND UP WINDOW BAG BAGCRAFT/PAPERCON

Kraft auto duplex window bag. Stain resistant paper, polypropylene liner and tin tie.

10900250	300250	1 lb., White	500/cs.
-----------------	--------	--------------	---------

PRINTED PAPER BAGS

H. BAKERY BAGS PRIME SOURCE®

Printed waxed bags.

77002004	77002004	4 lb., Our Bakery	500/cs.
77002006	77002006	6 lb., Our Bakery	500/cs.
77002008	77002008	8 lb., Our Bakery	500/cs.
77002012	77002012	12 lb., Our Bakery	500/cs.

I. DUBL PANEL® BREAD BAGS W/WINDOWS BAGCRAFT/PAPERCON

Crispy crusts stay fresh without becoming soggy. Perforated film window for clear visibility.

Pinch bottom style. Natural kraft printed with wheat design.

10903883	300883	3 1/2" x 2" x 26", "Crispy Crust Baguette"	500/cs.
10900882	300882	6 1/2" x 3" x 21", "Crispy Crust"	500/cs.

J. DUBL PANEL® WINDOW BAGS BAGCRAFT/PAPERCON

Sealing Strip™ closure system for safe sealing with any tape or label. Film window for clear visibility. Pinch bottom design. Waxed natural kraft printed with wheat design.

10900886	300886	6 1/2" x 2" x 17 3/4"	1000/cs.
10900887	300887	8" x 3 1/2" x 12 3/4"	500/cs.

K. SUBMARINE SANDWICH BAG BAGCRAFT/PAPERCON

Grease resistant paper provides stain protection.

10900445	300435	4 1/2" x 2" x 14", Stock Design	1000/cs.
-----------------	--------	---------------------------------	----------

Printed Paper Bags/Foil Bags/Poly Bakery Bags



A. POPCORN BAG BAGCRAFT/PAPERCON

Economical and sustainable alternative to cartons and tubs.
10901471 300471 1 lb., Clown Print 1000/cs.



B. TO GO BAGS™ STAND UP AUTO DUPLEX TO GO BAGS BAGCRAFT/PAPERCON

Special moisture and grease resistant white kraft paper two-ply construction. Vented.
10900566 300566 5 1/2" x 3 1/4" x 8 5/8", Red/Black 500/cs.
10908520 300568 8 3/4" x 5 1/4" x 10 3/4", Red/Black 250/cs.
10900113 300569 8 3/4" x 5 1/4" x 12", Red/Black 250/cs.



C. TO GO BAGS™ STAND UP SINGLE WALL TO GO BAG BAGCRAFT/PAPERCON

Special moisture and grease resistant white kraft paper. Replace tubs, barns and cartons.
10901001 300565 5 lb., Red/Black, ZZip Strip™ 500/cs.



FOIL BAGS

D. BRUSHSTROKE™ FOIL SANDWICH BAGS BAGCRAFT/PAPERCON

Foil solid laminated to paper.
10901527 300527 6" x 3/4" x 6 1/2", Red, Hamburger 1000/cs.
10901529 300529 6" x 3/4" x 6 1/2", Yellow, Cheeseburger 1000/cs.

E. HONEYCOMB™ FOIL SANDWICH BAG BAGCRAFT/PAPERCON

Foil Honeycomb™ pattern laminated to paper.
10901524 300524 6" x 3/4" x 6 1/2", Yellow, Cheeseburger 1000/cs.



F. ECOCRAFT® FOIL BREAD BAG BAGCRAFT/PAPERCON

Garlic bread bag lined with unbleached paper. Allows bread to breathe ensuring crispy crust. Right-size package reduces cost. Designed for fresh eye-catching appeal.
10900909 300861 5 1/4" x 3 1/4" x 20", Artisan Design 500/cs.



G. FLAME PAK FOIL INSULATOR CARRYOUT BAGS BAGCRAFT/PAPERCON

Foil insulator pinch bottom carryout bags with printed design. White kraft paper laminated to foil liner. Provides heat and moisture protection.
10900481 300481 1 qt., 5 1/4" x 3 1/2" x 12" 1000/cs.
10908516 300502 1/2 gal., 6" x 4 3/4" x 14" 500/cs.



H. HOT DOG BAG BAGCRAFT/PAPERCON

Foil and paper lamination improves heat retention.
10900455 300455 3 1/2" x 1 1/2" x 8 1/2" 1000/cs.



POLY BAKERY/BREAD BAGS

I. PRIME SOURCE® BAKERY BAGS PRIME SOURCE®

Polypropylene			
76000130	76000130	5 1/2" x 3" x 24"	1000/cs.
76000149	76000149	5 1/2" x 4" x 29"	1000/cs.
76000146	76000146	5 1/2" x 4 3/4" x 16"	1000/cs.
76000395	76000395	5 1/2" x 4 3/4" x 15"	1000/cs.
76000387	76000387	5 1/2" x 4 3/4" x 19"	1000/cs.
76000153	76000153	8" x 6" x 18", 0.90 MIL	500/cs.
62423204	62423204	9" x 18" +4	1000/cs.
76002884	76002884	9" x 28 1/2" + 3"	1000/cs.
76000133	76000133	10" x 8" x 24"	500/cs.
62423200	62423200	12" x 16" +4	1000/cs.
62420041	62420041	12" x 20" +4	1000/cs.
Polyethylene			
76001304	76001304	9" x 15" +1 1/2 Lip, Clear	1000/cs.
76001306	76001306	12" x 6" x 24", White	500/cs.



BAGS

Poly Bakery/Bread/Food/Utility Bags



A. PRIME SOURCE® PRINTED BAKERY BAGS PRIME SOURCE®

Printed high density pinch bottom bakery bags. Transparent.

77002104	77002104	4 lb., Our Bakery	500/cs.
77002108	77002108	8 lb., 6" x 4" x 14", Our Bakery	500/cs.
77002112	77002112	12 lb., 7½" x 4" x 17", Our Bakery	500/cs.

Printed bakery bag.

77003102	77003102	10¼" x 8¼", Our Bakery	2000/cs.
----------	----------	------------------------	----------



B. PRIME SOURCE® BREAD BAGS PRIME SOURCE®

Poly bread bags.

76000150	76000150	5½" x 4¾" x 20", Clear	1000/cs.
75000060	75000060	6½" x 29¼", French	1000/cs.
76000890	76000890	8" x 22" +3, Clear	1000/cs.
75000059	75000059	8¾" x 21", Italian	1000/cs.
76000889	76000889	9" x 13" +4, Clear	1000/cs.
76000954	76000954	9½" x 16" +4, Clear	1000/cs.
76000891	76000891	15" x 22" +4, Clear	1000/cs.
76000936	76000936	12" x 16" +4, Clear	1000/cs.



C. BAKERY BAG FORTUNE PLASTICS

Non-perforated poly bakery bag.

13800002	160NP	5½" x 3" x 24", Clear	1000/cs.
----------	-------	-----------------------	----------



D. BUN PAN COVERS FORTUNE PLASTICS

Bun pan covers on a roll in dispenser box.

13801815	D2135	21" x 6" x 35"	200/cs.
----------	-------	----------------	---------



E. BAKERY BAGS SANECK

Polypropylene bakery bags.

62424382	733022	6" x 3½" x 16", Clear, Wicketed	1000/cs.
624201623	735181	11" x 16" +2, Clear, Wicketed	1000/cs.

POLY FOOD/UTILITY BAGS



F. FRESHPAK® VACUUM POUCHES PRIME SOURCE®

High performance film. Excellent optics. Easy-to-seal. Higher puncture resistance and better machine performance.

75840155	06123	6" x 12"	1000/cs.
75840162	08103	8" x 10"	1000/cs.
75001829	75001829	8" x 10"	1000/cs.
75001830	75001830	8" x 12"	1000/cs.
75001838	75001838	10" x 13"	1000/cs.
75001854	75001854	12" x 16"	500/cs.
75001855	75001855	12" x 18"	500/cs.



G. PRIME SOURCE® DELI POUCH PRIME SOURCE®

Poly deli bag.

77003101	77003101	8½" x 8", Our Deli	2000/cs.
----------	----------	--------------------	----------



H. PRIME SOURCE® FOOD BAGS PRIME SOURCE®

Constructed of clear, linear, low density polyethylene. Provides excellent clarity of product.

76000660	76000660	5" x 4" x 24"	1000/cs.
76000152	76000152	5½" x 4¾" x 28"	1000/cs.
76000204	76000204	6" x 3" x 15"	1000/cs.

Poly Food/Utility Bags



A. PRIME SOURCE® HEADER BAG SANECK

Printed poly header bag.
62429757 62429757 10" x 15", Fresh Catch 1800/cs.



B. PRIME SOURCE® MEAT & POULTRY BAGS PRIME SOURCE®

Non-perforated, polypropylene meat and poultry bags. Clear.

76000132	76000132	4" x 2" x 8", 0.52 MIL	1000/cs.
76000418	76000418	4" x 2" x 12", 0.52 MIL	1000/cs.
76000141	76000141	6" x 3" x 12", 0.65 MIL	1000/cs.
76000135	76000135	6" x 3" x 15", 0.70 MIL	1000/cs.
76000142	76000142	8" x 3" x 15", 0.70 MIL	1000/cs.
76000402	76000402	8" x 4" x 18", 0.60 MIL	1000/cs.
76000139	76000139	10" x 4" x 20", 0.76 MIL	1000/cs.
76000405	76000405	10" x 8" x 24", 0.80 MIL	500/cs.



C. PRIME SOURCE® POLY BAGS PRIME SOURCE®

Polypropylene bags. Non-perforated. Clear.

76000437	76000437	5" x 4 1/2" x 15", 0.90 MIL	1000/cs.
76000151	76000151	5 1/2" x 3" x 24", 1.0 MIL	1000/cs.
76000432	76000432	6" x 3" x 12", 1.0 MIL	1000/cs.
76000147	76000147	6" x 3" x 15", 1.0 MIL	1000/cs.
76000208	76000208	8" x 4" x 18", 1.0 MIL	1000/cs.
76000434	76000434	8" x 4" x 18", 1.0 MIL	1000/cs.
76000435	76000435	8" x 4" x 18", 1.50 MIL	500/cs.
76007817	76007817	8" x 4" x 18", 2.0 MIL	1000/cs.
76000145	76000145	12" x 6" x 24", 2.0 MIL	500/cs.
75000064	75000064	14" x 26" +1/4 Lip, 0.90 MIL	500/cs.
76000018	76000018	24" x 24", 8 MIC	1000/cs.



D. PRIME SOURCE® POLY FOOD BAGS PRIME SOURCE®

Constructed of clear, linear, low density polyethylene. Provides excellent clarity of product.

76000200	76000200	4" x 2" x 8"	1000/cs.
76001509	76001509	4" x 2" x 12", Regular	1000/cs.
76000662	76000662	6" x 3" x 15", Mediumweight	1000/cs.
76000663	76000663	6" x 3 1/2" x 18", Mediumweight	1000/cs.
76000664	76000664	7" x 6" x 15", Regular	1000/cs.
76000665	76000665	8" x 3" x 15", Mediumweight	1000/cs.
76000666	76000666	8" x 4" x 18", Regular	1000/cs.
76000207	76000207	8" x 4" x 18"	1000/cs.
76000667	76000667	8" x 4" x 18", X-Heavyweight	1000/cs.
76000206	76000206	10" x 8" x 24"	500/cs.
76000201	76000201	10" x 8" x 24", Heavyweight	500/cs.



E. PRIME SOURCE® POULTRY BAGS PRIME SOURCE®

Non-perforated poly poultry bags.

76000397	76000397	6" x 3" x 15", Heavyweight	1000/cs.
76000409	76000409	8" x 4" x 18", 1.75 MIL	500/cs.
76000148	76000148	8" x 4" x 18", 2.0 MIL	500/cs.
76000144	76000144	12" x 8" x 30", 1.0 MIL	500/cs.



F. PRIME SOURCE® SEAFOOD BAG PRIME SOURCE®

High density polyethylene.

75000058	75000058	7 1/2" x 4" x 12", 0.95 MIL	1000/cs.
----------	----------	-----------------------------	----------



G. PRIME SOURCE® SNAP OFF BAGS PRIME SOURCE®

Snap off bags with ties.

76000406	76000406	10" x 14", 0.65 MIL	1000/cs.
76000407	76000407	21" x 35", 0.90 MIL	200/cs.



BAGS

Poly Food/Utility/Produce/Sandwich Bags



A. FOOD/UTILITY BAGS FORTUNE PLASTICS

Poly food bags. Clear.

13800150	100NP	4" x 2" x 8"	1000/cs.
13807305	101NP	4" x 2" x 12"	1000/cs.
13801065	109NP	6" x 3" x 12"	1000/cs.
13801105	127NP	8" x 4" x 18"	1000/cs.
13801110	127NPM	8" x 4" x 18", Medium	1000/cs.
13801115	127NPH	8" x 4" x 18", Heavy	1000/cs.
13801150	130NP	10" x 4" x 20"	1000/cs.



B. POLY BAGS FORTUNE PLASTICS

Linear low density poly bags.

13800029	91380023	8" x 4" x 26", Clear, Ribs	500/cs.
13805300	12205SW	12" x 20 1/2" +3, Clear, Wicketed	1000/cs.

POLY PRODUCE BAGS



C. PRIME SOURCE® PRODUCE BAG PRIME SOURCE®

Clear produce bag.

75000066	75000066	15" x 19"	2000/cs.
----------	----------	-----------	----------



D. PRIME SOURCE® PRODUCE BAGS PRIME SOURCE®

Constructed of linear, low density polyethylene. Provides excellent clarity of product.

76000392	76000392	8" x 3" x 20", Clear	1000/cs.
76001623	76001623	16" x 23" +1.5, Clear, Wicketed, 1 MIL	500/cs.

E. PRIME SOURCE® PRODUCE ROLL BAGS PRIME SOURCE®

Heavy PTO Roll Bags

76001826	76001826	12" x 17", 10 MIC	4360/cs.
76001827	76001827	14" x 24", 9 MIC	4000/cs.

With Ties

76001825	76001825	6" x 8", 0.85 MIL	2000/cs.
76001824	76001824	18" x 24", 0.85 MIL	250/cs.



F. PLANT SLEEVES SANECK

Printed florist shop plant sleeves.

62422554	62422554	Stock Print	5/100/cs.
62422543	62422554	Stock Print	500/cs.



POLY SANDWICH BAGS



G. PRIME SOURCE® SANDWICH BAGS PRIME SOURCE®

Flip top sandwich bags.

76000600	76000600	6 3/4" x 6 3/4" x 1"	6M/cs.
760006005	76000600	6 3/4" x 6 3/4" x 1"	2000/bx.
76009000	76009000	7" x 7 +1 1/2", .7 MIL	2000/cs.

H. PRIME SOURCE® SUB SANDWICH BAGS PRIME SOURCE®

Poly sub sandwich bags.

76001030	76001030	9 1/2" x 7" +3	1000/cs.
76001029	76001029	15" x 7" +3	1000/cs.



Ice/T-Shirt/Tote Bags

ICE BAGS

A. PRIME SOURCE® ICE BAGS

PRIME SOURCE®

Freezer-safe, clear polyethylene ice bags are resistant to punctures, rips and tears. Optional drawstrings seal bags easily and securely.

Standard Bags

76000019	76000019	7" x 4" x 24", Clear	1000/cs.
75001776	75001776	8 lb., 8" x 3" x 20", 1 Color Print	1000/cs.
75001777	75001777	8 lb., 8" x 3" x 20", 3 Color Print	1000/cs.
75001780	75001780	10 lb., 8" x 4" x 22", 1 Color Print	1000/cs.
75001781	75001781	10 lb., 8" x 4" x 22", 3 Color Print	1000/cs.

Drawstring Bags

75001778	75001778	8 lb., 8" x 3" x 20", 1 Color Print	500/cs.
75001779	75001779	8 lb., 8" x 3" x 20", 3 Color Print	500/cs.
75001782	75001782	10 lb., 8" x 4" x 22", 1 Color Print	500/cs.
75001783	75001783	10 lb., 8" x 4" x 22", 3 Color Print	500/cs.



B. ICE BAGS

FORTUNE PLASTICS

Printed low density flat ice bags.

13802112	IC10	10 lb., 12" x 21"	1000/cs.
13800048	IC25W	25 lb., 14" x 28"	100/cs.



T-SHIRT/TOTE BAGS

C. PRIME SOURCE® MINITOTE BAG

PRIME SOURCE®

High density minitote bag.

76000016	76000016	20 lb., White	1000/cs.
----------	----------	---------------	----------



D. PRIME SOURCE® T-SACKS

PRIME SOURCE®

Poly t-sacks. 1/6 BBL.

75001312	75001312	11" x 7" x 21", White, Thank You	850/cs.
75001313	75001313	11" x 7" x 21", White/Red, Thank You	900/cs.
75001311	75001311	11" x 7" x 21", White/Red, Thank You	1000/cs.
76000001	76000001	12" x 7" x 23", Smiley Face, 17.5 MIC	500/cs.



E. HIPPO SAKS®

CROWN POLY

The invincible grocery bags with the strength of paper and the ease of plastic. Hippo Ties™ prevent bag contents from spilling over in the car. Wider and thicker Hippo Handles are more comfortable to carry. Reinforced bottom seals - Hippo Strips™ eliminate weak stress points.

Hippo 8 Bags

28168113	T80013	12 1/2" x 7 1/2" x 20 3/8", Natural, 13.5 MIC, HMW - HDPE & LLDPE	1400/cs.
28160051	T89999	12 1/2" x 7 1/2" x 20 3/8", Green, Eco, 15.5 MIC, 100% Post Industrial Recycled Resin	1300/cs.

Hippo 12 Bags

28160373	T30373	12 1/2" x 7 1/2" x 24", White, Thank You, 13.5 MIC, HMW - HDPE & LLDPE	1300/cs.
28168013	T38013	12 1/2" x 7 1/2" x 24", Natural, Enviro, 13.5 MIC, HMW - HDPE & LLDPE	1300/cs.
28168015	T38015	12 1/2" x 7 1/2" x 24", Natural, Enviro, 15.5 MIC, HMW - HDPE & LLDPE	1100/cs.
28168017	T38017	12 1/2" x 7 1/2" x 24", Natural, Enviro, 17.5 MIC, HMW - HDPE & LLDPE	1000/cs.
28169999	T39999	12 1/2" x 7 1/2" x 24", Green, Eco, 16.5 MIC, 100% Post Industrial Recycled Resin	1050/cs.



F. QUIKMATE EZ® T-SHIRT BAG

HILEX POLY

Engineered convenient T-shirt bag style with integrated tabs. Sizes to fit any purchase requirements. Patented easy-open design. Hardware to fit almost any check stand configuration. Dispensing systems, including racks, trays and rolls designed for maximum checkout productivity.

18302101	4000001	1/6, 12" x 7" x 22", 13 MIC, Thank You/Gray Is The New Green	1000/cs.
----------	---------	--	----------



BAGS

Zip Closure Bags

ZIP CLOSURE BAGS



A. OUR DELI® DELI BAGS PRIME SOURCE®

Easy-to-use with a secure reclosable slidlock closure.

75001310	75001310	10" x 8", Flat Bag	1000/cs.
75001302	75001302	10½" x 8", Saddle Pack	1000/cs.
Bottom load deli bag.			
75001341	75001341	10" x 8"	1000/cs.
Reclosable deli bag. Saddle pack.			
75003002	75003002	10" x 8¼"	1000/cs.

B. PRIME SOURCE® RECLOSABLE BAG PRIME SOURCE®

Low density polyethylene.

75001844	75001844	4" x 4", Clear, 2 MIL	1000/cs.
-----------------	----------	-----------------------	----------

C. PRIME SOURCE® SLIDER BAGS PRIME SOURCE®

Polyethylene slider bags.

75001849	75001849	10" x 7", Clear, 3 MIL	250/cs.
75001847	75001847	12" x 12", Clear, 2 MIL	500/cs.
75001846	75001846	15" x 16", Clear, 2 MIL	500/cs.
76007818	76007818	15" x 16", Clear, 3 MIL	500/cs.
Printed poly slider deli bags.			
76001543	76001543	8½" x 11", 3-Color Print	1000/cs.
75000023	75000023	10½" x 8", Fresh From Our Deli	2000/cs.

D. PRIME SOURCE® ZIPLOCK BAGS PRIME SOURCE®

Poly ziplock bags.

76000438	76000438	5" x 8", Clear	1000/cs.
76000440	76000440	8" x 10", Clear	1000/cs.
76000527	76000527	8" x 10½", Deli Fresh	1000/cs.
76004527	76004527	9½" x 10½" +5, Deli Fresh	2000/cs.
76000441	76000441	10" x 12", Clear	1000/cs.

E. GLAD® ZIPPER SANDWICH BAG CLOROX

Ideal for packing favorite lunch sandwiches and snacks, or storing small amounts of leftovers in the fridge. Designed to have a watertight seal.

38386006	60062	1.15 MIL	12/cs.
-----------------	-------	----------	--------

F. GLAD® ZIPPER STORAGE BAG CLOROX

Seal in freshness and protect your food. Bags have the yellow-and-blue-make-Green Seal®, when you see the Green Seal®, you know the bag is closed. Kosher.

38381271	60032	1 gal., 40 ct.	9/cs.
-----------------	-------	----------------	-------

G. ZIPLOC® BAGS DIVERSEY

The trusted name in food storage, are available in convenient, economical, food service size packs. Ziploc® brand bags are strong and reliable. Ideal for keeping food fresh, clean and delicious in foodservice operations.

Sandwich Bags

15200390	CB003905	12/50 ct. Retail Pack	600/cs.
15200058	94600	500 ct.	500/cs.
Freezer Bags			
15203816	CB003813	1 qt., 9/40 ct. Retail Pack	360/cs.
15200063	94604	1 gal.	250/cs.
15204605	94605	2 gal.	100/cs.
Storage Bags			
15200059	94601	1 qt.	500/cs.
15200060	94602	1 gal.	250/cs.
15200062	94603	2 gal.	100/cs.

BAGS

Zip Closure Bags/Pan Rack Cover

A. QWIK SEAL® RECLOSABLE FOODSERVICE BAGS

REYNOLDS® FOOD PACKAGING

Save time and space with these unique bags. Triple track seal locks in freshness quickly and securely. These versatile, clear bags are ideal for space-saving storage, no-leak transport and smooth service and can be stacked without fear of bursting. The self-dispensing carton makes them easy to use for take-home foods, bulk foods and over-the-counter sales.

17306500	<i>RS65</i>	Sandwich, 6 ⁵ / ₈ " x 5 ⁷ / ₈ ", 1.15 MIL	500/cs.
17307800	<i>RS78</i>	1 qt., 7" x 8", 1.75 MIL	500/cs.
17301400	<i>RS1011</i>	1 gal., 10 ⁹ / ₁₆ " x 11", 1.75 MIL	250/cs.



B. ZIPLOCK BAG

SANECK

Stock poly ziplock bag.

62420095	<i>62420095</i>	10 ¹ / ₂ " x 8", Deli Fresh	1000/cs.
-----------------	-----------------	---	----------



PAN RACK COVER

C. PRIME SOURCE® PAN RACK COVER

PRIME SOURCE®

Poly rack cover.

75001750	<i>75001750</i>	52" x 80"	50/cs.
-----------------	-----------------	-----------	--------



Paper Rolls



PAPER ROLLS

A. BUTCHER PAPER

PRIME SOURCE®

Highweight butcher paper for extra strength.

75003916	75003916	15" x 1000', White, 40#	1/r.
75003901	75003901	15" x 1100', White, 50#	1/r.
75003911	75003911	15" x 1300', White, 40#	1/r.
75003917	75003917	18" x 1000', White, 40#	1/r.
75003902	75003386	18" x 1100', White, 50#	1/r.
75003912	75003912	18" x 1300', White, 40#	1/r.
75003918	75003918	24" x 1000', White, 40#	1/r.
75003903	75003903	24" x 1100', White, 50#	1/r.
75003904	75003904	30" x 1100', White, 50#	1/r.
75003905	75003905	36" x 1100', White, 50#	1/r.
75003914	75003914	36" x 1300', White, 40#	1/r.

A - B

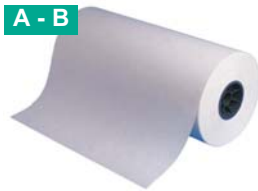

B. FOOD WRAPS

PRIME SOURCE®

Heavyweight.

75003921	75003921	12" x 1000', White, 40#	1/r.
75003923	75003923	15" x 1000', White, 40#	1/r.
75003925	75003925	18" x 1000', White, 40#	1/r.
75003927	75003927	24" x 1000', White, 40#	1/r.
75003929	75003929	30" x 1000', White, 40#	1/r.
75003931	75003931	36" x 1000', White, 40#	1/r.
75003933	75003933	48" x 1000', White, 40#	1/r.

C. FRESHLOC BUTCHER PAPER

BAGCRAFT/PAPERCON

Mediumweight white poly coated freezer paper. FDA, USDA approved.

16405018	135018	18" x 1000'	1/r.
----------	--------	-------------	------

D. KRAFT PAPER

DURO BAG

Kraft paper roll.

13200419	85008	30" x 1200', Kraft	1/r.
----------	-------	--------------------	------

E. FRESHGARD® LOXOL®

FREEZER PAPER

GEORGIA PACIFIC FOODSERVICE

Polyethylene coated freezer paper roll. Average protection, six to nine months.

15000798	FG15	15" x 1100', White	1/r.
15000797	FG18	18" x 1100', White	1/r.
15000819	FG24	24" x 1100', White	1/r.

F. KOLD-LOK® FREEZER PAPER

GEORGIA PACIFIC FOODSERVICE

Lightweight freezer paper for short term (3-6 months) storage and grocery carry-out. The unique base paper, poly coating and added plasticizer provides easy handling and protection against freezer burn.

15002995	KL15	15" x 1100', White	1/r.
15003100	KL18	18" x 1100', White	1/r.
15000024	KL24	24" x 1100', White	1/r.

Safe Handling Design

15001621	18SHCUTS	18" x 1000', Meat	1/r.
15001610	18CATCH	18" x 1000', Seafood	1/r.

G. SUPER LOXOL®

FREEZER PAPER

GEORGIA PACIFIC FOODSERVICE

Heavyweight freezer paper for long term protection (12-15 months), storage and grocery carry-out. The unique base paper, poly coating, and added plasticizer provides easy handling and protection against freezer burn.

15005510	SUPLOX18	18" x 1000', White	1/r.
15000125	SUPLOX24	24" x 1000', White	1/r.

C



D



E



F



G



Steak, Patty & Deli Paper

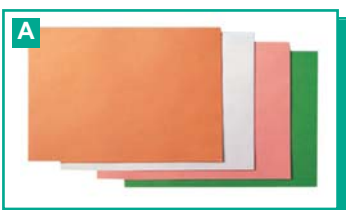

FOODSERVICE PROCESSING, WRAPS & APPAREL

STEAK PAPER

A. STEAK PAPER GEORGIA PACIFIC FOODSERVICE

High quality paper for displaying and interleaving meat and seafood products. Resists staining and soak through. Retards blackening and spoilage.

15001936	<i>GS1030</i>	10" x 30", 1000 ct., Green	1000/cs.
15004611	<i>PH1030</i>	10" x 30", 1000 ct., Peach	1000/cs.
15001940	<i>GS1230</i>	12" x 30", 1000 ct., Green	1000/cs.

PATTY PAPER

B. DISPENS-A-WAX DELIVERY PATTY PAPER GEORGIA PACIFIC FOODSERVICE

Standard grade, dry waxed deli patty paper sheets for food interleaving or as a pick-up sheet.

15006528	434	4 ³ / ₄ " x 5", White	24,000/cs.
15009612	512	5 ¹ / ₂ " x 5 ¹ / ₂ ", White	24,000/cs.
15001526	801200	6" x 6", White	10,000/cs.

C. PATTY PAPER GEORGIA PACIFIC FOODSERVICE

Patty paper roll for interleaving, storing and handling meats and cheeses.

15006520	<i>WR5659</i>	4 ¹ / ₂ " x 4 ¹ / ₂ ", 777 ct., White, 1-Hole Drilled	14,000/cs.
15006508	<i>WR58</i>	5" x 5", 777 ct., White, 1-Hole Drilled	14,000/cs.
15009600	<i>W55</i>	5 ³ / ₁₆ " x 5 ³ / ₁₆ ", 777 ct., White, 3-Hole Drilled	14,000/cs.
15005036	<i>W46</i>	5 ³ / ₁₆ " x 5 ³ / ₁₆ ", 1555 ct., White, 3-Hole Drilled	28,000/cs.

DELI PAPER

D. BASKET LINERS BAGCRAFT/PAPERCON

Economical, microwavable, grease resistant basket liner sheets.

16407700	<i>057700</i>	12" x 12", Red Check	5000/cs.
-----------------	---------------	----------------------	----------

E. BASKET LINERS BAGCRAFT/PAPERCON

Coating over printing protects food from contact with ink.

10900398	<i>300398</i>	12" x 10 ¹ / ₂ ", Red Check	2000/cs.
-----------------	---------------	---	----------

F. DRY WAX SHEETS BAGCRAFT/PAPERCON

Dry waxed paper for wrapping all types of foods. Makes an excellent basket liner, food prep or portion control divider. High wet strength keeps paper intact in all types of applications. Grease and moisture resistant to help ensure product freshness and appearance. Easy release for both fresh and frozen foods. Excellent temperature retention for wrapping hot or cold foods. Convenient pop-up dispenser boxes. FDA approved.

Regular

16400610	<i>011006</i>	6" x 10 ³ / ₄ "	6000/cs.
16400049	<i>011008</i>	8" x 10 ³ / ₄ "	6000/cs.
16401010	<i>011010</i>	10" x 10 ³ / ₄ "	6000/cs.
16400039	<i>011012</i>	12" x 10 ³ / ₄ "	6000/cs.
16409015	<i>011015</i>	15" x 10 ³ / ₄ "	6000/cs.

Heavyweight

16407411	<i>012006</i>	6" x 10 ³ / ₄ "	6000/cs.
16402008	<i>012008</i>	8" x 10 ³ / ₄ "	6000/cs.
16407410	<i>012010</i>	10" x 10 ³ / ₄ "	6000/cs.
16402012	<i>012012</i>	12" x 10 ³ / ₄ "	6000/cs.
16407415	<i>012015</i>	15" x 10 ³ / ₄ "	6000/cs.

G. EASY WRAP SANDWICH WRAPPER BAGCRAFT/PAPERCON

Excellent, flexible protection for hoagies, deli and most cold sandwich products. Grease and stain resistant protection. Excellent moisture barrier.

16404512	<i>057012</i>	12" x 12", White	5000/cs.
16401212	<i>057412</i>	12" x 12", Yellow	5000/cs.
16400008	<i>057014</i>	14" x 14", White	4000/cs.
16400007	<i>057015</i>	15" x 16", White	3000/cs.

Deli Paper



FOODSERVICE PROCESSING, WRAPS & APPAREL

A. ECOCRAFT® DELI WRAPS BAGCRAFT/PAPERCON

Grease-resistant multi-purpose sandwich wrap/basket liner. Hot or cold applications and microwaveable. Easy-to-eat convenience for single portions.

16400897	300897	12" x 12", Natural Kraft	5000/cs.
10900881	300899	14" x 14", Natural Kraft	4000/cs.
10906380	300898	15" x 16", Natural Kraft	3000/cs.



B. ECOCRAFT® INTERFOLDED SHEETS BAGCRAFT/PAPERCON

Excellent moisture barrier with soy wax blend. Quick sanitary pick-up and handling. Separates assorted baked and deli goods. Easy release fresh or frozen.

16401001	010001	6" x 10 ³ / ₄ ", Natural Kraft	10,000/cs.
16401608	016008	8" x 10 ³ / ₄ ", Natural Kraft	6000/cs.
16401601	016010	10" x 10 ³ / ₄ ", Natural Kraft	6000/cs.
16406012	016012	12" x 10 ³ / ₄ ", Natural Kraft	6000/cs.



C. INSULATED PAPER WRAP BAGCRAFT/PAPERCON

Paper/polyethylene/paper lamination. Microwaveable.

10900343	300343	12" x 12", White	2000/cs.
----------	--------	------------------	----------



D. SANDWICH TISSUE BAGCRAFT/PAPERCON

Lightweight with excellent wet strength.

16409121	059121	12" x 12", White	10,000/cs.
----------	--------	------------------	------------

E. SANDWICH WRAP BAGCRAFT/PAPERCON

Dry wax sandwich wrap.

16404016	054016	16" x 16", White	3000/cs.
----------	--------	------------------	----------



F. MENU® TISSUE SANDWICH WRAP GEORGIA PACIFIC FOODSERVICE

Versatile untreated tissue paper for lightweight food handling duty.

15000491	862491	12" x 12", White	10,000/cs.
----------	--------	------------------	------------



G. GLENVALE® INTERFOLDED DELI PAPER GEORGIA PACIFIC FOODSERVICE

All purpose, standard weight, dry waxed deli paper for food handling needs.

15001205	G6	6" x 10 ³ / ₄ ", White	6000/cs.
15000810	G8	8" x 10 ³ / ₄ ", 500 ct., White	6000/cs.
15001915	G10	10" x 10 ³ / ₄ ", 500 ct., White	6000/cs.
15001210	G12	12" x 10 ³ / ₄ ", 500 ct., White	6000/cs.
15009650	G15	15" x 10 ³ / ₄ ", 500 ct., White	6000/cs.



H. KABNET WAX® INTERFOLDED DELI PAPER GEORGIA PACIFIC FOODSERVICE

Heavyweight deli paper with generous dry wax. Wet strength added. Interfolded in attractive dispensing boxes.

15007280	80MIDGET	6" x 10 ³ / ₄ ", White	6000/cs.
15007283	83MASTER	12" x 10 ³ / ₄ ", White	6000/cs.



I. PIZZA SHEETS GEORGIA PACIFIC FOODSERVICE

Genuine parchment silicone treated pizza pan liners for use in pizza ovens to eliminate charring and provide an even browning. In 1000 dispensing cartons.

15000005	27S12	27#, 12" x 12", Silicone	1000/cs.
----------	-------	--------------------------	----------



J. QUIK-RAP® SANDWICH PAPER GEORGIA PACIFIC FOODSERVICE

Economical grease resistant sheets can be used as a basket liner and low cost sandwich wrap. Resists soak-through of product juices and condiments. Non-dry waxed. Microwaveable. Will not crack under heat. FDA approved sheets. Allows for attractive custom printing.

15009415	891258	12" x 12", White	5000/cs.
15000515	891254	14" x 14", White	4000/cs.
15005008	891255	15" x 16", White	3000/cs.



Deli Paper/Pan Liners



FOODSERVICE PROCESSING, WRAPS & APPAREL



A. QUILT WRAP SANDWICH PAPER GEORGIA PACIFIC FOODSERVICE

Laminated. Maximizes heat retention, provides superior moisture control and grease absorption, and improves sandwich appearance. Keeps foods from becoming soggy. Food doesn't stick to wrap, causing less mess and food waste.

15000432	LQ1212TOMA	12" x 12", Tomato	1000/cs.
15009850	LQ1212PL	12" x 12", White	2500/cs.

B. RITE WRAP INTERFOLDED DELI PAPER GEORGIA PACIFIC FOODSERVICE

Dry waxed deli paper stays folded, absorbs liquids and keeps food fresh. Wet strength added to hold up in moist conditions. Interfolded in attractive dispensing boxes. Absorbs excess grease and oil while acting as a sanitary barrier for food.

15009645	RW66	6" x 10 ³ / ₄ ", 500 ct., White	6000/cs.
15007000	RW86	8" x 10 ³ / ₄ ", 500 ct., White	6000/cs.
15000017	RW106	10" x 10 ³ / ₄ ", 500 ct., White	6000/cs.
15001305	RW126	12" x 10 ³ / ₄ ", 500 ct., White	6000/cs.
15007227	RW156	15" x 10 ³ / ₄ ", 500 ct., White	6000/cs.

PAN LINERS

C. BAKERY PAN LINER PRIME SOURCE®

A premium coated parchment pan liner ideal for reuse. Kosher and Pareve for year-round use.

75003991	75003991	25#, 16 ³ / ₈ " x 24 ³ / ₈ "	1000/cs.
----------	----------	--	----------

D. PAN LINER PRIME SOURCE®

Quillon-treated kraft pan liner.

75003990	75003990	25#, 16 ³ / ₄ " x 24 ³ / ₈ ", Brown	1000/cs.
----------	----------	---	----------

E. ECO-CRAFT® ARTISAN PAN LINER BAGCRAFT/PAPERCON

EcoCraft® 2-Star pan liners with improved release are unbleached, compostable and biodegradable. Kosher certified (Star K).

10900963	030025	16 ³ / ₈ " x 24 ³ / ₈ ", Unbleached 2-Star	1000/cs.
----------	--------	--	----------

F. ECO-CRAFT® BAKE 'N' REUSE™ PAN LINER BAGCRAFT/PAPERCON

Comparable to a silicone greaseproof baking sheet but without the chromium. It is manufactured from chlorine-free pulp and approved for standard waste disposal. The liners have excellent heat retention for baking of high-moisture items and can be used at temperatures up to 425°F. Chlorine-free pulp, printed, 100% recycled.

16400180	030010	16 ³ / ₈ " x 24 ³ / ₈ ", Medium Temperature	1000/cs.
----------	--------	---	----------

G. PAN LINERS BAGCRAFT/PAPERCON

For all baking and candy needs: cookies, bagels, bread, cakes, danish, rolls, croissants, candies. For more even baking with no scorching. Easy release silicone or quillon treated eliminates pan greasing and cleanup. Reusable for economy. Save warehouse space, disposal costs. Environmentally compatible. Made from 100% biodegradable cellulose fibers, high wet strength for durability. All natural parchment will not contaminate and is completely odorless and tasteless, allowing baked goods and candies to retain their original flavor. Hard pinhole-free surface resists grease, water and oven browning. Convenient 1000 sheet box dispenser. FDA approved and suitable for Kosher foods.

10902700	479668	10" x 16", 27#	1000/cs.
16400003	030005	12 ¹ / ₈ " x 16 ³ / ₈ ", Quillon	2000/cs.

H. PARCHMENT SHEETS BAGCRAFT/PAPERCON

Plain vegetable parchment.

16404013	031121	27#, 12" x 12"	1000/cs.
----------	--------	----------------	----------

Pan Liners/Bakery Tissue/Baking Cups



A. BAK-O-MATIC® PREMIUM PAN LINERS GEORGIA PACIFIC FOODSERVICE

Kosher parchment.

Silicone Coated

15007910	35S	16 ³ / ₈ " x 24 ³ / ₈ ", Blue Label, Parchment	1000/cs.
15000362	27SGP	16 ³ / ₈ " x 24 ³ / ₈ ", Orange Label, Greaseproof	1000/cs.
15002711	27S	16 ³ / ₈ " x 24 ³ / ₈ ", Yellow Label, Parchment	1000/cs.

Quilon Coated

15002001	24Q	16 ³ / ₈ " x 24 ³ / ₈ ", Green Label, Parchment	1000/cs.
----------	-----	---	----------



B. DIXIE® GREASEPROOF PAN LINER GEORGIA PACIFIC FOODSERVICE

Economical release treated single use pan liners for one-time baking use in moderate oven conditions. Certified Kosher and Pareve for Passover use when marked with the Star-K symbol.

15002484	LO10	16 ³ / ₈ " x 24 ³ / ₈ ", White	1000/cs.
----------	------	--	----------



C. FLUTED PAN LINERS GEORGIA PACIFIC FOODSERVICE

Kosher, dry wax treated.

15000822	60BL	7" x 27 ⁷ / ₈ " x 2 ¹ / ₄ ", Oblong, White	2000/cs.
15001310	0110103	7 ³ / ₄ " x 1 ¹ / ₂ " x 8 ¹ / ₂ ", Round	1000/cs.



D. HANDI-SIZE SINGLE USE PAN LINER GEORGIA PACIFIC FOODSERVICE

Greaseproof pan liner. Quilon coated. Kosher.

15002002	HS1000	12 ³ / ₁₆ " x 16 ³ / ₈ ", White	1000/cs.
----------	--------	---	----------



BAKERY TISSUE

E. INTERFOLDED DRY WAX TISSUE BAGCRAFT/PAPERCON

Use for quick, sanitary pick-up and handling of goods from counter to customer or use to separate baked goods. Economical dry waxed paper resists grease and water. Lightweight flexibility protects delicate donuts or sturdy bagels. Convenient interfolded pop-up tissue dispensers.

10908000	010006	6" x 10 ³ / ₄ "	10,000/cs.
16401008	010008	8" x 10 ³ / ₄ "	10,000/cs.
16401012	010012	12" x 10 ³ / ₄ "	6000/cs.
16401033	010015	15" x 10 ³ / ₄ "	6000/cs.



F. TISSUE PAC® BAKERY TISSUE GEORGIA PACIFIC FOODSERVICE

Lightweight, dry waxed tissue interfolded for pop-up convenience. Used for handling baked goods and other food applications without touching the product.

15005810	T6	6" x 10 ³ / ₄ ", 1000 ct., White	10,000/cs.
15009620	T10	10" x 10 ³ / ₄ ", 1000 ct., White	8000/cs.
15005812	T12	12" x 10 ³ / ₄ ", 1000 ct., White	6000/cs.



BAKING CUPS

G. BAKING CUPS GEORGIA PACIFIC FOODSERVICE

Kosher baking cups.

15000904	6X	1 ¹ / ₄ " x 7 ⁷ / ₈ " x 3", White	10,000/cs.
150073605	15CX	2" x 1 ¹ / ₄ " x 4 ¹ / ₂ ", White	500/bx.
15007360	15CX	2" x 1 ¹ / ₄ " x 4 ¹ / ₂ ", White	10,000/cs.
15000903	20CX	2" x 1 ³ / ₈ " x 4 ³ / ₄ ", White	10,000/cs.
15007914	30EX	2 ¹ / ₄ " x 1 ⁷ / ₈ " x 6", White	10,000/cs.
15000076	35PX	3 ¹ / ₂ " x 1 ¹ / ₂ " x 6 ¹ / ₂ ", White	5000/cs.



H. BAKING CUPS REYNOLDS® FOOD PACKAGING

Round baking cups.

17301757	FC125X2938	3", 1 ¹ / ₄ " Bottom, White	10,000/cs.
17301755	150312	3 ¹ / ₂ ", 1 ¹ / ₂ " Bottom x 1" Wall, White	10,000/cs.
17302250	2146	6", 2 ¹ / ₄ " Bottom x 1 ⁷ / ₈ " Wall, White	10,000/cs.

Foil Sheets/Foil Rolls

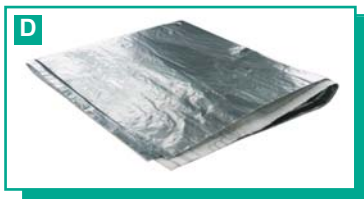
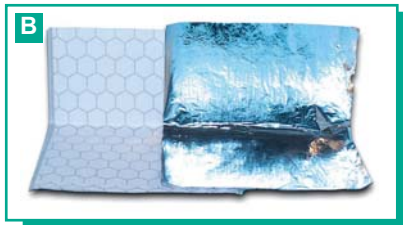

FOIL SHEETS

A. ALUMINUM FOIL POP UP SHEETS PRIME SOURCE®

Perfect for freezing, storing and cooking in the food service industry. Pop-up dispenser box delivers one sheet at a time.

75000950	75000950	9" x 10 ³ / ₄ ", 500 ct.	3000/cs.
75001220	75001220	12" x 12 ³ / ₄ ", 200 ct.	2400/cs.
75001250	75001250	12" x 12 ³ / ₄ ", 500 ct.	3000/cs.
750012505	75001250	12" x 12 ³ / ₄ ", 500 ct.	500/cs.

B. HONEYCOMB™ FOODSERVICE FOIL SHEETS BAGCRAFT/PAPERCON

Exclusive foil/paper lamination retains heat, absorbs steam, resists curl. Excellent deadfold capabilities. Cardboard dispenser keeps sheets flat.

10900816	300815	10 ¹ / ₂ " x 14", Silver	2000/cs.
10900841	300841	14" x 16", Silver, Unprinted	1000/cs.

C. INTERFOLDED QUILTED® FOIL POP-UP SHEETS PACTIV

Ideal for facilitating freezing, storage and cooking in all types of foodservice applications.

16201310	W71	9" x 10 ³ / ₄ ", 200 ct.	2400/cs.
16206580	W73	9" x 10 ³ / ₄ ", 200 ct., Gold	2400/cs.
16206560	W72	9" x 10 ³ / ₄ ", 500 ct.	3000/cs.
16206565	W72BCH	9" x 10 ³ / ₄ ", 500 ct., Blue Cross Hatch	3000/cs.
16206570	W72GCH	9" x 10 ³ / ₄ ", 500 ct., Green Cross Hatch	3000/cs.
16206575	W72RCH	9" x 10 ³ / ₄ ", 500 ct., Red Cross Hatch	3000/cs.
16201320	W70	12" x 10 ³ / ₄ ", 200 ct.	2400/cs.
16201326	W69	12" x 10 ³ / ₄ ", 500 ct.	3000/cs.

D. SOFT-FOLD™ FOIL SANDWICH WRAPS PACTIV

Glue design laminated foil sandwich wraps.

16206540	W65	500 ct., 14" x 16", Plain	1000/cs.
-----------------	-----	---------------------------	----------

E. REYNOLDS® CUSHION-FOLD® SANDWICH WRAP REYNOLDS® FOOD PACKAGING

Service is fast and easy with Reynolds® Cushion-Fold sandwich wraps, the wrap with superior dead fold to conform tightly to every shape. Triple thermal barrier protection (an outer layer of foil; soft, absorbent paper laminate; insulating air pockets between the two layers) keeps hot foods hot and cold foods cold and prevents leaks. Cushion-Fold sandwich wraps give your products the quality image that only comes with foil. Wraps are attractively patterned with specific sandwich identification.

17307524	7524	10 ¹ / ₂ " x 14", Plain	2500/cs.
-----------------	------	---	----------

F. REYNOLDS® FOIL INTERFOLDED SHEETS REYNOLDS® FOOD PACKAGING

Pop up one-at-a-time for fast service. Choose plain, gold or striped foil sheets. Wide selection of sizes to help prevent waste. All interfolded sheets come with dual Universal Product Codes (UPC) and Kosher U on every box. Sheets can be used for wrapping potatoes, sandwiches, biscuits, etc.

17300712	712	9" x 10 ³ / ₄ ", Gold	2400/cs.
17307110	711	9" x 10 ³ / ₄ ", Plain	3000/cs.
17300720	721M	12" x 10 ³ / ₄ ", Metro	3000/cs.
17301720	720	12" x 10 ³ / ₄ ", Plain	2400/cs.
17300721	721	12" x 10 ³ / ₄ ", Plain	3000/cs.

FOIL ROLLS

G. HI-VALU ALUMINUM FOIL ROLL PRIME SOURCE®

Perfect for freezing, storing and cooking in the foodservice industry. Corrugated cutter box for easy tear.

73009121	73009121	12" x 1000', Standard	1/rl.
-----------------	----------	-----------------------	-------

Foil Rolls/Foodservice Film Sheets



A. ALUMINUM FOIL ROLLS PRIME SOURCE®

Perfect for freezing, storing and cooking in the food service industry. Corrugated cutterbox for easy tear.

75001210	75001210	12" x 1000', Lightweight	1/rl.
75001850	75001850	18" x 500', Standard	1/rl.
75002050	75002050	18" x 500', Heavy-Duty	1/rl.
75001810	75001810	18" x 1000', Standard	1/rl.
75002010	75002010	18" x 1000', Heavy-Duty	1/rl.
75002011	75002011	24" x 1000', Heavy-Duty	1/rl.



B. FOIL DISPENSER ROLLS PACTIV

Ideal for facilitating freezing, storage and cooking in all types of foodservice applications.

Classic

16206497	WC12	12" x 1000'	1/ea.
16206498	WC18	18" x 500'	1/rl.
16206499	WC17	18" x 1000'	1/rl.

Standard

16206500	W12	12" x 1000'	1/ea.
16206505	W18	18" x 500'	1/ea.
16206504	W17	18" x 1000'	1/rl.

Heavy-Duty

16206520	W26	12" x 500'	1/rl.
16206525	W28	18" x 500'	1/rl.
16206510	W23	18" x 1000'	1/rl.
16206515	W25	24" x 1000'	1/rl.

Extra Heavy-Duty

16206590	W38	18" x 500'	1/rl.
16202450	W35	24" x 500'	1/rl.



C. REYNOLDS® ALUMINUM FOIL REYNOLDS® FOOD PACKAGING

Economical and practical, wherever its used. Each carton is wrapped in shrink film to help keep cartons cleaner and more sanitary. Set-up instructions and directions for use in Spanish, French and English. Easy dispensing system makes cutting foil a quick and easy operation. Foil retains heat naturally to help reduce energy costs. Large, easy-to-read item numbers and size. All Reynolds® foil products have been certified Kosher U.

Standard

17300107	611	12" x 1000'	1/rl.
17300061	611M	12" x 1000', Metro	1/rl.
17300613	613	15" x 1000'	1/rl.
17306140	614	18" x 500'	1/rl.
17306150	615	18" x 1000'	1/rl.

Heavy-Duty

17306200	620	12" x 500'	1/rl.
17306220	622	15" x 500'	1/rl.
17306240	624	18" x 500'	1/rl.
17306242	624M	18" x 500', Metro	1/rl.
17306250	625	18" x 1000'	1/rl.
17306270	627	24" x 1000'	1/rl.

Extra Heavy-Duty

17300108	632	18" x 500'	1/rl.
----------	-----	------------	-------



FOODSERVICE FILM SHEETS

D. POLY SHEETS PRIME SOURCE®

Food grade LDPE poly sheets.

76000875	76000875	22" x 30", Clear, 1 MIL	500/cs.
----------	----------	-------------------------	---------

E. TRUE TARE SCALE SHEETS PRIME SOURCE®

High density scale sheets.

76008900	76008900	9" x 12", Natural	4000/cs.
----------	----------	-------------------	----------



Foodservice Film Sheets/Foodservice Film Rolls



FOODSERVICE PROCESSING, WRAPS & APPAREL



A. CLEAR PLASTIC SHEETS BAGCRAFT/PAPERCON

Clear polyethylene protection sheets for use as scale sheets, pick-sheets, separators, and liners. Easy release from fresh, frozen or packaged products. Waterproof and greaseproof to retain products appearance and freshness. Can be used in microwave. Convenient interfolded pop-up dispenser boxes. FDA approved. Polyethylene.

16401909	014006	6" x 10 ³ / ₄ "	Clear	10,000/cs.
16400088	014008	8" x 10 ³ / ₄ "	Clear	10,000/cs.
16400015	014010	10" x 10 ³ / ₄ "	Clear	10,000/cs.
16401908	014012	12" x 10 ³ / ₄ "	Clear	10,000/cs.
16401907	014015	15" x 10 ³ / ₄ "	Clear	10,000/cs.



B. SATIN PAC DELI FILM GEORGIA PACIFIC FOODSERVICE

High-density polyethylene interfolded all purpose deli sheets. Provides barrier to contain wetness. Frozen foods separate without thawing.

15004920	S8	8" x 10 ³ / ₄ "	1000 ct., Clear	10,000/cs.
15004910	S10	10" x 10 ³ / ₄ "	1000 ct., Clear	10,000/cs.
15005506	S12	12" x 10 ³ / ₄ "	1000 ct., Clear	10,000/cs.
15000151	S15	15" x 10 ³ / ₄ "	1000 ct., Clear	10,000/cs.



C. HI-VALU ALL PURPOSE CLING FILM PRIME SOURCE®

Small box design is environmentally friendly by saving on corrugate. Increase profits per SKU. Ship and stock more rolls in the same space as before, reducing transportation and carrying costs per unit. Heavy-duty, self-dispensing cutter boxes come with lock top design, improved film exit slot, and hand holes for easy transportation. An extended front flap allows the box to maintain structural integrity. Flap includes a standard, full-length cutting blade with an improved cutting edge. Film roll mounted on roller-core plugs for ease in dispensing and to reduce drag. An all-purpose, tinted foodservice film with excellent cling properties, providing outstanding clarity and protection.

73000010	73000010	12" x 2000'	1/ea.
73000009	73000009	18" x 2000'	1/ea.
73000011	73000011	24" x 2000'	1/ea.



D. HI-VALU FOODSERVICE FILM PRIME SOURCE®

Film in cutter box.

73008001	73008001	12" x 2000'	Clear	12/cs.
73008000	73008000	18" x 2000'	Clear	1/rl.



E. CLING FILM PRIME SOURCE®

All purpose cling film in easy-to-use, self-dispensing cutter box. Safe cutting edge that cuts cleanly and effortlessly.

75003820	75003820	12" x 1000'	1/ea.
75003821	75003821	12" x 2000'	1/ea.
75003822	75003822	12" x 3000'	1/ea.
75003835	75003835	15" x 2000'	1/ea.
75003830	75003830	18" x 1000'	1/ea.
75003831	75003831	18" x 2000'	1/ea.
75003832	75003832	18" x 3000'	1/ea.
75003838	75003838	24" x 2000'	1/ea.



F. MEAT FILM PRIME SOURCE®

Super-stretch, breathable foodservice film. Excellent heat-seal properties. Outstanding clarity and sparkle. Consistent quality from roll to roll. Clear.

75003811	75003811	12" x 5000'	60 GA	1/rl.
76003840	76003840	12" x 5000'	Economy	1/rl.
75003823	75003823	13" x 5000'	60 GA	1/rl.
75003812	75003812	14" x 5000'	60 GA	1/rl.
75003886	75003886	14" x 5000'	Economy, Spanish/English	1/rl.
76003841	76003841	14" x 5000'	Economy, Import	1/rl.
75003851	75003851	15" x 4000'	60 GA	1/ea.
75003813	75003813	15" x 5000'	60 GA	1/rl.

Foodservice Film Rolls



A. MEAT FILM (CONT.)		PRIME SOURCE®	
75003887	75003887	15" x 5000', Economy, Spanish/English	1/rl.
76003842	76003842	15" x 5000', Economy, Import	1/rl.
75003817	75003817	16" x 5000', 60 GA	1/rl.
76003843	76003843	17" x 5000', Economy	1/rl.
75003814	75003814	17" x 5000', 60 GA	1/rl.
75003815	75003815	18" x 5000', 60 GA	1/rl.
75003888	75003888	18" x 5000', Economy	1/rl.
75003852	75003852	19" x 4000', 60 GA	1/ea.
75003816	75003816	19" x 5000', 60 GA	1/rl.
75003818	75003818	20" x 5000', 60 GA	1/rl.
75003824	75003824	21" x 5000', 60 GA	1/rl.
75003819	75003819	23" x 5000', 60 GA	1/rl.



B. MEAT FILM		PRIME SOURCE®	
Hand wrap meat film roll.			
75003897	75003897	12" x 5000', Clear	1/rl.
75003898	75003898	14" x 5000', Clear	1/rl.
75003899	75003899	15" x 5000', Clear	1/rl.
75003900	75003900	18" x 5000', Clear	1/rl.

C. PREMIUM DUAL-LAYER FILM **PRIME SOURCE®**
 Environmentally conscious multi purpose meat, deli and produce films for packer processing and in-store wrapping. Twice the proven fresh food protective benefits of PVC food film. Increased strength, stretch, puncture resistance and smart memory for package handling. Increased productivity - with extended roll lengths for fewer changeovers and trimmed roll edges for smooth runs down to the core. Economical material costs. Innovative dual-layer film that uses less material than conventional single-layer films. More renewable materials and energy efficient production than other plastics.

75003893	75003893	15" x 5000', Clear	1/rl.
75003894	75003894	17" x 5000', Clear	1/rl.
75003895	75003895	18" x 5000', Clear	1/rl.
75003896	75003896	19" x 5000', Clear	1/rl.



D. PRODUCE FILM **PRIME SOURCE®**
 Super-stretch, breathable foodservice film. Excellent heat-seal properties. Outstanding clarity and sparkle. Consistent quality from roll to roll.

75003845	75003845	14" x 5000', Clear, 58 GA	1/rl.
75003842	75003842	15" x 5000', Clear, 58 GA	1/rl.
75003841	75003841	16" x 5000', Clear, 58 GA	1/rl.
75003843	75003843	17" x 5000', Clear, 58 GA	1/rl.
75003856	75003856	17" x 5000', Green, 60 GA	1/rl.
75003846	75003846	18" x 5000', Clear, 58 GA	1/rl.



E. ANCHOR WRAP FOOD FILM **ANCHOR PACKAGING**
 Premium grade foodservice film with excellent cling and puncture properties. A blue tinted film, with outstanding clarity for food service professionals. All of our cutter boxes come with lock top design, improved film exit slot, and hand holes for easy transportation. A plastic safety blade is included in each box which clips to the front panel while keeping the lid closed. The blade is enclosed in a plastic trolley which cuts in both directions. Anchor Packaging has added a Dri-Gard™ grease and water box protectant to our premium film lines. Dri-Gard™ is a revolutionary box coating that will give added resistance to moisture, grease, and spills that are commonplace in the kitchen. Dri-Gard™ will not only preserve the box integrity but also keep it more sanitary since it can be wiped clean with a damp cloth.

108000311	7318518	18" x 2000', PVC Cling	1/rl.
-----------	---------	------------------------	-------



F. CRYSTAL WRAP FOODSERVICE FILM **ANCHOR PACKAGING**
 Heavy-duty foodservice film with excellent cling and puncture properties. A blue tinted film, with outstanding clarity for food service professionals. All of our cutter boxes come with lock top design, improved film exit slot, and hand holes for easy transportation. Our improved cutting edge and extended front flap allow the box to maintain structural integrity.

10801835	7301835	18" x 2000'	1/rl.
10802450	7302435	24" x 2000'	1/rl.



Film Rolls/Liners/Foam Meat Trays & Pads



A. E15 PERFORATED CLING FILM ANCHOR PACKAGING

Temporary overwrap of all food items. Pre-measured, perforated sheets for the exact size every time with less waste. Dispenser box keeps film sanitary and eliminates the need for tier dispensers. Sticks well to china, glass, plastic and stainless steel.

10801565	E1565	6" x 5", 3000 ct.	1/r.
10800026	E151010	10" x 10", 1900 ct.	1/r.
10800025	E151212	12" x 12", 1600 ct.	1/r.
10801414	E151414	14" x 14", 1200 ct.	1/r.
10809501	E151515	15" x 15", 1100 ct.	1/r.



B. PURITY WRAP™ ALL PURPOSE FOOD FILM ANCHOR PACKAGING

Premium grade foodservice film with excellent cling and puncture properties. A blue tinted film with outstanding clarity for food service professionals. All of our cutter boxes come with lock top design, improved film exit slot, and hand holes for easy transportation. Our improved cutting edge and extended front flap allow the box to maintain structural integrity. Anchor Packaging has added a Dri-Gard™ grease and water box protectant to our premium film lines. Dri-Gard™ is a revolutionary box coating that will give added resistance to moisture, grease, and spills that are commonplace in the kitchen. Dri-Gard™ preserves box integrity. With Dri-Gard™, box can be wiped clean with a damp cloth.

10801220	7309422	12" x 2000'	1/r.
10801820	7309482	18" x 2000'	1/r.
10802420	7309442	24" x 2000'	1/r.



C. THE MILER® INSTITUTIONAL CLING FILM ANCHOR PACKAGING

All purpose cling film. Used in conjunction with Anchor Miler dispenser for restaurants and institutions.

10801200	MF12	12" x 5280'	1/r.
10801800	MF18	18" x 5280'	1/r.



D. REYNOLDS® FOODSERVICE FILM REYNOLDS® FOOD PACKAGING

Anti-fog with excellent clarity, brilliance and cling in the best dispenser. Built-in locking tabs hold cutter blade and lid firmly in place. High impact inserts help protect film and allows for easier turning.

17309200	920	6" x 5", 3000 ct., Clear	1/r.
17309300	930	12" x 12", 1600 ct., Clear	1/r.
17309370	937	14" x 14", 1200 ct., Clear	1/r.
17309000	900	12" x 1000', Clear	1/r.
17309100	910	12" x 2000', Clear	1/r.
17300904	904	18" x 1000', Clear	1/r.
17309140	914	18" x 2000', Clear	1/r.
17309150	915	18" x 3000', Clear	1/r.
17309160	916	24" x 2000', Clear	1/r.



E. REYNOLDS® FOODSERVICE FILM SLIDE CUTTER REYNOLDS® FOOD PACKAGING

Slide cutter for use with film rolls.

17300404	SC18	18"	24/cs.
----------	------	-----	--------



CASE/BOX LINERS

F. CELLU LINER™ MEAT/DAIRY CASE LINER SEALED AIR

These four-ply case liners are the most effective way to reduce odor and bacteria and enhance appearance in meat, poultry and dairy cases.

18000154	100069636	30" x 250', White	1/r.
----------	-----------	-------------------	------

FOAM MEAT TRAYS & PADS



G. FAMILY PACK SERIES FOAM TRAYS PACTIV

Supermarket foam trays.

16201170	HTF91014	10" x 14", Black, 10" x 14" x 1"	100/cs.
16201407	HTF11014	10" x 14", White, 10" x 14" x 1"	100/cs.

Foam Meat Trays & Pads



A. FOAM MEAT TRAYS

PACTIV

Supermarket trays provide the right display for your products.

Black

16207050	TFB01S0	5 ¹³ / ₆₄ " x 5 ¹³ / ₆₄ " x 39/64", 1S, S Series	1000/cs.
16200540	TFB02S0	8 ¹³ / ₆₄ " x 5 ¹³ / ₆₄ " x 39/64", 2S, S Series	500/cs.
16200427	TFB0020	8 ¹³ / ₆₄ " x 5 ¹³ / ₆₄ " x 45/64", 2, Deep Series	500/cs.
16200487	TFB04S0	9 ¹ / ₈ " x 7 ¹ / ₈ " x 39/64", 4S, S Series	500/cs.
16200623	TFB04D1	9 ¹ / ₂ " x 7" x 1 ¹ / ₄ ", 4D, Deep Series	500/cs.
16200670	TFB10S0	10 ³ / ₄ " x 5 ³ / ₄ " x 39/64", 10S, S Series	500/cs.
16200844	TFB009H	11 ²⁹ / ₃₂ " x 9 ²⁹ / ₃₂ " x 1 ¹³ / ₆₄ ", 9H, Family Pack Series	250/cs.

Blue

16200663	TF40020	8 ¹³ / ₆₄ " x 5 ¹³ / ₆₄ " x 45/64", 2, Deep Series	500/cs.
16201195	TF410S0	10 ³ / ₄ " x 5 ³ / ₄ " x 39/64", 10S, S Series	500/cs.

Green

16200696	TP20020	8 ¹³ / ₆₄ " x 5 ¹³ / ₆₄ " x 45/64", 2	500/cs.
----------	---------	---	---------

Rose

16201409	TF902S0	8 ¹³ / ₆₄ " x 5 ⁴⁵ / ₆₄ " x 39/64", 2S, S Series	500/cs.
16200428	TF90020	8 ¹³ / ₆₄ " x 5 ¹³ / ₆₄ " x 45/64", 2, Deep Series	500/cs.
16200483	TF904S0	9 ¹ / ₈ " x 7 ¹ / ₈ " x 39/64", 4S, S Series	500/cs.
16200470	TF904D1	9 ¹ / ₂ " x 7" x 1 ¹ / ₄ ", 4D, Deep Series	500/cs.
16200042	TF910S0	10 ³ / ₄ " x 5 ³ / ₄ " x 39/64", 10S, S Series	500/cs.
16201208	TF916S0	11 ⁴⁵ / ₆₄ " x 7 ⁵ / ₁₆ " x 39/64", 16S, S Series	250/cs.
16200669	TF912S0	11 ¹ / ₄ " x 9 ¹ / ₄ " x 6/10", 12S, S Series	250/cs.
16201573	TF925SH	14 ²⁹ / ₃₂ " x 8" x 1", 25SH, Family Pack Series	250/cs.

White

16209001	TF101S0	5 ¹³ / ₆₄ " x 5 ¹³ / ₆₄ " x 39/64", 1S, S Series	1000/cs.
16200401	TF1002P	8" x 5 ³ / ₄ " x 1 ² / ₅ ", 2P, Deep Series	400/cs.
16203734	TF10015	8 ³ / ₈ " x 3 ⁷ / ₈ " x 7/8", 1 ¹ / ₂ , Deep Series	1000/cs.
16200688	TF117S0	8 ¹ / ₂ " x 4 ⁵ / ₈ " x 5/8", 17S, S Series	1000/cs.
16200548	TF10020	8 ¹³ / ₆₄ " x 5 ¹³ / ₆₄ " x 45/64", 2, Deep Series	500/cs.
16200681	TF102S0	8 ¹³ / ₆₄ " x 5 ⁴⁵ / ₆₄ " x 39/64", 2S, S Series	500/cs.
16201222	TF120S0	8 ⁴⁵ / ₆₄ " x 6 ¹³ / ₆₄ " x 39/64", 20S, S Series	500/cs.
16200682	TF104D1	9 ¹ / ₂ " x 7" x 1 ¹ / ₄ ", 4D, Deep Series	500/cs.
16200683	TF104S0	9 ¹ / ₈ " x 7 ¹ / ₈ " x 39/64", 4S, S Series	500/cs.
16200685	TF110S0	10 ³ / ₄ " x 5 ³ / ₄ " x 39/64", 10S, S Series	500/cs.
16200684	TF108S0	10 ¹ / ₂ " x 8 ¹ / ₄ " x 1 ¹ / ₅ ", 8S, S Series	500/cs.
16200687	TF116S0	11 ⁴⁵ / ₆₄ " x 7 ⁵ / ₁₆ " x 39/64", 16S, S Series	250/cs.
16200259	TF112S0	11 ¹ / ₄ " x 9 ¹ / ₄ " x 6/10", 12S, S Series	2/125/cs.
16200091	TF11216	12 ¹ / ₂ " x 16 ¹ / ₈ " x 3/4", 1216, Family Pack Series	100/cs.

Yellow

16201090	TF3002P	8" x 5 ³ / ₄ " x 1 ² / ₅ ", 2P, Deep Series	400/cs.
16200424	TF30020	8 ¹³ / ₆₄ " x 5 ¹³ / ₆₄ " x 45/64", 2, Deep Series	500/cs.
16201287	TF3004H	9 ¹ / ₄ " x 7 ¹ / ₄ " x 1 ¹ / ₄ ", 4H, Family Pack Series	400/cs.
16200466	TF304D1	9 ¹ / ₂ " x 7" x 1 ¹ / ₄ ", 4D, Deep Series	500/cs.
16201194	TF310S0	10 ³ / ₄ " x 5 ³ / ₄ " x 39/64", 10S, S Series	500/cs.
16200437	TF3008H	10 ³⁹ / ₆₄ " x 8 ⁵ / ₁₆ " x 1 ¹³ / ₆₄ ", 8H, Family Pack Series	400/cs.
16201231	TF325SH	14 ²⁹ / ₃₂ " x 8" x 1", 25SH, Family Pack Series	250/cs.

B. FOAM TRAYS

PACTIV

Disposable foam food trays.

16200680	51Y101P	5 ¹ / ₄ " x 5 ¹ / ₄ " x 1", 1, White	1000/cs.
16200807	TF902P	8" x 5 ³ / ₄ " x 1 ² / ₅ ", 2P, Black	400/cs.
16200569	51P917S	8 ¹ / ₂ " x 4 ⁵ / ₈ " x 5/8", 17S, Black	1000/cs.
16200926	TF908PH	10 ¹ / ₂ " x 8 ¹ / ₄ " x 1 ¹ / ₅ ", 8PH, Black	400/cs.

C. CRYOVAC® FOAM TRAY

SEALED AIR

Cryovac® foam trays provide superior strength, durability, and variety. We deliver consistent quality in weight, color, count, and machinability.

18001218	TS4PY	4P, Yellow, 9 ¹ / ₄ " x 6 ³ / ₄ " x 1 ⁵ / ₁₆ "	500/cs.
----------	-------	--	---------





Meat Tray Pads/Pallet Wrap/Twine

FOODSERVICE PROCESSING, WRAPS & APPAREL



A. DRI-LOC® ABSORBENT PADS SEALED AIR

One-way valves and sealed edges keep product fresher, longer. Reduces costly rewraps and product downgrades. Keeps display cases cleaner. Greater customer satisfaction; packages stay drier and more attractive. Pads absorb juices only from the bottom of the pad and do not dry out the meat. Meat retains fresh, juicy appearance longer.

White/White

18005950	AC25WW	3 1/8" x 6", 25 - 30 g Absorbency	2000/cs.
18000110	65816	4" x 7", 40 - 45 g Absorbency	2000/cs.
18000111	AC40WW	4" x 7", 40 - 45 g Absorbency	2000/cs.
18000124	AC50WW	4 3/4" x 7", 50 - 55 g Absorbency	2000/cs.

Black/White

18000050	AC40BKW	4" x 7", 40 - 45 g Absorbency	2000/cs.
18005964	AC50BKW	4 3/4" x 7", 50 - 55 g Absorbency	2000/cs.

PALLET WRAP



B. PALLET WRAP PRIME SOURCE®

Wrap has excellent puncture resistance and superior holding force. Remarkable stretch and cling characteristics allow for a fast, smooth application. Available in various widths.

75002711	75002711	12" x 1500', 80 GA	4/cs.
75002726	75002726	12" x 1500', 18 MIC	4/cs.
75002725	75002725	12" x 2000', 14 MIC	4/cs.
75002705	75002705	15" x 1500', 70 GA	4/cs.
75002712	75002712	15" x 1500', 80 GA	4/cs.
75002728	75002728	15" x 1500', 18 MIC	4/cs.
75002727	75002727	15" x 2000', 14 MIC	4/cs.
75002710	75002710	16" x 1500', 65 GA	4/cs.
75002706	75002706	18" x 1500', 70 GA	4/cs.
75002713	75002713	18" x 1500', 80 GA	4/cs.
75002729	75002729	18" x 1500', 16 MIC	4/cs.
75002730	75002730	18" x 1500', 18 MIC	4/cs.
75002722	75002722	18" x 1500', 19 MIC	4/cs.



C. PALLET WRAP PRIME SOURCE®

Wrap has excellent puncture resistance and superior holding force. Remarkable stretch and cling characteristics allow for a fast, smooth application. Available in various widths.

75002735	75002735	20" x 5000', 19 MIC	1/ea.
75002736	75002736	20" x 6000', 18 MIC	1/ea.
75002737	75002737	20" x 6000', 19 MIC	1/ea.

TWINE



D. BUTCHER'S TWINE PRIME SOURCE®

Cotton/polyester blend.

75000202	75000202	12-Ply, 1/2 lb. Ball	96/cs.
75000201	75000201	12-Ply, 1/2 lb. Ball	1/ea.
750002001	75000200	12-Ply, 2 lb. Cone	1/ea.
750002031	75000203	16-Ply, 2 lb. Cone	1/ea.
75000203	75000203	16-Ply, 2 lb. Cone	25/cs.
750002041	75000204	16-Ply, 5 lb. Cone	1/ea.
750002061	75000206	20-Ply, 2 lb. Cone	1/ea.
75000206	75000206	20-Ply, 2 lb. Cone	25/cs.
75000208	75000208	24-Ply, 8 oz. Ball	96/cs.
750002091	75000209	24-Ply, 2 lb. Cone	1/ea.
75000209	75000209	24-Ply, 2 lb. Cone	25/cs.
750002211	75000221	#60, 1 lb. Ball	1/ea.



E. TWINE PRIME SOURCE®

Rayon twine.

750002251	75000225	2 lb. Cone	1/ea.
-----------	----------	------------	-------

Vinyl/Poly Gloves



VINYL/POLY GLOVES

A. HANDSOFF® POLYETHYLENE DISPOSABLE GLOVES

PRIME SOURCE®

Economical, single-use poly gloves with a lightly embossed surface. Easy to slip on and off. Fit either hand. Packaged in a dispenser box. Clear.

75007110	75007110	X-Small, 100/Box	10,000/cs.
75007125	75007125	Small, 500/Box	10,000/cs.
75007120	75007120	Small, 100/Box	10,000/cs.
75007122	75007122	Small, 500/Box	2000/cs.
75007123	75007123	Small, 500/Box	10,000/cs.
75007135	75007135	Medium, 500/Box	10,000/cs.
750071305	75007130	Medium, Embossed, 100/Box	1000/cs.
75007130	75007130	Medium, Embossed, 100/Box	10,000/cs.
750071395	75007139	Medium, Economy, 100/Box	1000/cs.
75007139	75007139	Medium, Economy, 100/Box	10,000/cs.
75007132	75007132	Medium, 500/Box	2000/cs.
75007133	75007133	Medium, 500/Box	10,000/cs.
75007145	75007145	Large, 500/Box	10,000/cs.
750071495	75007149	Large, 100/Box	1000/cs.
75007149	75007149	Large, 100/Box	10,000/cs.
750071405	75007140	Large, 100/Box	1000/cs.
75007140	75007140	Large, 100/Box	10,000/cs.
75007147	75007147	Large, 100/Header	10,000/cs.
75007142	75007142	Large, 500/Box	2000/cs.
75007143	75007143	Large, 500/Box	10,000/cs.
750071595	75007159	X-Large, 100/Box	1000/cs.
75007159	75007159	X-Large, 100/Box	10,000/cs.
75007157	75007157	X-Large, 100/Header	10,000/cs.
750071505	75007150	X-Large, 100/Box	1000/cs.
75007150	75007150	X-Large, 100/Box	10,000/cs.
75007152	75007152	X-Large, 500/Box	2000/cs.
75007153	75007153	X-Large, 500/Box	10,000/cs.

Premium Grade

75007126	75007126	Small, 1 MIL, 100/Box	1000/cs.
75007136	75007136	Medium, 1 MIL, 100/Box	1000/cs.
75007146	75007146	Large, 1 MIL, 100/Box	1000/cs.
75007156	75007156	X-Large, 1 MIL, 100/Box	1000/cs.

B. HI-VALU POLYETHYLENE GLOVES

PRIME SOURCE®

Economical, single-use poly gloves with a lightly embossed surface. Easy to slip on and off. Fit either hand. Packaged in a dispenser box.

73007122	73007122	Small, 500/Box	2000/cs.
73007132	73007132	Medium, 500/Box	2000/cs.
73007142	73007142	Large, 500/Box	2000/cs.
73007152	73007152	X-Large, 500/Box	2000/cs.





Vinyl/Poly Gloves

FOODSERVICE PROCESSING, WRAPS & APPAREL



A. HANDSOFF® VINYL DISPOSABLE GLOVES PRIME SOURCE®

High quality single-use vinyl gloves. Increased sensitivity and stretch-to-fit.

Lightly Powdered

75006111	75006111	X-Small, 5 MIL	400/cs.
75006110	75006110	X-Small, 5 MIL	1000/cs.
75006121	75006121	Small, 5 MIL	400/cs.
75006120	75006120	Small, 5 MIL	1000/cs.
75006621	75006621	Small, Blue, 5 MIL	400/cs.
75006620	75006620	Small, Blue, 5 MIL	1000/cs.
75006131	75006131	Medium, 5 MIL	400/cs.
75006130	75006130	Medium, 5 MIL	1000/cs.
75006631	75006631	Medium, Blue, 5 MIL	400/cs.
75006630	75006630	Medium, Blue, 5 MIL	1000/cs.
75006141	75006141	Large, 5 MIL	400/cs.
75006140	75006140	Large, 5 MIL	1000/cs.
75006641	75006641	Large, Blue, 5 MIL	400/cs.
75006640	75006640	Large, Blue, 5 MIL	1000/cs.
75006151	75006151	X-Large, 5 MIL	400/cs.
75006150	75006150	X-Large, 5 MIL	1000/cs.
75006651	75006651	X-Large, Blue, 5 MIL	400/cs.
75006650	75006650	X-Large, Blue, 5 MIL	1000/cs.
75006155	75006155	2X-Large, 5 MIL	1000/cs.

Powder-Free

75006210	75006210	X-Small, 5 MIL	1000/cs.
75006220	75006220	Small, 5 MIL	1000/cs.
75006720	75006720	Small, Blue, 5 MIL	1000/cs.
750062305	75006230	Medium, 5 MIL	100/bx.
75006231	75006231	Medium, 5 MIL	400/cs.
75006230	75006230	Medium, 5 MIL	1000/cs.
75006730	75006730	Medium, Blue, 5 MIL	1000/cs.
75006241	75006241	Large, 5 MIL	400/cs.
75006240	75006240	Large, 5 MIL	1000/cs.
75006740	75006740	Large, Blue, 5 MIL	1000/cs.
75006251	75006251	X-Large, 5 MIL	400/cs.
75006250	75006250	X-Large, 5 MIL	1000/cs.
75006750	75006750	X-Large, Blue, 5 MIL	1000/cs.
75006255	75006255	2X-Large, 5 MIL	1000/cs.



B. HANDSOFF® VINYL GENERAL PURPOSE GLOVES PRIME SOURCE®

General purpose, single-use vinyl gloves. 10"L with rolled cuff.

Lightly Powdered

75006160	75006160	Small, 3 MIL	1000/cs.
75006170	75006170	Medium, 3 MIL	1000/cs.
75006180	75006180	Large, 3 MIL	1000/cs.
75006190	75006190	X-Large, 3 MIL	1000/cs.

Powder-Free

75006260	75006260	Small, 3 MIL	1000/cs.
75006270	75006270	Medium, 3 MIL	1000/cs.
75006281	75006281	Large, 3 MIL	400/cs.
75006280	75006280	Large, 3 MIL	1000/cs.
75006290	75006290	X-Large, 3 MIL	1000/cs.

Latex, Nitrile & Reusable Gloves



LATEX GLOVES

A. HI-VALU LATEX GLOVES PRIME SOURCE®

High quality, single-use latex gloves. Fit either hand. Packaged in a dispenser box.

Powdered

73005160	73005160	Small, 3 MIL	1000/cs.
73005170	73005170	Medium, 3 MIL	1000/cs.
73005180	73005180	Large, 3 MIL	1000/cs.
73005190	73005190	X-Large, 3 MIL	1000/cs.

Powder-Free

73005260	73005260	Small, 3 MIL	1000/cs.
73005270	73005270	Medium, 3 MIL	1000/cs.
73005280	73005280	Large, 3 MIL	1000/cs.
73005290	73005290	X-Large, 3 MIL	1000/cs.



NITRILE GLOVES

B. HANDSOFF® NITRILE DISPOSABLE GLOVES PRIME SOURCE®

High quality, single-use gloves. Protection against animal fats, oil-based solvents, petroleum, caustics and acids. 9 1/2" length with rolled cuff. Gloves fit either hand. Blue.

Lightly Powdered

75008310	75008310	X-Small, 5 MIL	1000/cs.
75008320	75008320	Small, 5 MIL	1000/cs.
75008330	75008330	Medium, 5 MIL	1000/cs.
75008340	75008340	Large, 5 MIL	1000/cs.
75008350	75008350	X-Large, 5 MIL	1000/cs.

Powder-Free

75008410	75008410	X-Small, 5 MIL	1000/cs.
75008420	75008420	Small, 5 MIL	1000/cs.
75008430	75008430	Medium, 5 MIL	1000/cs.
75008440	75008440	Large, 5 MIL	1000/cs.
75008450	75008450	X-Large, 5 MIL	1000/cs.



REUSABLE GLOVES

C. HANDSOFF® REUSABLE FLOCK-LINED LATEX GLOVES PRIME SOURCE®

Embossed 13" gauntlet with straight cuff. Soft cotton flock lining absorbs perspiration and comforts the hand. Not for medical use.

75005822	75005822	Small, Blue, 20 MIL	144/cs.
75005722	75005722	Small, Yellow, 20 MIL	144/cs.
75005832	75005832	Medium, Blue, 20 MIL	144/cs.
75005732	75005732	Medium, Yellow, 20 MIL	144/cs.
75005842	75005842	Large, Blue, 20 MIL	144/cs.
750057425	75005742	Large, Yellow, 20 MIL	12/cs.
75005742	75005742	Large, Yellow, 20 MIL	144/cs.
75005752	75005752	X-Large, Yellow, 20 MIL	144/cs.
75005852	75005852	X-Large, Blue, 20 MIL	144/cs.

General Purpose

75005710	75005710	X-Small, Yellow	144/cs.
750057205	75005720	Small, Yellow	12/cs.
75005720	75005720	Small, Yellow	144/cs.
750057305	75005730	Medium, Yellow	12/cs.
75005730	75005730	Medium, Yellow	144/cs.
750057405	75005740	Large, Yellow	12/cs.
75005740	75005740	Large, Yellow	144/cs.
750057505	75005750	X-Large, Yellow	12/cs.
75005750	75005750	X-Large, Yellow	144/cs.





Bouffant Caps/Hairnets/Beard Guards

FOODSERVICE PROCESSING, WRAPS & APPAREL

BOUFFANT CAPS/HAIRNETS



A. PRIME SOURCE® BOUFFANT CAPS

PRIME SOURCE®

Latex-free caps that are comfortable and cool to wear.

Blue			
75009242	75009242	18"	1000/cs.
75009244	75009244	21"	1000/cs.
75009246	75009246	24"	1000/cs.
Green			
75009232	75009232	18"	1000/cs.
75009234	75009234	21"	1000/cs.
75009236	75009236	24"	1000/cs.
White			
75009222	75009222	18"	1000/cs.
75009225	75009224	21"	100/cs.
75009224	75009224	21"	1000/cs.
750092265	75009226	24"	100/cs.
75009226	75009226	24"	1000/cs.
75009228	75009228	28"	1000/cs.
White/Pleated			
75009252	75009252	18"	1000/cs.
75009254	75009254	21"	1000/cs.
75009256	75009256	24"	1000/cs.

B. PRIME SOURCE® HAIRNETS

PRIME SOURCE®

Easy to wear elastic fit. Regular size 1/8" honeycomb weave. 100 per pack.

75009202	75009202	18", White	1000/cs.
75009214	75009214	21", Brown	1000/cs.
75009204	75009204	21", White	1000/cs.
75009206	75009206	24", White	1000/cs.

BEARD GUARDS

C. PRIME SOURCE® BEARD GUARDS

PRIME SOURCE®

Full size and easy to wear. Elastic band keeps guard securely in place. Cloth-like, non-woven, lint free fabric and breathable fine mesh nylon. 100 per pack.

Nylon Mesh			
75009267	75009267	18", Blue	1000/cs.
75009266	75009266	18", White	1000/cs.
Polypropylene			
750092625	75009262	18", White	100/cs.
75009262	75009262	18", White	1000/cs.
75009264	75009264	21", White	500/cs.

D. PRIME SOURCE® POLY HOOD

PRIME SOURCE®

A bouffant and beard guard all in one.

75009346	75009346	17", White	1000/cs.
----------	----------	------------	----------

Disposable Aprons/Smocks



DISPOSABLE APRONS/SMOCKS

A. PRIME SOURCE® POLYETHYLENE APRONS PRIME SOURCE®

Economical light-duty alternative.

Smooth Finish

75007249	75007249	24"W x 42"L, White, Bulk Pack, 1 MIL	1000/cs.
750072505	75007250	24"W x 42"L, White, Indiv. Pack, 1 MIL	100/cs.
75007250	75007250	24"W x 42"L, White, Indiv. Pack, 1 MIL	1000/cs.
75007270	75007270	28"W x 46"L, Blue, Bulk Pack, 1 MIL	500/cs.
75007242	75007242	28"W x 46"L, Blue, Bulk Pack, 1 MIL	1000/cs.
75007271	75007271	28"W x 46"L, Red, Bulk Pack, 1.5 MIL	500/cs.
750072435	75007243	28"W x 46"L, White, Bulk Pack, 1 MIL	100/cs.
75007243	75007243	28"W x 46"L, White, Bulk Pack, 1 MIL	1000/cs.
75007269	75007269	28"W x 46"L, White, Bulk Pack, 1.5 MIL	500/cs.
750072735	75007273	28"W x 46"L, White, Bulk Pack, 2 MIL	100/cs.
75007273	75007273	28"W x 46"L, White, Bulk Pack, 2 MIL	500/cs.
750072445	75007244	28"W x 46"L, White, Indiv. Pack, 1 MIL	100/cs.
75007244	75007244	28"W x 46"L, White, Indiv. Pack, 1 MIL	1000/cs.
750072685	75007268	28"W x 46"L, White, Indiv. Pack, 1.5 MIL	100/cs.
75007268	75007268	28"W x 46"L, White, Indiv. Pack, 1.5 MIL	500/cs.
75007248	75007248	28"W x 55"L, White, Bulk Pack, 1.5 MIL	500/cs.

Embossed Finish

75000089	75000089	28"W x 46"L, Blue, Bulk Pack, 1.5 MIL	500/cs.
75007275	75007275	28"W x 46"L, Blue, Bulk Pack, 1.5 MIL	500/cs.
75007239	75007239	28"W x 46"L, Clear, Bulk Pack, 1 MIL	1000/cs.
75007274	75007274	28"W x 46"L, Clear, Bulk Pack, 2 MIL	500/cs.
75007240	75007240	28"W x 46"L, Clear, Indiv. Pack, 1 MIL	1000/cs.
75007241	75007241	28"W x 46"L, Clear, Roll, 1 MIL	1000/cs.
75007246	75007246	28"W x 46"L, White, Bulk Pack, 1 MIL	1000/cs.
75007267	75007267	28"W x 46"L, White, Bulk Pack, 1.5 MIL	500/cs.
750072725	75007272	28"W x 46"L, White, Bulk Pack, 2 MIL	100/cs.
75007272	75007272	28"W x 46"L, White, Bulk Pack, 2 MIL	500/cs.
75007247	75007247	28"W x 46"L, White, Indiv. Pack, 1 MIL	1000/cs.
750072665	75007266	28"W x 46"L, White, Indiv. Pack, 1.5 MIL	100/cs.
75007266	75007266	28"W x 46"L, White, Indiv. Pack, 1.5 MIL	500/cs.
75007253	75007253	28"W x 56"L, White, Bulk Pack, 1 MIL	500/cs.
75007245	75007245	32"W x 52"L, White, 1.4 MIL	500/cs.
75007259	75007259	35"W x 60"L, White, Bulk Pack, 1.5 MIL	500/cs.



B. PRIME SOURCE® VINYL APRONS PRIME SOURCE®

Extra protection from grease, oil and fat. Made of quality vinyl with nylon-serged edges and heat-sealed grommets.

Raw Edge

75007037	75007037	28" x 46", Blue, 1 MIL	1000/cs.
75007284	75007284	30" x 36", White, 8 MIL	72/cs.
750070015	75007001	35" x 45", Blue, 6 MIL	12/cs.
75007001	75007001	35" x 45", Blue, 6 MIL	72/cs.
76007001	76007001	35" x 45", Blue, 6 MIL	2500/cs.
750070285	75007028	35" x 45", White, 8 MIL	12/pk.
75007002	75007002	35" x 48", Blue, 6 MIL	72/cs.
76007002	76007002	35" x 48", Blue, 6 MIL	2500/cs.
75007003	75007003	35" x 50", Blue, 6 MIL	72/cs.
75007004	75007004	35" x 55", Blue, 6 MIL	72/cs.

Sewn Edge

75007006	75007006	35" x 45", Blue, 6 MIL	72/cs.
75007026	75007026	35" x 45", Blue, 8 MIL	72/cs.
75007007	75007007	35" x 48", Blue, 6 MIL	72/cs.
75007027	75007027	35" x 48", Blue, 8 MIL	72/cs.
75007035	75007035	35" x 48", White, 6 MIL	72/cs.
75007008	75007008	35" x 50", Blue, 6 MIL	72/cs.
75007009	75007009	35" x 55", Blue, 6 MIL	72/cs.
75007029	75007029	35" x 55", Blue, 8 MIL	72/cs.

Die-Cut

75007036	75007036	35" x 52", White, 8 MIL	72/cs.
----------	----------	-------------------------	--------



Disposable Aprons/Smocks/Sleeves



FOODSERVICE PROCESSING, WRAPS & APPAREL



A. PRIME SOURCE® APRON GOWNS			PRIME SOURCE®
Embossed gown with elastic wrist. Individually wrapped. 4 MIL thickness.			
75007279	75007279	X-Large, Blue	100/cs.
75007280	75007280	X-Large, Blue, Bulk	100/cs.
75007281	75007281	X-Large, White	100/cs.

B. PRIME SOURCE® DISPOSABLE SMOCKS			PRIME SOURCE®
Will not absorb moisture. Extremely durable and tear resistant. Reinforced neck band. Full-length elastic cuffed sleeves. Polyethylene coated. Standard length. White.			
75009270	75009270	Small	100/cs.
75009271	75009271	Medium	100/cs.
75009272	75009272	Large	100/cs.
75009273	75009273	X-Large	100/cs.
75009278	75009278	X-Large, Short Sleeve	100/cs.
75009274	75009274	2X-Large	100/cs.
75009279	75009279	2X-Large, Short Sleeve	100/cs.
75009275	75009275	3X-Large	100/cs.
75009276	75009276	4X-Large	100/cs.
75009277	75009277	5X-Large	100/cs.



C. PRIME SOURCE® DISPOSABLE SMOCKS			PRIME SOURCE®
Extra long smocks will not absorb moisture. Extremely durable and tear resistant. Reinforced neck band. Full-length elastic cuffed sleeves. White.			
75009280	75009280	Small	100/cs.
75009281	75009281	Medium	100/cs.
75009282	75009282	Large	100/cs.
75009283	75009283	X-Large	100/cs.
75009284	75009284	2X-Large	100/cs.
75009285	75009285	3X-Large	100/cs.

DISPOSABLE SLEEVES



D. PRIME SOURCE® POLYETHYLENE SLEEVES			PRIME SOURCE®
Low cost waterproof protection for light-duty, limited-use applications. Heat-sealed with enclosed elastic at each end.			
75007231	75007231	16", Blue	2000/cs.
75007221	75007221	16", White	2000/cs.
75007224	75007224	18", Blue	2000/cs.
75007223	75007223	18", White	2000/cs.



E. PRIME SOURCE® VINYL SLEEVES			PRIME SOURCE®
Heat-sealed with enclosed elastic at the wrist and shoulder.			
75007071	75007071	18", Blue, 6 MIL	144/cs.
75007081	75007081	18", Blue, 8 MIL	144/cs.
75007064	75007064	18", Clear, 4 MIL	144/cs.
75007084	75007084	18", Clear, 8 MIL	144/cs.
75007082	75007082	18", White, 8 MIL	144/cs.

Product Index

Index	
2	Dye Sheets
100	Dye Carpet
100	Dye Mop Frames
70	Dye Mop Handles
102	Dye Mop
102	Dye Mop
77	Dye Mop
71	Dye Mop
100	Dyeing Brush
148	148
146	146
103	103
101	101
100	100
102	102
102	102
2	2

A

Absorbent	114 JS
Absorbent Pads	330 FS
Aerosol Deodorants/Systems	73 JS-76 JS
Aerosol Disinfectants	.61 JS, 62 JS
Air Fresheners	73 JS-77 JS
All Purpose Cleaners	.19 GS, 20 GS, 35 JS-41 JS
Aluminum Foil	.324 FS, 325 FS
Aluminum Food Containers	.293 FS-295 FS
Amenities	103 JS
Angle Brooms	169 JS
Ant/Roach Killer	.79 JS, 80 JS
Anti-Fatigue Matting	.33 GS, 219 JS
Apparel, Disposable	.147 JS-155 JS, 331 FS-336 FS
Apron Gowns	.154 JS, 336 FS
Aprons, Disposable	.153 JS, 335 FS
Ash/Trash Containers	.211 JS
Automotive Treatments	.82 JS

B

Baby Changing Station/Liners	145 JS
Backpack Vacuums	.217 JS
Bags	
Bakery	.311 FS, 312 FS
Caddy	.210 JS
Compostable	.31 GS, 199 JS
Drawtape	.309 FS
Foil	.311 FS
Food	.312 FS-314 FS
Grocery	.307 FS, 308 FS
Ice	.315 FS
Lawn & Leaf	.199 JS
Liquor	.308 FS
Merchandise	.308 FS, 309 FS
Paper	.307 FS-311 FS
Poly	.311 FS-317 FS
Produce	.314 FS
Reusable	.17 GS
Sandwich	.18 GS, 314 FS, 315 FS
Shopping	.17 GS
Trash	.31 GS, 193 JS-199 JS
T-Shirt	.17 GS, 315 FS
Zip Closure	.316 FS, 317 FS
Bakery Bags	.311 FS, 312 FS
Bakery Boxes	.15 GS, 302 FS
Bakery Packaging	.303 FS-306 FS
Bakery Tissue	.323 FS
Baking Cups	.323 FS
Bar Glass Sanitizers	.55 JS, 56 JS
Bar Soap	.85 JS
Barrel Sacks	.307 FS, 308 FS
Baskets, Berry	.298 FS
Bath Mats	145 JS
Bath Towels	145 JS
Bathroom Cleaners	.21 GS, 22 GS, 64 JS-66 JS

Beard Guards	153 JS, 334 FS
Bench Brushes	167 JS
Berry Baskets	.298 FS
Beverage Carriers	.301 FS, 302 FS
Beverage Napkins	.12 GS, 13 GS, 265 FS
Blade Dispensers	188 JS
Bleach	.59 JS
Bonnets, Carpet	.217 JS
Bottles, Spray	189 JS
Bouffant Caps	152 JS, 334 FS
Bowl Brushes	167 JS
Bowl Cleaners	.67 JS-70 JS
Boxes, Bakery	15 GS, 302 FS
Boxes, Pizza	.298 FS
Brooms	
Braces	.171 JS
Handles	.171 JS, 172 JS
Angle	169 JS
Corn	168 JS
Push	.170 JS, 171 JS
Brushes	
Bowl	167 JS
Counter	167 JS
Scrub	166 JS
Vehicle Wash	167 JS
Bucket/Wringer Combos	.31 GS, 185 JS-187 JS
Buckets, Mop	185 JS
Buckets/Pails	189 JS
Bun Pan Covers	312 FS
Bussing Carts	190 JS
Butcher Paper	319 FS
C	
Caddies, Maid	192 JS
Caddies, Rim	210 JS
Caddy Bags	210 JS
Cafeteria Trays	.16 GS, 300 FS, 301 FS
Cake Circles/Boards	.302 FS, 303 FS
Cake Packaging	.303 FS, 304 FS
Can Liners	.31 GS, 193 JS-199 JS
Candles	.262 FS
Carpet	
Bonnets	.217 JS
Cleaners	.24 GS, 115 JS, 116 JS
Defoamers	.118 JS
Deodorizers	.118 JS
Spotters	.24 GS, 116 JS, 117 JS
Sweepers	.218 JS
Carts	
Bussing	190 JS
Cleaning	191 JS
Equipment	192 JS
Janitor	191 JS
Utility	190 JS, 191 JS
Case Liners	.328 FS

Caterware	.271 FS, 272 FS
Cellulose Sponges	.162 JS
Centerpull Towel Dispensers	141 JS
Centerpull Towels	.27 GS, 131 JS
C-Fold Towels	.27 GS, 28 GS, 133 JS, 134 JS
Chafing Fuel	.262 FS
Changing Station	145 JS
Chemical Dilution Systems	.77 JS-79 JS
Cigarette Receptacles	.211 JS
Cleaners	
All Purpose	.19 GS, 20 GS, 35 JS-41 JS
Bowl	.67 JS-70 JS
Carpet	.24 GS, 115 JS, 116 JS
Coil	.83 JS
Concrete	.107 JS
Electronics	.49 JS
Floor	.23 GS, 24 GS, 105 JS, 106 JS
Freezer	.41 JS, 42 JS
Fryer	.52 JS
Glass	.21 GS, 46 JS-49 JS
Hand	.22 GS, 23 GS
Oven/Grill	.51 JS, 52 JS
Pine	.41 JS
Restroom	.21 GS, 22 GS, 64 JS-66 JS
Tile/Stone	.66 JS, 67 JS, 107 JS, 108 JS
Wood	.106 JS
Cleaning Carts	191 JS
Cleaning Wipes	.160 JS-162 JS
Cling Film	.326 FS-328 FS
Closet Organizers	190 JS
Coffee/Filters	.262 FS, 263 FS
Coil Cleaners	.83 JS
Cold Cup Lids	.239 FS-241 FS
Compostable Bags	.31 GS, 199 JS
Concrete Cleaners	.107 JS
Cone Cups	.243 FS
Containers	
Ash/Trash	211 JS
Food	.13 GS-16 GS, 272 FS-306 FS
Popcorn	.296 FS
Recycling	.32 GS, 206 JS-209 JS
Takeout	.297 FS, 298 FS
Trash	.32 GS, 201 JS-209 JS
Controlled Roll Towels	130 JS
Cookie Packaging	.305 FS, 306 FS
Corn Brooms	168 JS
Corn Dog Sticks	.247 FS
Counter Brushes	167 JS

Index	
2	Dye Sheets
126	Dye Carpet
128	Dust Mop Frames
76	Dust Mop Handles
103	Dust Mop Footrest
102	Dust Mop
116	Dust Pans
2	Dusters
11	Dishes, Suffer
129	Dusting Brush
148	150
158	
48	150
151	151
100	151
102	154
152	152

Product Index

Cup Dispensers	.246 FS
Cup Lids	.239 FS-243 FS
Cupcake Packaging	.305 FS, 306 FS
Cups	
Baking	.323 FS
Cone	.243 FS
Foam	.238 FS, 239 FS
Paper	.231 FS-234 FS
Plastic	.234 FS-237 FS
Poly Lactic Acid (PLA)	.10 GS, 11 GS, 233 FS, 235 FS
Recycled Paper	.10 GS, 11 GS, 231 FS, 233 FS
Recycled Plastic	.10 GS, 236 FS
Soufflé	.244 FS-246 FS
Water	.243 FS, 244 FS
Cut-End Mops	.31 GS, 180 JS-182 JS
Cutlery Kits	.259 FS, 260 FS
Cutlery, Disposable	.9 GS, 10 GS, 251 FS-258 FS
D	
Deck Mops	.182 JS, 183 JS
Deck/Floor Brushes	.167 JS, 168 JS
Defoamers	.118 JS
Degreasers	.19 GS, 20 GS, 42 JS-45 JS
Deli Containers/Lids	.287 FS-289 FS
Deli Paper	.18 GS, 320 FS-322 FS
Delimers	.66 JS, 67 JS
Deodorant Blocks	.71 JS
Deodorant Systems	.74 JS-77 JS
Deodorants, Aerosol	.73 JS, 74 JS
Deodorants, Liquid	.22 GS, 72 JS, 73 JS
Deodorants, Scented Oil	.74 JS
Deodorizers, Carpet	.118 JS
Dessert Dishes	.289 FS
Detergent, Laundry	.57 JS-59 JS
Dilution Control Systems	.77 JS-79 JS
Dinner Napkins	.12 GS, 13 GS, 267 FS, 268 FS
Dinnerware	
Eco-Friendly	.7 GS-9 GS, 222 FS-226 FS
Foam	.227 FS-230 FS
Paper	.221 FS-226 FS
Plastic	.226 FS, 227 FS
Dishwash, Hand	.21 GS, 52 JS-55 JS
Dishwash, Machine	.56 JS
Disinfectants, Aerosol	.61 JS, 62 JS
Disinfectants, Liquid	.21 GS, 62 JS-64 JS
Disinfecting Wipes	.160 JS-162 JS
Dispenser Napkins	.12 GS, 13 GS, 265 FS-267 FS
Dispensers	
Cup	.246 FS
Napkin	.269 FS
Paper Towel	.138 JS-142 JS
Pump	.189 JS
Toilet Seat Cover	.144 JS
Toilet Tissue	.124 JS-126 JS

Dollies	.250 FS
Dollies	.209 JS, 210 JS
Drain Treatments	.70 JS
Drawtape Bags	.309 FS
Drum Pumps	.189 JS
Dryer Sheets	.60 JS
Dust Masks	.153 JS
Dust Mop Treatments	.107 JS
Dust Mops/Frames/Handles	.175 JS, 176 JS
Dust Pans	.172 JS
Dusting Cloths	.172 JS-174 JS
Dusting Tools	.29 GS-31 GS, 172 JS-174 JS
E	
Electronics Cleaner	.49 JS
Equipment Carts	.192 JS
Exam Gloves	.151 JS
F	
Fabric Softeners	.60 JS
Facial Tissue	.26 GS, 126 JS-128 JS
Feminine Hygiene	.29 GS, 142 JS-144 JS
Film Rolls/Sheets	.325 FS-328 FS
Filters, Coffee	.263 FS
Filters, Grease	.264 FS
Floor	
Cleaners	.23 GS, 24 GS, 105 JS, 106 JS
Finish	.24 GS, 110 JS-114 JS
Finish Systems	.187 JS
Pads	.215 JS-217 JS
Signage	.187 JS, 188 JS
Squeegees	.188 JS
Stripper	.24 GS, 108 JS, 109 JS
Sweepers	.218 JS
Sweeps	.170 JS, 171 JS
Foam	
Cups	.238 FS, 239 FS
Dinnerware	.227 FS-230 FS
Food Containers	.290 FS-293 FS
Soap	.22 GS, 23 GS, 92 JS, 93 JS
Trays	.328 FS, 329 FS
Foil Bags	.311 FS
Foil Rolls/Sheets	.324 FS
Folded Towel Dispensers	.141 JS, 142 JS
Food Bags	.312 FS-314 FS
Food Buckets/Tubs	.296 FS
Food Containers	
Aluminum	.293 FS-295 FS
Eco-Friendly	.13 GS-16 GS
Foam	.290 FS-293 FS
Paper	.272 FS-277 FS
Plastic	.277 FS-289 FS
Food Pans	.263 FS
Food Trays	.15 GS-17 GS, 298 FS-300 FS

Foodservice Film/Cutters	.325 FS-328 FS
Freezer Cleaners	.41 JS, 42 JS
Freezer Paper	.319 FS
French Fry Cartons	.296 FS
Frill Picks	.247 FS
Fryer Cleaners	.52 JS
Fuel	.262 FS
Furniture Polish	.49 JS, 50 JS
G	
Garbage Bags	.31 GS
Gel/Solid Deodorant Systems	.76 JS, 77 JS
Glass Cleaners	.21 GS, 46 JS-49 JS
Gloves, Disposable	.147 JS-151 JS, 331 FS-333 FS
Gloves, Reusable	.152 JS, 333 FS
Gloves, Work	.155 JS
Graffiti/Vandal Mark Removers	.46 JS
Grease Filters/holders	.264 FS
Griddle Pads/holders	.166 JS
Griddle Screens	.166 JS
Grill Bricks	.166 JS
Grocery Bags	.307 FS, 308 FS
Guest Checks	.260 FS, 261 FS
H	
Hair/Body Shampoo	.96 JS, 103 JS
Hairnets	.152 JS, 334 FS
Hand Cleaners	.22 GS, 23 GS
Hand Dishwash	.21 GS, 52 JS-55 JS
Hand Sanitizers	.23 GS, 97 JS-99 JS
Hand Tools	.188 JS
Hand/Body Wipes	.99 JS, 100 JS
Handles	
Broom	.171 JS, 172 JS
Dust Mop	.176 JS
Microfiber Mop	.177 JS, 178 JS
Wet Mop	.183 JS
High Chair	.264 FS
Hinged Containers	.14 GS, 15 GS
Hot Cup Lids	.241 FS-243 FS
Hot Cup Sleeves	.11 GS, 234 FS
HVAC Treatments	.83 JS
I	
Ice Bags	.315 FS
Ice Melt	.114 JS
Indoor Matting	.33 GS, 219 JS
Industrial Soap	.94 JS, 95 JS
Ingredient Bins	.264 FS
Insect Control System	.79 JS
Insect Repellent	.80 JS, 81 JS
Insecticides	.79 JS, 80 JS
Instrument Carts	.192 JS

Product Index

Index	
2	Dryer Sheets
100	Dryer Carpet
100	Dust Mop Frames
70	Dust Mop Handles
102	Dust Mop Heads
102	Dust Mops
77	Dust Pads
2	Dusters
71	Dusters - Quilted
100	Dusting Brush
144	100
146	146
153	153
151	Electronics Cleaner
100	Etcher/Marking
102	Exam Gloves
2	Etcher/Marking
2	Etcher/Marking

J
Janitor Carts191 JS

K
Kitchen Roll Towels132 JS, 133 JS
Kleenex26 GS, 126 JS-128 JS
Knee Pads155 JS
Knit Gloves155 JS
Kraft Paper319 FS

L
Ladder Carts192 JS
Latex Gloves150 JS, 333 FS
Laundry Detergent57 JS-59 JS
Lawn & Leaf Bags199 JS
Lids, Cup239 FS-243 FS
Linens
 Baby Changing Station145 JS
 Can31 GS, 193 JS-199 JS
 Meat Case328 FS
 Napkin Receptacle29 GS, 143 JS
 Pan18 GS, 322 FS, 323 FS
Liquid Deodorants22 GS, 72 JS, 73 JS
Liquid Disinfectants62 JS-64 JS
Liquid Soap86 JS
Liquor Bags308 FS
Looped-End Mops179 JS, 180 JS
Lotion100 JS
Lotion Soap90 JS, 91 JS
Lubricants81 JS, 82 JS
Luncheon Napkins265 FS-267 FS

M
Machine Dishwash56 JS
Maid Caddies192 JS
Matting33 GS, 218 JS, 219 JS
Meat Film326 FS-328 FS
Meat Trays/Pads328 FS-330 FS
Meat/Dairy Case Liners328 FS
Medicated Soap87 JS-89 JS
Merchandise Bags308 FS, 309 FS
Metal Polish50 JS, 51 JS
Microfiber Cloths/Dusters29 GS, 30 GS, 173 JS, 174 JS
Microfiber Floor Cleaning Systems177 JS, 178 JS
Microfiber Mops/Frames/Handles30 GS, 31 GS,176 JS-178 JS
Mobile Work Center192 JS
Moist Towelettes100 JS
Mop Bucket/Wringer Combos31 GS, 185 JS-187 JS
Mop Buckets31 GS, 185 JS
Mop Handles183 JS
Mop Wringers184 JS
Mops
 Cut-End31 GS, 180 JS-182 JS
 Deck182 JS, 183 JS

Looped-End179 JS, 180 JS
Microfiber30 GS, 31 GS
Sponge183 JS, 184 JS
Mouse Traps81 JS
Muffin Packaging305 FS, 306 FS
Multifold Towels28 GS, 135 JS-137 JS

N
Napkin Bands269 FS
Napkin Dispensers269 FS
Napkin Receptacle Liners29 GS, 143 JS
Napkins
 Beverage12 GS, 13 GS, 265 FS
 Dinner12 GS, 13 GS, 267 FS, 268 FS
 Dispenser12 GS, 13 GS, 265 FS-267 FS
 Luncheon265 FS-267 FS
 Sanitary29 GS, 142 JS
Neutral Floor Cleaners109 JS, 110 JS
Nitrile Gloves151 JS, 333 FS

O
Oven Mitts155 JS
Oven/Grill Cleaners51 JS, 52 JS

P
Pallet Wrap330 FS
Pan Liners18 GS, 322 FS, 323 FS
Pan Rack Covers317 FS
Paper
 Bags307 FS-311 FS
 Butcher319 FS
 Cups231 FS-234 FS
 Deli320 FS-322 FS
 Dinnerware221 FS-226 FS
 Food Containers272 FS-277 FS
 Freezer319 FS
 Kraft319 FS
 Patty320 FS
 Steak320 FS
 Towel Dispensers138 JS-142 JS
 Towels26 GS-29 GS, 128 JS-138 JS

Parchment Sheets322 FS, 323 FS
Patty Paper320 FS
Picks247 FS
Pie Packaging305 FS
Pine Cleaners41 JS
Pizza Box Lid Supports298 FS
Pizza Boxes298 FS
Pizza Trays298 FS
Placemats269 FS, 270 FS
Plant Sleeves314 FS
Plastic
 Cups234 FS-237 FS
 Dinnerware226 FS, 227 FS
 Food Containers277 FS-289 FS

Plates, Disposable7 GS-9 GS, 221 FS-230 FS
Platform Trucks213 JS, 214 JS
Platters, Disposable7 GS, 8 GS, 221 FS-230 FS
Polish, Furniture49 JS, 50 JS
Polish, Metal50 JS, 51 JS
Poly Bags311 FS-317 FS
Poly Lactic Acid (PLA) Cups235 FS
Popcorn Containers296 FS
Portion Cups/Lids15 GS, 244 FS-246 FS
Powdered Soap85 JS, 86 JS
Produce Bags314 FS
Produce Film326 FS-328 FS
Pump Dispensers189 JS
Push Brooms170 JS, 171 JS

R
Rack Covers317 FS
Razor103 JS
ReadyMop™ Floor Cleaning System184
Receptacles
 Ash/Trash211 JS
 Sanitary Napkin143 JS
 Recycling32 GS, 206 JS-209 JS
 Smoking211 JS, 212 JS
 Waste32 GS, 201 JS-209 JS
Reclosable Bags316 FS, 317 FS
Recycling Containers32 GS, 206 JS-209 JS
Register Rolls261 FS, 262 FS
Restroom Cleaners21 GS, 22 GS, 64 JS-66 JS
Reusable Bags17 GS
Reusable Gloves152 JS, 333 FS
Rim Caddy210 JS
Rim Cages71 JS
Rodent Control81 JS
Roll Towel Dispensers138 JS-140 JS
Roll Towels26 GS, 27 GS, 128 JS-130 JS, 132 JS, 133 JS
Rubber Bands262 FS
Rubber Protectant83 JS

Index	
2	Dye Sheets
126	Dye Carpet
129	Dust Mop Frames
76	Dust Mop Handles
103	Dust Mop Headrest
162	Dust Mop
116	Dust Pans
116	Dust Pans
2	Dusters
129	Dusting Brushes
148	158
150	151
100	101
102	103
104	105
106	107
108	109
110	111
112	113
114	115
116	117
118	119
120	121
122	123
124	125
126	127
128	129
130	131
132	133
134	135
136	137
138	139
140	141
142	143
144	145
146	147
148	149
150	151
152	153
154	155
156	157
158	159
160	161
162	163
164	165
166	167
168	169
170	171
172	173
174	175
176	177
178	179
180	181
182	183
184	185
186	187
188	189
190	191
192	193
194	195
196	197
198	199
200	201
202	203
204	205
206	207
208	209
210	211
212	213
214	215
216	217
218	219
220	221
222	223
224	225
226	227
228	229
230	231
232	233
234	235
236	237
238	239
240	241
242	243
244	245
246	247
248	249
250	251
252	253
254	255
256	257
258	259
260	261
262	263
264	265
266	267
268	269
270	271
272	273
274	275
276	277
278	279
280	281
282	283
284	285
286	287
288	289
290	291
292	293
294	295
296	297
298	299
300	301
302	303
304	305
306	307
308	309
310	311
312	313
314	315
316	317
318	319
320	321
322	323
324	325
326	327
328	329
330	331
332	333
334	335
336	337
338	339
340	341
342	343
344	345
346	347
348	349
350	351
352	353
354	355
356	357
358	359
360	361
362	363
364	365
366	367
368	369
370	371
372	373
374	375
376	377
378	379
380	381
382	383
384	385
386	387
388	389
390	391
392	393
394	395
396	397
398	399
400	401
402	403
404	405
406	407
408	409
410	411
412	413
414	415
416	417
418	419
420	421
422	423
424	425
426	427
428	429
430	431
432	433
434	435
436	437
438	439
440	441
442	443
444	445
446	447
448	449
450	451
452	453
454	455
456	457
458	459
460	461
462	463
464	465
466	467
468	469
470	471
472	473
474	475
476	477
478	479
480	481
482	483
484	485
486	487
488	489
490	491
492	493
494	495
496	497
498	499
500	501
502	503
504	505
506	507
508	509
510	511
512	513
514	515
516	517
518	519
520	521
522	523
524	525
526	527
528	529
530	531
532	533
534	535
536	537
538	539
540	541
542	543
544	545
546	547
548	549
550	551
552	553
554	555
556	557
558	559
560	561
562	563
564	565
566	567
568	569
570	571
572	573
574	575
576	577
578	579
580	581
582	583
584	585
586	587
588	589
590	591
592	593
594	595
596	597
598	599
600	601
602	603
604	605
606	607
608	609
610	611
612	613
614	615
616	617
618	619
620	621
622	623
624	625
626	627
628	629
630	631
632	633
634	635
636	637
638	639
640	641
642	643
644	645
646	647
648	649
650	651
652	653
654	655
656	657
658	659
660	661
662	663
664	665
666	667
668	669
670	671
672	673
674	675
676	677
678	679
680	681
682	683
684	685
686	687
688	689
690	691
692	693
694	695
696	697
698	699
700	701
702	703
704	705
706	707
708	709
710	711
712	713
714	715
716	717
718	719
720	721
722	723
724	725
726	727
728	729
730	731
732	733
734	735
736	737
738	739
740	741
742	743
744	745
746	747
748	749
750	751
752	753
754	755
756	757
758	759
760	761
762	763
764	765
766	767
768	769
770	771
772	773
774	775
776	777
778	779
780	781
782	783
784	785
786	787
788	789
790	791
792	793
794	795
796	797
798	799
800	801
802	803
804	805
806	807
808	809
810	811
812	813
814	815
816	817
818	819
820	821
822	823
824	825
826	827
828	829
830	831
832	833
834	835
836	837
838	839
840	841
842	843
844	845
846	847
848	849
850	851
852	853
854	855
856	857
858	859
860	861
862	863
864	865
866	867
868	869
870	871
872	873
874	875
876	877
878	879
880	881
882	883
884	885
886	887
888	889
890	891
892	893
894	895
896	897
898	899
900	901
902	903
904	905
906	907
908	909
910	911
912	913
914	915
916	917
918	919
920	921
922	923
924	925
926	927
928	929
930	931
932	933
934	935
936	937
938	939
940	941
942	943
944	945
946	947
948	949
950	951
952	953
954	955
956	957
958	959
960	961
962	963
964	965
966	967
968	969
970	971
972	973
974	975
976	977
978	979
980	981
982	983
984	985
986	987
988	989
990	991
992	993
994	995
996	997
998	999
1000	1001

Product Index

PRODUCT INDEX

S

Safety Cones	188 JS
Sandwich Bags	18 GS, 314 FS, 315 FS
Sandwich Wrap	320 FS-322 FS
Sanitary Napkin Receptacles	143 JS
Sanitary Napkins	29 GS, 142 JS
Sanitizers	
Bar Glass	55 JS, 56 JS
Hand	23 GS, 97 JS-99 JS
Surface	45 JS, 46 JS
Warewashing	57 JS
Scented Oil Deodorants	74 JS
Scouring Pads	163 JS, 164 JS
Scraper Matting	33 GS, 218 JS
Scrapers	188 JS
Scrub Brushes	166 JS
Scrubber Sponges	162 JS, 163 JS
Scrubbers, Stainless Steel	165 JS
Seat Covers, Toilet	144 JS
Shampoo & Conditioner	103 JS
Shampoo, Hair/Body	96 JS, 103 JS
Shampoo, Vehicle	25 GS, 82 JS, 83 JS
Shopping Bags	17 GS
Signage	187 JS, 188 JS
Singlefold Towels	29 GS, 137 JS, 138 JS
Skewers	247 FS
Sleeves, Disposable	155 JS, 336 FS
Sleeves, Hot Cup	11 GS, 234 FS
Smocks, Disposable	154 JS, 336 FS
Smoking Receptacles	211 JS, 212 JS
Soap	
Dispensers	100 JS-103 JS
Bar	85 JS
Foam	22 GS, 23 GS, 92 JS, 93 JS
Industrial	94 JS, 95 JS
Liquid	86 JS
Lotion	90 JS, 91 JS
Medicated	87 JS-89 JS
Powdered	85 JS, 86 JS
Soufflé Cups/Lids	15 GS, 244 FS-246 FS
Spatulas	263 FS
Sponge Mops	183 JS, 184 JS
Sponges, Cellulose	162 JS
Sponges, Scrubber	162 JS, 163 JS
Spotters, Carpet	24 GS, 116 JS, 117 JS
Spray Bottles	189 JS
Sprayers	189 JS
Square Edge Sticks	247 FS
Squeegees	188 JS
Stain Removers	60 JS, 116 JS, 117 JS
Stainless Steel Polish	50 JS, 51 JS
Stainless Steel Scrubbers	165 JS
Steak Paper	320 FS
Steamtable Pans/Lids	295 FS

Steel Wool Pads	165 JS
Step Stools	190 JS
Stirrers	247 FS
Straws	11 GS, 248 FS-250 FS
Stripper, Floor	24 GS, 108 JS, 109 JS
Sweepers	218 JS
Sweeping Compound	114 JS

T

Tablecovers	13 GS, 270 FS
Takeout Containers	297 FS, 298 FS
Tampons	142 JS
Tile/Stone Cleaners	66 JS, 67 JS, 107 JS, 108 JS
Tire Dressing	82 JS
To-Go Cups	296 FS
Toilet Bowl Brushes	167 JS
Toilet Seat Bands	144 JS
Toilet Seat Cover Dispensers	144 JS
Toilet Seat Covers	29 GS, 144 JS
Toilet Tissue	
Controlled Use	124 JS
Dispensers	124 JS-126 JS
Folded	124 JS
Jumbo	25 GS, 122 JS-124 JS
Standard	25 GS, 119 JS-121 JS
Tool Holders	190 JS
Toothpicks	247 FS
Towels	
Dispensers	138 JS-142 JS
Bath	145 JS
Centerpull	27 GS, 131 JS
C-Fold	27 GS, 28 GS, 133 JS, 134 JS
Multifold	28 GS, 135 JS-137 JS
Roll	26 GS, 27 GS, 128 JS-130 JS, 132 JS, 133 JS
Singlefold	29 GS, 137 JS, 138 JS
Trash Bags	31 GS, 193 JS-199

Vendor Numeric Index

Index	
2	Dye Sheets
100	Dye Cartridge
101	Dye Ink
102	Dye Ink Cartridge
103	Dye Ink Refill
104	Dye Ink Tank
105	Dye Ink Tray
106	Dye Ink Unit
107	Dye Ink Vial
108	Dye Ink Bottle
109	Dye Ink Cartridge
110	Dye Ink Cartridge
111	Dye Ink Cartridge
112	Dye Ink Cartridge
113	Dye Ink Cartridge
114	Dye Ink Cartridge
115	Dye Ink Cartridge
116	Dye Ink Cartridge
117	Dye Ink Cartridge
118	Dye Ink Cartridge
119	Dye Ink Cartridge
120	Dye Ink Cartridge
121	Dye Ink Cartridge
122	Dye Ink Cartridge
123	Dye Ink Cartridge
124	Dye Ink Cartridge
125	Dye Ink Cartridge
126	Dye Ink Cartridge
127	Dye Ink Cartridge
128	Dye Ink Cartridge
129	Dye Ink Cartridge
130	Dye Ink Cartridge
131	Dye Ink Cartridge
132	Dye Ink Cartridge
133	Dye Ink Cartridge
134	Dye Ink Cartridge
135	Dye Ink Cartridge
136	Dye Ink Cartridge
137	Dye Ink Cartridge
138	Dye Ink Cartridge
139	Dye Ink Cartridge
140	Dye Ink Cartridge
141	Dye Ink Cartridge
142	Dye Ink Cartridge
143	Dye Ink Cartridge
144	Dye Ink Cartridge
145	Dye Ink Cartridge
146	Dye Ink Cartridge
147	Dye Ink Cartridge
148	Dye Ink Cartridge
149	Dye Ink Cartridge
150	Dye Ink Cartridge
151	Dye Ink Cartridge
152	Dye Ink Cartridge
153	Dye Ink Cartridge
154	Dye Ink Cartridge
155	Dye Ink Cartridge
156	Dye Ink Cartridge
157	Dye Ink Cartridge
158	Dye Ink Cartridge
159	Dye Ink Cartridge
160	Dye Ink Cartridge
161	Dye Ink Cartridge
162	Dye Ink Cartridge
163	Dye Ink Cartridge
164	Dye Ink Cartridge
165	Dye Ink Cartridge
166	Dye Ink Cartridge
167	Dye Ink Cartridge
168	Dye Ink Cartridge
169	Dye Ink Cartridge
170	Dye Ink Cartridge
171	Dye Ink Cartridge
172	Dye Ink Cartridge
173	Dye Ink Cartridge
174	Dye Ink Cartridge
175	Dye Ink Cartridge
176	Dye Ink Cartridge
177	Dye Ink Cartridge
178	Dye Ink Cartridge
179	Dye Ink Cartridge
180	Dye Ink Cartridge
181	Dye Ink Cartridge
182	Dye Ink Cartridge
183	Dye Ink Cartridge
184	Dye Ink Cartridge
185	Dye Ink Cartridge
186	Dye Ink Cartridge
187	Dye Ink Cartridge
188	Dye Ink Cartridge
189	Dye Ink Cartridge
190	Dye Ink Cartridge
191	Dye Ink Cartridge
192	Dye Ink Cartridge
193	Dye Ink Cartridge
194	Dye Ink Cartridge
195	Dye Ink Cartridge
196	Dye Ink Cartridge
197	Dye Ink Cartridge
198	Dye Ink Cartridge
199	Dye Ink Cartridge
200	Dye Ink Cartridge

Mfg. #	#	Pg. #	Mfg. #	#	Pg. #	Mfg. #	#	Pg. #	Mfg. #	#	Pg. #	Mfg. #	#	Pg. #
2979304	15200176	58 JS	48030	15208130	42 JS	CB003905	15200390	316 FS	80083	132000515	308 FS	FORTUNE PLASTICS		
2979401	15200116	86 JS	4806	15204806	75 JS	CB003971	15204431	49 JS	80091	13200058	308 FS	100NP	13800150	314 FS
2979460	15200117	54 JS	4809	15204809	75 JS	CB003995	15209439	49 JS	80193	13200043	309 FS	101NP	13807305	314 FS
2979486	15200155	54 JS	4832	15204832	61 JS	CB006965	15204923	76 JS	80201	13200001	309 FS	109NP	13801065	314 FS
2979558	15200121	56 JS	4956341	15206341	109 JS	CB013536	15209489	79 JS	80218	13200000	308 FS	12205SW	13805300	314 FS
2979646	15200123	59 JS	4965	15204965	78 JS	CB016605	15209490	79 JS	80221	13200002	309 FS	127NP	13801105	314 FS
2979662	15200125	88 JS	4970590	15205090	50 JS	CB018104	15201810	80 JS	80233	13200023	309 FS	127NPH	13801115	314 FS
2979814	15200158	59 JS	4974776	15200396	79 JS	CB018357	15204912	80 JS	80243	13201101	309 FS	127NPM	13801110	314 FS
2979831	15200128	85 JS	4994	15203846	78 JS	CB018425	15200146	80 JS	80273	13200273	309 FS	130NP	13801150	314 FS
2979890	15200130	58 JS	4996	15204996	68 JS	CB022460	15200104	60 JS	80279	13200004	309 FS	160NP	13800002	312 FS
2979929	15200132	60 JS	5032360	15205032	109 JS	CB022514	15200137	60 JS	80288	13200073	309 FS	3858175YEL	13803817	196 JS
2979945	15200180	58 JS	5104714	15204715	112 JS	CB028653	15200173	73 JS	80293	13200048	309 FS	4456XXGR	13804456	196 JS
2979953	15200134	60 JS	5104773	15200441	112 JS	CB028684	15200174	73 JS	80304	13200006	309 FS	5040CLR	13805040	196 JS
2979996	15200136	60 JS	5104811	15200440	112 JS	CB079001	07519001	100 JS	80695	132010015	309 FS	91380023	13800029	314 FS
2980196	15200011	88 JS	5104829	57084829	113 JS	CB121286	15200166	49 JS	80775	13200775	309 FS	B3339XH	13800274	197 JS
3006390	15203390	110 JS	5104917	15204917	112 JS	CB153478	15205347	76 JS	80957	13200018	307 FS	B3339XXH	13800270	197 JS
3143453	57080436	78 JS	5104950	15200435	113 JS	CB168571	15208571	73 JS	80958	13200019	307 FS	B3858XXH	13800273	197 JS
3145310	15205310	78 JS	5105047	15200434	113 JS	CB179058	15200328	73 JS	80959	13200023	307 FS	B4046XH	13800071	197 JS
3172641	15202641	78 JS	5115958	15205958	109 JS	CB182628	15200187	37 JS	80960	13200024	307 FS	B4046XXH	13800272	197 JS
3172650	15202650	78 JS	5120888	15200439	112 JS	CB214629	15204629	49 JS	80961	13200025	307 FS	B4347XH	13800280	197 JS
3191746	15201746	79 JS	5120888	15200439	112 JS	CB216135	15204400	79 JS	80962	13200026	307 FS	BC48	13800113	197 JS
3313117	15200210	78 JS	5120888	15200439	112 JS	CB232327	15202237	65 JS	80963	13200027	307 FS	BC60	13800115	197 JS
3318102	57083971	78 JS	90129	15200080	47 JS	CB327126	15203271	85 JS	80964	13200034	307 FS	BCH40	13800433	197 JS
3329364	57083920	78 JS	90135	15200161	47 JS	CB549967	15204905	80 JS	80965	13200037	307 FS	BCH47	13800210	197 JS
3329381	57083967	78 JS	90139	15200082	47 JS	CB610795	15200015	85 JS	80966	13200038	307 FS	BCH48	13800446	197 JS
3357005	15207005	77 JS	90156	15200183	67 JS	CB614243	15200044	85 JS	80967	13200039	307 FS	BCH60	13800114	197 JS
3358964	15206410	90 JS	90157	15200238	69 JS	CB663281	15203281	173 JS	80968	13200040	307 FS	BCRD4048X	13800291	196 JS
3401512	15201512	78 JS	90158	15200148	69 JS	CB701106	15200398	47 JS	80969	13200041	307 FS	BCX40	13800439	197 JS
3481049	15201049	78 JS	90201	15200092	56 JS	CB701380	15200380	38 JS	80970	13200070	307 FS	BCX47	13800271	197 JS
3481057	15201057	78 JS	90203	15200093	55 JS	CB701397	15200384	38 JS	80976	13200178	307 FS	BCX48	13800484	197 JS
3685931	15206424	109 JS	90221	15200094	56 JS	CB701502	15200442	48 JS	80979	13200979	307 FS	BCX60	13800638	197 JS
3702	15207961	38 JS	90222	15207630	56 JS	CB701900	15200445	69 JS	80980	13200980	307 FS	BIO3980R	13800092	31 GS, 199 JS
3719563	15209563	78 JS	90223	15200095	55 JS	CB703123	15200383	49 JS	80982	13200982	307 FS	BIO4685R	13800088	31 GS, 199 JS
3719598	15209598	78 JS	90224	15200096	55 JS	CB815901	15204797	79 JS	80983	13200204	307 FS	BK348GO	13800278	197 JS
3719601	15209601	78 JS	90228	15200013	108 JS	DOPACO			80984	13200206	307 FS	BR24BR	13800400	197 JS
3844	15200001	115 JS	90234	15200153	45 JS	17001	66371701	232 FS	80985	13200985	307 FS	BR335BR	13800410	197 JS
3904	15203904	38 JS	90241	15207650	55 JS	17674	66377674	242 FS	81004	13200209	307 FS	BR33BR	13800411	197 JS
3906	15203906	38 JS	90485	15200147	70 JS	17699	66377699	242 FS	81006	13200340	307 FS	BR37GR	13800422	197 JS
4006110	57086110	108 JS	90650	15200102	67 JS	2856	66372856	239 FS	81007	13200208	307 FS	BR37RD	13800423	197 JS
4033110	57083110	113 JS	90651	15200154	37 JS	2857	66372857	239 FS	81014	13208114	307 FS	BR37YL	13800867	197 JS
4038150	57088150	78 JS	90652	15200103	68 JS	3703	66373703	298 FS	81056	13201056	308 FS	BR40GR	13800455	197 JS
4039110	57089110	105 JS	90653	15200107	110 JS	5802	66375802	299 FS	81158	13201159	308 FS	BR40RD	13800453	197 JS
4043110	57083120	38 JS	90670	15200101	45 JS	5803	66375803	299 FS	81186	13203011	308 FS	BR40YL	13800386	197 JS
4043320	57080088	38 JS	90682	15200184	44 JS	5804	66375804	299 FS	81187	13201225	308 FS	BR48YL	13802748	197 JS
4044150	57084150	78 JS	90940	15200081	47 JS	5811	66375811	299 FS	81223	13200211	307 FS	BR60GR	13800498	197 JS
4078	15203863	113 JS	91206	15200087	51 JS	5813	66375813	299 FS	81232	13201232	307 FS	BR64GR	13800490	197 JS
4116	15204116	113 JS	91208	15200151	51 JS	5814	66375814	299 FS	81248	132012485	307 FS	CB48FLA	13800535	199 JS
4168	15203866	112 JS	91209	15200086	52 JS	5815	66375815	299 FS	81250	13200213	307 FS	CL33BR	13800415	197 JS
4192	15204192	116 JS	91210	15200032	38 JS	5817	66375817	299 FS	81273	13200215	307 FS	CL64YL	13800659	197 JS
4193567	15203567	79 JS	91218	15200083	38 JS	81274	66375817	299 FS	81274	132002165	307 FS	CRHD2022	13800195	196 JS
4193575	15203575	79 JS	91224	15200090	50 JS	5877	66375877	299 FS	81527	13201527	308 FS	CRHD2424R	13802424	196 JS
4193583	15203583	79 JS	91249	15200085	38 JS	6152	66376152	296 FS	8165	13200295	308 FS	CRHD2433H	13800266	

Index	
2	Dyer Sheets
126	Dyer Carpet
128	Dyer Map Frames
75	Dyer Map Handies
103	Dyer Map Mounts
102	Dyer Maps
7	Dyer Pins
116	Dyers
2	Dishes
129	Dishin' Supplies
148	Dishin' Spoons
150	
151	
152	
153	
154	
155	
156	
157	
158	
159	
160	
161	
162	
163	
164	
165	
166	
167	
168	
169	
170	
171	
172	
173	
174	
175	
176	
177	
178	
179	
180	
181	
182	
183	
184	
185	
186	
187	
188	
189	
190	
191	
192	
193	
194	
195	
196	
197	
198	
199	
200	

Vendor Numeric Index

VENDOR NUMERIC INDEX

Mfg. #	Pg. #	Mfg. #	Pg. #	Mfg. #	Pg. #	Mfg. #	Pg. #	Mfg. #	Pg. #	Mfg. #	Pg. #
HDN3037R	13800645	196 JS	HCC16	34789234	10 GS, 231 FS	4338SAGE	15001599	232 FS	G6	15001205	321 FS
HDN3340M	13800603	196 JS	HCD06	34789241	7 GS, 223 FS	438SAGE	15004338	232 FS	G8	15000810	321 FS
HDN3340X	13800607	196 JS	HCD09	34789240	7 GS, 223 FS	434	15006528	320 FS	GS1030	15001936	320 FS
HDN3660H	13800360	196 JS	HCD10	34789238	7 GS, 223 FS	44000	13704000	131 JS	GS1230	15001940	320 FS
HDN374612	13800834	196 JS	HCD12	34789245	7 GS, 223 FS	45SAGE	15001600	231 FS	GW7	15007757	249 FS
HDN3860H	13800650	196 JS	HCD13	34789237	7 GS, 223 FS	45SCDX	15001710	231 FS	HD8050	15008050	299 FS
HDN3860X	13800655	196 JS	HCD39	34789239	7 GS, 223 FS	47046	13707046	144 JS	HD8075	15002210	299 FS
HDN4048M	13800610	196 JS	HCH89	34789246	13 GS, 272 FS	512	15009612	320 FS	HS1000	15002002	323 FS
HDN4048X	13800615	196 JS	HCH83	34789236	13 GS, 272 FS	5310DX	15005311	233 FS	HS551	15000105	249 FS
HDN4348H	13800129	196 JS	HX0193L	34780193	292 FS	5338CD	15006338	233 FS	HS551	15000182	249 FS
HDN4348X	13800620	196 JS	LAM09BK	34780146	229 FS	538DX	15001355	233 FS	JW12	15000452	249 FS
HOB385802	13803855	197 JS	LAM09WH	34780123	229 FS	5342BB	15005343	233 FS	JW7	15007775	249 FS
HVLG334016N	13804017	196 JS	LAM10WH	34780118	229 FS	5342CD	15000575	233 FS	JW74	15000444	249 FS
IC10	13802112	315 FS	LAM11BK	34780145	229 FS	5342DX	15001356	233 FS	KH01	15001501	255 FS
IC25W	13800048	315 FS	LAM13WH	34780117	229 FS	5342DXCOMBO	15005341	232 FS	KH207	15000384	254 FS
IM248WH	13800544	197 JS	LAM39WH	34780111	229 FS	5342DXGNG	15003295	232 FS	KH217	15006815	254 FS
IM33WH	13800449	197 JS	LAM79BK	34780277	229 FS	5356CD	15000576	233 FS	KH51	15002651	255 FS
IM37WH	13800540	197 JS	LW024BK	34782402	228 FS	5356DX	15000052	233 FS	KH517	15002652	254 FS
IM40WH	13800542	197 JS	LNW932	34782420	228 FS	5360CD	15001225	233 FS	KL15	15002995	319 FS
IM48WH	13800548	197 JS	SN100	34782100	290 FS	58SAGE	15001695	231 FS	KL18	15003100	319 FS
IM60WH	13800546	197 JS	SN100SMILE	34782101	290 FS	58SAGE	15001768	231 FS	KL24	15000024	319 FS
PG65251FP	13800237	196 JS	SN103	34781103	290 FS	60BL	15000822	323 FS	KL300SAGE8	15001591	299 FS
SL4048125	13802421	196 JS	SN200	34780176	290 FS	6X	15000904	323 FS	KL500SAGE8	15001693	299 FS
SL4650MDB	13802422	196 JS	SN200BK	34780181	290 FS	702622WNP6	15000064	221 FS	KM207	15002016	254 FS
			SN203	34780173	290 FS	709902WNP9	15009902	221 FS	KM21	15007415	254 FS
			SN220	34782020	290 FS	77SAGE	15001577	231 FS	KM217	15007420	254 FS
			SN223	34780223	290 FS	801200	15001526	320 FS	KM507	15000417	254 FS
			SN225	34780224	290 FS	80MIDGET	15007280	321 FS	KM517	15001990	254 FS
			SN225BK	34780222	290 FS	83MASTER	15007283	321 FS	LO10	15002484	323 FS
			SN227	34780177	290 FS	862491	15000491	321 FS	LQ1212PL	15009850	322 FS
			SN240	34780113	290 FS	891254	15000515	321 FS	LQ1212TOMA	15000432	322 FS
			SN243	34781430	290 FS	891255	15005008	321 FS	NATWHI0108C	15008302	323 FS
			SN243BK	34781431	290 FS	891258	15009415	321 FS	P010BB	15000141	244 FS
						89460	13709461	128 JS	P015	15009915	244 FS
						9114LSRD	15009141	240 FS	P020	15000046	244 FS
						92117	13700134	268 FS	P020BLK	15000190	244 FS
						92954	15002962	244 FS	P032	15003200	244 FS
						92959BE	15002959	233 FS	P032BLK	15000191	244 FS
						9605SAGE	15001694	297 FS	P040	15000134	244 FS
						964SAGE	15001760	297 FS	P040BLK	15000136	244 FS
						965SAGE	15001762	297 FS	P055	15009555	244 FS
						977SAGE	15001976	296 FS	PDL1216FR100	15006696	242 FS
						99979	15008120	226 FS	PDL8FR1000	15000175	242 FS
						99981	15008121	226 FS	PFH53C	15003016	255 FS
						99985	15008122	226 FS	PFM21	15000921	254 FS
						AROCOF0112C	15008350	232 FS	PH1030	15004611	320 FS
						AROREF0108C	15000169	232 FS	PKH53C	15003015	255 FS
						AROREF0112C	15000172	232 FS	PKM21	15003021	254 FS
						AROREF0116C	15000173	232 FS	PL1C	15004001	244 FS
						CH0180DX7	15002182	260 FS	PL2	15000132	244 FS
						CH26C7	15001130	260 FS	PL2C	15000170	244 FS
						CM168	15000168	260 FS	PL4	15000133	244 FS
						CM26NC7	15002628	260 FS	PL4C	15000171	244 FS
						CP10DX	15002219	235 FS	PTH53C	15003017	255 FS
						CP1214	15002214	235 FS	PTM21	15000602	254 FS
						CP12DX	15002221	235 FS	RP1008	15005204	299 FS
						CP16DX	15002222	235 FS	RP2008	15005211	299 FS
						CP9A	15008877	235 FS	RP3008	15005212	299 FS
						D9538	15008010	242 FS	RP3008	15005215	299 FS
						D9538	15009539	242 FS	RP408	15001216	299 FS
						D9542	15002542	242 FS	RP50	15005220	299 FS
						D9542B	15002544	242 FS	RP500	15005225	299 FS
						D9550	15009050	242 FS	RW106	15000017	322 FS
						DD05FL	15007455	289 FS	RW126	15001305	322 FS
						DD08C	15000908	289 FS	RW156	15007227	322 FS
						DL32	15009030	240 FS	RW66	15009645	322 FS
						DL9540	15003540	242 FS	RW86	15007000	322 FS
						DS1	15000100	246 FS	S10	15004910	326 FS
						FG15	15000798	319 FS	S12	15005506	326 FS
						FG18	15000797	319 FS	S15	15000151	326 FS
						FG24	15000819	319 FS	S8	15004920	326 FS
						FH11	15000383	255 FS	SC001	15009692	298 FS
						FH207	15000380	254 FS	SC003	15000694	298 FS
						FH217	15000095	254 FS	SH207	15006814	254 FS
						FH51	15005152	254 FS	SM207	15000245	254 FS
						FH517	15005153	254 FS	SM21	15000077	254 FS
						FM207	15001027	254 FS	SM51	15008051	254 FS
						FM21	15007416	254 FS	SSF51	15008808	255 FS
						FM217	15007419	254 FS	SSK51	15008809	255 FS
						FM507	15000416	254 FS	SSS51	15008807	255 FS
						FM51	15002051	254 FS	SUPLOX18	15005510	319 FS
						FM517	15001992	254 FS	SUPLOX24	15000125	319 FS
						G10	15001915	321 FS	SX12SAGE	15001691	222 FS
						G12	15001210	321 FS	SX12SAGE	15001777	222 FS
						G15	15009650	321 FS	SX6SAGE	15001720	222 FS
									SX9SAGE	15001597	222 FS
									SXB12SCDX	15001779	222 FS
									SXB12SCDX	15001795	222 FS
									SXP10SAGE	15001590	222 FS
									SXP10SCDX	15000059	222 FS
									SXP9SCDX	15000061	222 FS
									T10	15009620	323 FS
									T12	15005812	323 FS
									T6	15005810	323 FS
									TH207	15000387	254 FS
									TH217	15005622	254 FS
									TH51	15005151	255 FS
									TH517	15005154	254 FS
									TM20	15002055	254 FS
									TM207	15002056	254 FS
									TM21	15007417	254 FS
									TM217	15007418	254 FS
									TM507	15000418	254 FS
									TM517	15001991	254 FS
									TP9542	15009545	242 FS
									UX6SAGE	15001724	222 FS
									UX6SAGE	15001774	222 FS
									UX7SAGE	15001725	222 FS
									UX7SCDX	15001775	222 FS
									UX9SAGE	15001690	222 FS
									UX9SAGE	15001776	222 FS
									UX9SAGEPB	15001778	222 FS
									W46	15005036	320 FS
			</								

Vendor Numeric Index

Index	
2	Dye Sheets
100	Dye Cartridges
102	Dye Ink
103	Dye Ink Cartridges
104	Dye Ink Refill Kits
105	Dye Ink Toner
106	Dye Ink Toner Cartridges
107	Dye Ink Toner Refill Kits
108	Dye Ink Toner Refill Kits
109	Dye Ink Toner Refill Kits
110	Dye Ink Toner Refill Kits
111	Dye Ink Toner Refill Kits
112	Dye Ink Toner Refill Kits
113	Dye Ink Toner Refill Kits
114	Dye Ink Toner Refill Kits
115	Dye Ink Toner Refill Kits
116	Dye Ink Toner Refill Kits
117	Dye Ink Toner Refill Kits
118	Dye Ink Toner Refill Kits
119	Dye Ink Toner Refill Kits
120	Dye Ink Toner Refill Kits
121	Dye Ink Toner Refill Kits
122	Dye Ink Toner Refill Kits
123	Dye Ink Toner Refill Kits
124	Dye Ink Toner Refill Kits
125	Dye Ink Toner Refill Kits
126	Dye Ink Toner Refill Kits
127	Dye Ink Toner Refill Kits
128	Dye Ink Toner Refill Kits
129	Dye Ink Toner Refill Kits
130	Dye Ink Toner Refill Kits
131	Dye Ink Toner Refill Kits
132	Dye Ink Toner Refill Kits
133	Dye Ink Toner Refill Kits
134	Dye Ink Toner Refill Kits
135	Dye Ink Toner Refill Kits
136	Dye Ink Toner Refill Kits
137	Dye Ink Toner Refill Kits
138	Dye Ink Toner Refill Kits
139	Dye Ink Toner Refill Kits
140	Dye Ink Toner Refill Kits
141	Dye Ink Toner Refill Kits
142	Dye Ink Toner Refill Kits
143	Dye Ink Toner Refill Kits
144	Dye Ink Toner Refill Kits
145	Dye Ink Toner Refill Kits
146	Dye Ink Toner Refill Kits
147	Dye Ink Toner Refill Kits
148	Dye Ink Toner Refill Kits
149	Dye Ink Toner Refill Kits
150	Dye Ink Toner Refill Kits
151	Dye Ink Toner Refill Kits
152	Dye Ink Toner Refill Kits
153	Dye Ink Toner Refill Kits
154	Dye Ink Toner Refill Kits
155	Dye Ink Toner Refill Kits
156	Dye Ink Toner Refill Kits
157	Dye Ink Toner Refill Kits
158	Dye Ink Toner Refill Kits
159	Dye Ink Toner Refill Kits
160	Dye Ink Toner Refill Kits
161	Dye Ink Toner Refill Kits
162	Dye Ink Toner Refill Kits
163	Dye Ink Toner Refill Kits
164	Dye Ink Toner Refill Kits
165	Dye Ink Toner Refill Kits
166	Dye Ink Toner Refill Kits
167	Dye Ink Toner Refill Kits
168	Dye Ink Toner Refill Kits
169	Dye Ink Toner Refill Kits
170	Dye Ink Toner Refill Kits
171	Dye Ink Toner Refill Kits
172	Dye Ink Toner Refill Kits
173	Dye Ink Toner Refill Kits
174	Dye Ink Toner Refill Kits
175	Dye Ink Toner Refill Kits
176	Dye Ink Toner Refill Kits
177	Dye Ink Toner Refill Kits
178	Dye Ink Toner Refill Kits
179	Dye Ink Toner Refill Kits
180	Dye Ink Toner Refill Kits
181	Dye Ink Toner Refill Kits
182	Dye Ink Toner Refill Kits
183	Dye Ink Toner Refill Kits
184	Dye Ink Toner Refill Kits
185	Dye Ink Toner Refill Kits
186	Dye Ink Toner Refill Kits
187	Dye Ink Toner Refill Kits
188	Dye Ink Toner Refill Kits
189	Dye Ink Toner Refill Kits
190	Dye Ink Toner Refill Kits
191	Dye Ink Toner Refill Kits
192	Dye Ink Toner Refill Kits
193	Dye Ink Toner Refill Kits
194	Dye Ink Toner Refill Kits
195	Dye Ink Toner Refill Kits
196	Dye Ink Toner Refill Kits
197	Dye Ink Toner Refill Kits
198	Dye Ink Toner Refill Kits
199	Dye Ink Toner Refill Kits
200	Dye Ink Toner Refill Kits

Mfg. #	#	Pg. #	Mfg. #	#	Pg. #	Mfg. #	#	Pg. #	Mfg. #	#	Pg. #	Mfg. #	#	Pg. #	Mfg. #	#	Pg. #
455518	35405518	89 JS	9600PL1	35403118	99 JS	310521	17805175	269 FS	20917	15301615	300 FS	82205	15302205	226 FS	82205	15302205	226 FS
500504	35400175	93 JS	9600PL1	35409600	99 JS	310523	17800523	269 FS	20918	15301605	300 FS	82206	15302206	226 FS	82206	15302206	226 FS
509103	35400222	23 GS, 97 JS	960624	35400624	98 JS	310524	17809525	269 FS	20945	15300945	301 FS	82209	15302209	226 FS	82209	15302209	226 FS
512006	35402106	102 JS	960824	35400824	99 JS	310525	17800795	269 FS	20961	15301665	300 FS	82210	15302210	226 FS	82210	15302210	226 FS
515006	35405007	102 JS	962424	35402424	97 JS	310526	17809981	269 FS	20962	15300962	300 FS	82230	15302230	226 FS	82230	15302230	226 FS
515506	35405008	102 JS	962504	35409625	98 JS	500233	17800145	250 FS	20963	15300963	301 FS	82239	15302239	226 FS	82239	15302239	226 FS
5155PL	35405005	102 JS	963124	35403124	98 JS	500234	17800142	250 FS	20968	15300024	301 FS	89002	15309020	227 FS	89002	15309020	227 FS
516006	35405009	102 JS	963912	35409639	98 JS	500235	17800132	250 FS	20969	15301635	301 FS	89107	15300063	274 FS	89107	15300063	274 FS
516103	35406103	93 JS	964912	35409649	97 JS	500236	17800131	250 FS	20972	15301650	301 FS	89112	15309112	274 FS	89112	15309112	274 FS
516203	35406203	92 JS	965124	35409652	98 JS	500238	17800137	250 FS	20974	15301640	301 FS						
516303	35406303	96 JS	965212	35405212	98 JS	500239	17800146	250 FS	20975	15300202	301 FS						
516503	35405166	22 GS, 93 JS	965412	35409653	98 JS	500260	17805010	250 FS	20985	15302178	301 FS						
518503	35405189	93 JS	965606	35409656	98 JS	856499	17803812	135 JS	20990	15300990	301 FS						
518603	35405186	93 JS	965712	35409657	98 JS				20994	15300221	301 FS						
519103	35400224	23 GS, 98 JS	965912	35400044	98 JS				21060	15301305	224 FS						
519203	35409203	98 JS	9659D2	35409659	98 JS				21076	15301624	300 FS						
519803	35400183	23 GS, 98 JS	967412	35409675	98 JS				21203	15306345	224 FS						
525006	35405006	102 JS	969112	35400219	23 GS, 97 JS				21204	15306360	224 FS						
526102	35405261	93 JS	975212	35409752	88 JS				21217	15306365	224 FS						
526202	35406202	92 JS	975504	35409755	88 JS				21225	15306315	7 GS, 224 FS						
526302	35405263	96 JS	975606	35409756	88 JS				21226	15306330	224 FS						
526502	35405266	22 GS, 93 JS	975712	35409758	88 JS				21227	15306410	224 FS						
536102	35405361	93 JS	975912	35400039	88 JS				21228	15306355	224 FS						
536202	35405362	93 JS							21229	15306395	224 FS						
539102	35400217	23 GS, 98 JS							21230	15306390	224 FS						
539202	35409202	98 JS							21232	15306325	224 FS						
539802	35405398	23 GS, 98 JS							21237	15306327	224 FS						
545604	35402003	98 JS							21238	15306323	224 FS						
549104	35400218	23 GS, 97 JS							21244	15301245	224 FS						
566502	35405665	22 GS, 93 JS							21247	15306333	224 FS						
571006	35405710	93 JS							21256	15306375	224 FS						
571506	35405715	22 GS, 93 JS							21257	15306370	224 FS						
572502	35405725	22 GS, 93 JS							22021	15306310	300 FS						
576204	35405762	92 JS							22025	15306320	300 FS						
579104	35400223	23 GS, 98 JS							22501	15304603	7 GS, 223 FS						
579804	35409804	23 GS, 98 JS							22502	15304610	7 GS, 223 FS						
628206	35406283	99 JS							22504	15304690	7 GS, 223 FS						
628506	35406285	99 JS							22505	15304670	7 GS, 223 FS						
629804	35406298	99 JS							22506	15304628	7 GS, 223 FS						
713410	35407134	96 JS							22507	15304644	7 GS, 223 FS						
718810	35408810	88 JS							22508	15304637	7 GS, 223 FS						
720001	35400021	102 JS							22509	15304640	7 GS, 223 FS						
720501	354000091	102 JS							22510	15304612	223 FS						
722004	35400017	88 JS							22601	15304605	223 FS						
723004	35400019	96 JS							22602	15304609	223 FS						
725504	35407255	94 JS							22603	15304625	223 FS						
726504	35400018	94 JS							22604	15304633	224 FS						
727204	35407204	95 JS							22605	15304632	7 GS, 224 FS						
729504	35400014	98 JS							22607	15304658	7 GS, 223 FS						
752002	35407520	88 JS							22608	15304615	223 FS						
753002	35403002	96 JS							22609	15304686	224 FS						
755602	35405602	94 JS							22610	15304629	224 FS						
756502	35400042	94 JS							22618	15304646	224 FS						
757202	35407202	95 JS							25774	15305774	224 FS						
759602	35407595	95 JS							25775	15305775	224 FS						
815012	35408150	100 JS							25776	15305776	224 FS						
850001	35408500	102 JS							25777	15305777	224 FS						
850201	35402101	102 JS							25778	15305778	224 FS						
856102	35408561	93 JS							60164	15300230	274 FS						
856202	35408562	92 JS							70310	15300278	274 FS						
856502	35408560	22 GS, 93 JS							70316	15300266	274 FS						
900512	35409005	102 JS							70416	15300281	274 FS						
901006	35401006	99 JS							71037	15301037	274 FS						
901112	35409011	99 JS							71091	15301091	274 FS						
901401	35409014	99 JS							71226	15300104	274 FS						
902210	35409022	99 JS							71840	15301840	274 FS						
903312	354090321	101 JS							71842	15301839	274 FS						
903412	35400027	101 JS							71843	15301838	274 FS						
903412	354000271	101 JS							71844	15301837	274 FS						
910212	35409102	90 JS							81206	15300310	226 FS						
910412	35409104	91 JS							81207	15301207	226 FS						
911212	35409113	91 JS		</													

Index	
2	Dyer Sheets
126	Dyer Carpet
128	Dyer Map Frames
76	Dyer Map Handouts
103	Dyer Map Mounts
102	Dyer Maps
116	Dyer Pins
2	Dyes
139	Dyeing Supplies
148	Dyeing Blush
E	
48, 101, 101	Electronic Calendar
101	Embossed Mailing
101, 101	Exam Gloves
102, 102	Extension File

Vendor Numeric Index

VENDOR NUMERIC INDEX

Mfg. #	Pg. #	Mfg. #	Pg. #	Mfg. #	Pg. #	Mfg. #	Pg. #	Mfg. #	Pg. #	Mfg. #	Pg. #			
01960	15401960	136 JS	21414	154014145	126 JS	93066	15403066	99 JS	B118	C6933012	14 GS, 273 FS			
01970	15401970	136 JS	21606	15400371	126 JS	95154	15405154	89 JS	B119	C6933013	14 GS, 273 FS			
01980	15401980	136 JS	25852	15405152	126 JS	95253	15405253	91 JS	CHW100	C6935001	9 GS, 257 FS			
01999	15401999	135 JS	26080	15406081	126 JS	96253	15400253	91 JS	CHW101	C6935004	9 GS, 257 FS			
02000	15402000	129 JS	28075	15408075	126 JS	98171	15408171	268 FS	CHW102	C6935007	9 GS, 257 FS			
02021	15400046	129 JS	30140	15400270	127 JS	98200	15408200	268 FS	CHW1200	C6935050	9 GS, 257 FS			
02031	15402031	26 GS, 129 JS	30210	15403021	127 JS	98380	15409838	268 FS	CHW200	C6935002	9 GS, 257 FS			
0204600	15404600	135 JS	33330	15403011	157 JS	98710	15409871	266 FS	CHW201	C6935005	9 GS, 257 FS			
02068	15402068	129 JS	33352	15407997	159 JS	98720	15408720	266 FS	CHW202	C6935008	9 GS, 257 FS			
02129	15402129	122 JS	33570	15407060	159 JS	98730	15408730	266 FS	CHW300	C6935003	9 GS, 257 FS			
02920	15402921	27 GS, 134 JS	34015	15404015	159 JS	98908	15409890	266 FS	CHW301	C6935006	9 GS, 257 FS			
0292050	15404140	134 JS	34133	15407946	157 JS	MARCAL PAPER MILLS								
03046	15404620	158 JS	34155	15407948	157 JS	0021	15700021	268 FS	G105	C6937003	31 GS, 199 JS			
0305100	15403051	129 JS	34256	15407952	157 JS	0028	15700028	265 FS	G106	C6937007	31 GS, 199 JS			
0307620	15407621	126 JS	34721	15407942	157 JS	16466	15706466	120 JS	GC16SR	C6930003	10 GS, 235 FS			
03131	15400038	127 JS	34790	15409050	159 JS	2930	15702930	127 JS	L001A	C6932000	8 GS, 225 FS			
03135	15403136	119 JS	34865	15406550	159 JS	3001	15703001	120 JS	L001B	C6932001	8 GS, 224 FS			
03148	15403148	122 JS	34955	15404955	159 JS	4034	15704034	127 JS	L003	C6932002	8 GS, 224 FS			
03405	15403405	132 JS	35010	15407981	145 JS	4036	15704036	127 JS	L003R	C6932003	8 GS, 224 FS			
03405	15403643	132 JS	35411	15401150	159 JS	4072	15704072	120 JS	L014A	C6932013	8 GS, 225 FS			
03607	15403607	120 JS	39109	15403609	132 JS	4074	15704074	120 JS	L014B	C6932014	8 GS, 224 FS			
03623	15403623	134 JS	41025	15401025	159 JS	L026A	C6932020	8 GS, 224 FS	L026B	C6932021	8 GS, 224 FS			
03650	15400026	136 JS	41026	15400346	159 JS	6079	15706080	120 JS	L027	C6932022	8 GS, 224 FS			
04007	15404007	120 JS	41041	15401041	159 JS	610	15700610	132 JS	L028	C6932023	8 GS, 225 FS			
04128	15404128	129 JS	41043	15401043	159 JS	6181	15706181	132 JS	L044	C6932038	8 GS, 224 FS			
04142	15404150	129 JS	41044	15401044	159 JS	6183	15700630	132 JS	L044R	C6932039	8 GS, 224 FS			
0446050	15406050	120 JS	41048	15401049	159 JS	630	15700630	132 JS	L12016	C6938036	14 GS, 287 FS			
05007	15405009	158 JS	41055	15404105	159 JS	6495	15700003	120 JS	L12025	C6938056	7 GS, 286 FS			
05027	15405027	158 JS	41100	15400366	159 JS	6506	15706507	266 FS	L14116	C6938037	14 GS, 287 FS			
05102	15405103	120 JS	41200	15400367	159 JS	6709	15706711	132 JS	L14128	C6938057	7 GS, 286 FS			
05120	15405120	160 JS	41200	15400425	159 JS	MENASHA PACKAGING								
05123	15405123	160 JS	41300	15404130	159 JS	GOL10	54210203	302 FS	L1783Z	C6938058	7 GS, 286 FS			
05320	15405320	157 JS	41455	15404145	159 JS	GOL12	54210211	302 FS	L628K	C6938075	14 GS, 245 FS			
05322	15405322	157 JS	41482	15401482	132 JS	GOL18	54210208	302 FS	L789K	C6938076	14 GS, 245 FS			
05514	15405515	158 JS	41600	15404160	159 JS	GOL8	54210208	302 FS	L959	C6938035	14 GS, 287 FS			
05701	15405711	158 JS	41702	15401702	159 JS	GOL9	54210210	302 FS	L988K	C6938012	10 GS, 235 FS			
05740	15405741	158 JS	47011	15400364	158 JS	GOLDWH	54210200	302 FS	P001	C6931000	8 GS, 224 FS			
05770	15405770	158 JS	47033	15407033	158 JS	GOLF	54210201	302 FS	P002	C6931001	8 GS, 225 FS			
05776	15405776	158 JS	48280	15400332	124 JS	GOLH	54210205	302 FS	P003	C6931002	8 GS, 225 FS			
05790	15405790	158 JS	50606	15400606	129 JS	GOLQ	54210204	302 FS	P005	C6931003	8 GS, 225 FS			
05796	15405796	158 JS	50606	15405060	129 JS	MILLENNIUM MAT								
05800	15405800	157 JS	54080	15400315	119 JS	14030500	C5440150	33 GS, 218 JS	P005R	C6931004	8 GS, 225 FS			
05812	15405812	157 JS	58310	15408310	100 JS	14040600	C5440151	33 GS, 218 JS	P007	C6931005	8 GS, 225 FS			
05816	15400355	157 JS	58399	15409960	158 JS	24020300	C5440300	33 GS, 219 JS	P007R	C6931006	8 GS, 225 FS			
05820	15400356	157 JS	592520	15402520	158 JS	24030500	C5440301	33 GS, 219 JS	P009	C6931008	8 GS, 225 FS			
05841	15405841	157 JS	64420	15406446	25 GS, 120 JS	EG020304	C5440200	33 GS, 219 JS	P011	C6931010	8 GS, 224 FS			
06053	15406053	159 JS	67223	15406722	25 GS, 122 JS	EG030504	C5440201	33 GS, 219 JS	P011R	C6931011	8 GS, 225 FS			
06211	15406212	161 JS	67805	15406780	25 GS, 122 JS	EG030508	C5440205	33 GS, 219 JS	P013	C6931012	8 GS, 225 FS			
06280	15406280	159 JS	75211	15405211	100 JS	EG031004	C5440202	33 GS, 219 JS	P013R	C6931013	8 GS, 225 FS			
07001	15407001	119 JS	75260	15405260	159 JS	EG031008	C5440206	33 GS, 219 JS	P020	C6931020	8 GS, 225 FS			
07005	15407005	122 JS	75935	15405935	100 JS	EG040604	C5440203	33 GS, 219 JS	P030	C6931030	8 GS, 225 FS			
07006	15407006	122 JS	83550	15403550	159 JS	EG040608	C5440207	33 GS, 219 JS	PLA98540	C6938003	10 GS, 235 FS			
07007	15407007	122 JS	83610	15403610	29 GS, 174 JS	NATIONAL CHECKING								
07202	15407202	123 JS	83620	15403620	29 GS, 174 JS	1015P	49200101	261 FS	PLA98650	C6938004	10 GS, 235 FS			
07223	15407224	122 JS	83630	15403630	29 GS, 174 JS	1300SP	49200037	261 FS	RC95250	C6938030	14 GS, 287 FS			
07304	15407305	122 JS	83980	15403980	29 GS, 174 JS	2300SP	49200041	262 FS	SB120300	C6938050	7 GS, 286 FS			
07410	15400379	144 JS	88125	15408125	132 JS	3516SP	49203516	261 FS	SB141500	C6938051	7 GS, 286 FS			
07713	15407713	119 JS	88130	15408130	135 JS	566	20250566	261 FS	SB1781000	C6938052	7 GS, 286 FS			
07805	15400373	122 JS	88336	15408336	119 JS	722580SP	49200047	262 FS	ST1025G12300W	C6935077	11 GS, 249 FS			
07827	15400374	123 JS	91057	15401057	99 JS	T225SP	49200044	262 FS	ST775N4500W	C6935078	11 GS, 249 FS			
08076	15408076	139 JS	91067	15401067	77 JS	7313SP	49200045	262 FS	T009	C6934006	16 GS, 300 FS			
09507	15409507	125 JS	91072	15400072	77 JS	926SW	20250021	261 FS	U120500	C6938001	14 GS, 287 FS			
09551	15400551	125 JS	91180	15401180	103 JS	G3616	49203616	260 FS	U1411000	C6938032	14 GS, 287 FS			
09765	15409765	139 JS	91182	15401086	103 JS	G3632	49201908	260 FS	NEWSPRING					
09989	15409989	141 JS	91211	15400055	91 JS	G3632SP	49201910	260 FS	E1002B	19519001	245 FS			
09990	15409990	139 JS	91220	15401220	91 JS	G4774SP	49201919	261 FS	E1003B	19519011	245 FS			
11090	15401091	129 JS	91241	15400047	91 JS	G6000	49201930	261 FS	E501	19510503	245 FS			
13135	15403137	119 JS	91298	15401298	89 JS	G7000	49201936	261 FS	E502	19510500	245 FS			
13607	15401360	120 JS	91300	15401300	91 JS	T4997SP	49205814	261 FS	E502B	19510502	245 FS			
13608	15400136	132 JS	91302	15400004	91 JS	T4997SP	49205816	261 FS	E503	19510510	245 FS			
17713	15407715	119 JS	91371	15401371	100 JS	NATURE FRIENDLY PRODUCTS								
21002	15401002	126 JS	91437	15401023	91 JS	AP6260	C6938070	14 GS, 245 FS	E503B	19510511	245 FS			
21005	15403036	126 JS	91547	15401547	89 JS	AP78105	C6938071	14 GS, 245 FS	E504	19510505	245 FS			
21195	15407610	126 JS	91554	15401554	93 JS	AP78130	C6938072	14 GS, 245 FS	E505B	19510520	245 FS			
21200	15400010	126 JS	91556	15401018	91 JS	B001	C6933001	14 GS, 273 FS	E506	19510526	245 FS			
21269	15406910	126 JS	91748	15400051	95 JS	B002	C6933002	14 GS, 273 FS	L2508	19512508	288 FS			
2127060	15407061	126 JS	91757	15401757	95 JS	B003	C6933003	14 GS, 273 FS	L2512	19512512	288 FS			
21271	15407619	126 JS	91923	15401923	91 JS	B020	C6933005	14 GS, 225 FS	L2516	19512516	288 FS			
21285	15401285	26 GS, 127 JS	91934	15401934	103 JS	B021	C6933006	14 GS, 224 FS	L2524	19512524	288 FS			
21295	15401295	26 GS, 127 JS	92053	15400054	91 JS	B024	C6933004	14 GS, 273 FS	L2532	19512532	288 FS			
21320	15401342	127 JS	92190	15402625	103 JS	B025	C6933007	14 GS, 273 FS	L5008	19515008	288 FS			
21340	15401340	127 JS	92519	15402519	86 JS	B110	C6933009	14 GS, 273 FS	L5012	19515012	288 FS			
21380	15405851	127 JS	93056	15403056	99 JS	B111	C6933010	14 GS, 273 FS	L5032	19515032	288 FS			
21390	15401390	127 JS	93060	15409306	99 JS	B112	C6933011	14 GS, 273 FS	L6064	19516064	288 FS			
21400	15407606	126 JS							L8328	19518328	288 FS			
												NC333B	19510333	282 FS

Vendor Numeric Index

Index	
2	Dye Sheets
100	Dye Cartridge
102	Dye Ink
104	Dye Ink Cartridge
106	Dye Ink Printer
108	Dye Ink Refill
110	Dye Ink Tank
112	Dye Ink Tank Printer
114	Dye Ink Tank Refill
116	Dye Ink Tank Printer Refill
118	Dye Ink Tank Printer Refill Kit
120	Dye Ink Tank Printer Refill Kit Refill
122	Dye Ink Tank Printer Refill Kit Refill Kit
124	Dye Ink Tank Printer Refill Kit Refill Kit Refill
126	Dye Ink Tank Printer Refill Kit Refill Kit Refill Kit
128	Dye Ink Tank Printer Refill Kit Refill Kit Refill Kit Refill
130	Dye Ink Tank Printer Refill Kit Refill Kit Refill Kit Refill Kit
132	Dye Ink Tank Printer Refill Kit Refill Kit Refill Kit Refill Kit Refill
134	Dye Ink Tank Printer Refill Kit Refill Kit Refill Kit Refill Kit Refill Kit
136	Dye Ink Tank Printer Refill Kit Refill Kit Refill Kit Refill Kit Refill Kit Refill
138	Dye Ink Tank Printer Refill Kit Refill Kit Refill Kit Refill Kit Refill Kit Refill Kit
140	Dye Ink Tank Printer Refill Kit Refill Kit Refill Kit Refill Kit Refill Kit Refill Kit Refill
142	Dye Ink Tank Printer Refill Kit Refill Kit Refill Kit Refill Kit Refill Kit Refill Kit Refill Kit
144	Dye Ink Tank Printer Refill Kit Refill Kit Refill Kit Refill Kit Refill Kit Refill Kit Refill Kit Refill
146	Dye Ink Tank Printer Refill Kit Refill Kit Refill Kit Refill Kit Refill Kit Refill Kit Refill Kit Refill Kit
148	Dye Ink Tank Printer Refill Kit Refill Kit Refill Kit Refill Kit Refill Kit Refill Kit Refill Kit Refill Kit Refill
150	Dye Ink Tank Printer Refill Kit Refill Kit Refill Kit Refill Kit Refill Kit Refill Kit Refill Kit Refill Kit Refill Kit

Mfg. #	#	Pg. #	Mfg. #	#	Pg. #	Mfg. #	#	Pg. #	Mfg. #	#	Pg. #	Mfg. #	#	Pg. #
634260	16208865	295 FS	CI83011	16201818	303 FS	CTSB100	16207590	245 FS	P92220	16209021	271 FS	TF3004H	16201287	329 FS
63735	16208824	294 FS	CI85024	16205024	285 FS	CTSB200PP00	16207588	245 FS	P92230	16209031	271 FS	TF3008H	16200437	329 FS
654835	16208870	294 FS	CI85032	16205030	285 FS	CTSB325	16207592	245 FS	P92505	16209704	298 FS	TF304D1	16200466	329 FS
66435	16208827	294 FS	CI85048	16205048	285 FS	CTSB400PP00	16207595	245 FS	P95105	16204684	284 FS	TF310S0	16201194	329 FS
664WP	16209108	294 FS	CI85064	16205064	285 FS	D28100	16201159	229 FS	P95108	16204690	284 FS	TF325SH	16201231	329 FS
6708WPSFG	16206708	293 FS	CI85100	16205076	285 FS	EH89045	16208945	305 FS	P95109	16202218	284 FS	TF902S0	16200663	329 FS
69030DR	16208830	293 FS	CI85101	16205101	285 FS	EH89148	16201732	279 FS	P9812	16206905	272 FS	TF410S0	16201195	329 FS
6951130	16208835	294 FS	CI85200	16205200	285 FS	EH89160	16200415	279 FS	P9816	16206906	272 FS	TF90020	16200428	329 FS
702145	16208829	294 FS	CI85201	16205202	285 FS	EH89170	16200416	279 FS	P9818	16206904	272 FS	TF902P	16200807	329 FS
70530	16202372	294 FS	CI85300	16205080	285 FS	EH89170	16201708	279 FS	PBA7106	16200560	16 GS, 275 FS	TF902S0	16201409	329 FS
70530	16209127	294 FS	CI85301	16205077	285 FS	EH89190	16200621	279 FS	PBC5613R	16202614	16 GS, 275 FS	TF904D1	16200470	329 FS
70845	16209125	294 FS	CI85430	16205430	285 FS	EH89190	16201711	279 FS	PBC5615	16202615	16 GS, 275 FS	TF904S0	16200483	329 FS
7139TP	16209119	294 FS	CI85611R	16200646	16 GS, 275 FS	EH89193	16200631	279 FS	PBC6816	16200236	16 GS, 275 FS	TF908PH	16200926	329 FS
74730	16200747	294 FS	CI85613	16201118	16 GS, 275 FS	EH89193	16201712	279 FS	PBC7014	16200625	16 GS, 275 FS	TF910S0	16200042	329 FS
78830	16202145	294 FS	CI85613R	16200012	16 GS, 275 FS	EH89701	16200701	303 FS	PCS01305	16201056	16 GS, 298 FS	TF912S0	16200669	329 FS
78830	16209135	294 FS	CI85615	16200606	16 GS, 275 FS	EH89801	16201847	303 FS	PCS01505	16201055	16 GS, 298 FS	TF916S0	16201208	329 FS
788TP	16209136	294 FS	CI85710	16201125	16 GS, 275 FS	EH89802	16201848	303 FS	PCS0412	16200856	16 GS, 275 FS	TF925SH	16201573	329 FS
79945	16208805	294 FS	CI85713	16200848	16 GS, 275 FS	HD1P8L1	16201228	291 FS	PCS0511	16202540	16 GS, 275 FS	TFB0020	16200427	329 FS
80215	16201248	291 FS	CI85713R	16205712	17 GS, 275 FS	HD3P8L1	16201229	291 FS	PCS0713H	16201054	16 GS, 275 FS	TFB009H	16200884	329 FS
80215	16201439	291 FS	CI86008	16206008	285 FS	HLW0184	16201323	292 FS	PCS4403	16204403	16 GS, 275 FS	TFB01S0	16207050	329 FS
80581	16201458	291 FS	CI86012	16200574	285 FS	HLW0188	16201306	292 FS	PCS4412	16201106	16 GS, 275 FS	TFB02S0	16200540	329 FS
80583	16201449	291 FS	CI86016	16200575	285 FS	HLW0189	16201338	292 FS	PCS4413	16201053	16 GS, 275 FS	TFB04D1	16200623	329 FS
80663	16201453	291 FS	CI86024	16201830	285 FS	HLW0600	16201533	292 FS	PCS4512	16200865	16 GS, 275 FS	TFB04S0	16200487	329 FS
85910	16205910	230 FS	CI86024	16206024	285 FS	HLW0701	16201381	292 FS	PCS4707	16202541	16 GS, 275 FS	TFB10S0	16200670	329 FS
85914	16205914	230 FS	CI86032	16206032	285 FS	HLW0703	16201143	292 FS	PCS5611R	16208501	16 GS, 275 FS	TH10004	16200141	228 FS
8X1172P	64930203	285 FS	CI86064	16206064	285 FS	HLW0703	16201382	292 FS	PCS5613	16201119	16 GS, 275 FS	TH10006	16200031	228 FS
8X11PL	64930204	285 FS	CI86816	16208839	17 GS, 275 FS	HLW0801	16201383	292 FS	PCS5613RR1	16208503	16 GS, 275 FS	TH10007	16200030	228 FS
9005X	16209005	271 FS	CI88062	16200282	284 FS	HLW0803	16200951	292 FS	PCS5615	16208502	16 GS, 275 FS	TH10009	16200032	228 FS
9006K	16209006	271 FS	CI881116	16200648	17 GS, 275 FS	HLW0803	16201386	292 FS	PCS5617	16202542	16 GS, 275 FS	TH10009	16200071	228 FS
9007K	16209007	271 FS	CI89019	16209019	305 FS	HLW0901	16201390	292 FS	PCS5710	16201123	16 GS, 275 FS	TH10010	16200136	228 FS
9146	16209818	305 FS	CI89060	16200788	305 FS	HLW0903	16201318	292 FS	PCS5713	16205714	16 GS, 275 FS	TH10011	16200127	228 FS
92032	16209197	286 FS	CI89360	16202068	305 FS	HLW0903	16201393	292 FS	PCS5713R	16202023	16 GS, 275 FS	TH10012	16200159	228 FS
92032SCH	16209196	286 FS	CI89446	16209446	305 FS	HLW1001	16201319	292 FS	PCS5811R	16207342	16 GS, 275 FS	TH10022	16200177	228 FS
92220K	16209020	271 FS	CI89801	16201839	303 FS	HLW1001	16201640	292 FS	PCS6812R	16207341	17 GS, 275 FS	TH10030	16200166	228 FS
92230K	16209030	271 FS	CI89802	16209802	303 FS	HLW1003	16201321	292 FS	PCS6815	16201645	17 GS, 275 FS	TH10034	16200265	301 FS
9510SKH	16200261	303 FS	CI89901	16209901	303 FS	HLW1003	16201646	292 FS	PCS6816	16201057	17 GS, 275 FS	TH10043	16200167	228 FS
9519SK	16201857	303 FS	CI8D714	16200636	17 GS, 275 FS	HLWV901	16201536	292 FS	PCS7014	16204646	17 GS, 275 FS	TH10044	16200138	228 FS
95240W	16204695	284 FS	CN80600	16201421	15 GS, 280 FS	HLWV903	16201534	292 FS	PCS81116	16200251	17 GS, 275 FS	TH10045	16201253	228 FS
95940K	16209881	284 FS	CN80801	16201413	15 GS, 280 FS	HSSB500R	16205971	303 FS	PCTS5100	16200678	245 FS	TH10061	16200035	291 FS
95970K	16202216	284 FS	CN80803	16201411	15 GS, 280 FS	HTF11014	16201407	328 FS	PCTS5325	16200661	245 FS	TH10063	16201648	291 FS
95970K	16209882	284 FS	CN80901	16201405	15 GS, 280 FS	HTF91014	16201170	328 FS	PCTS5B50	16205000	245 FS	TH10079	16201542	291 FS
95980K	16202217	284 FS	CN80903	16201404	15 GS, 280 FS	JCTS2B200000	16202420	245 FS	PEP4512	16200852	17 GS, 275 FS	TH10080	16201554	291 FS
966512KWP	16206502	271 FS	CN8460H	16200468	283 FS	JCTS3B400000	16202421	245 FS	PEP5613R	16200600	17 GS, 275 FS	TH10081	16201544	291 FS
9710H	16209770	305 FS	CN84612	16200608	283 FS	L509	16206545	293 FS	PEP5615	16201504	17 GS, 275 FS	TH10089	16202314	291 FS
9710H	16200005	305 FS	CN84616	16200290	283 FS	L527	16206445	293 FS	PEP5713R	16200599	17 GS, 275 FS	TH10098	16200186	291 FS
9714SKH	16209717	303 FS	CN84624	16200610	283 FS	L7021	16207021	294 FS	PEP6815	16209122	17 GS, 275 FS	TH10098	16202311	291 FS
9714SKS	16209774	303 FS	CN8462H	16201173	283 FS	L705	16200225	294 FS	PEP6816	16201503	17 GS, 275 FS	TH10099	16200694	291 FS
9719SKH	16209892	303 FS	CN84632	16209463	283 FS	L788	16203400	294 FS	PEP7014	16209121	17 GS, 275 FS	TH10205	16200269	291 FS
976	16209747	279 FS	CN84636	16201322	283 FS	LRW64	16200364	286 FS	PESS0	64931600	304 FS	TH10206	16200913	291 FS
9812K	16209812	272 FS	CN84637	16200292	283 FS	LSL3	16202448	245 FS	PHS50S	64930049	304 FS	TH10500	16200304	301 FS
9812KWP	16209813	272 FS	CN84638	16204638	283 FS	LSL5	16202449	245 FS	PLSL1	16201962	245 FS	TH10601	16200306	301 FS
9816K	16206913	272 FS	CN8466H	16200431	283 FS	M336126	16200313	298 FS	PLSL2	16201963	245 FS	TH50004	16200094	228 FS
9818K	16206914	272 FS	CN8467H	16200457	283 FS	M336184	16200314	298 FS	PQS425S	64930426	304 FS	TH50006	16200199	228 FS
9818KWP	16206916	272 FS	CN8468H	16200456	283 FS	M510032	16203521	302 FS	PQS50SLP	64930556	304 FS	TIBH009	16200867	227 FS
9912K	16206912	272 FS	CN85008	16205302	284 FS	M513504	16200165	301 FS	PSPO615PUNPC	16202516	8 GS, 222 FS	TIBH044	16200883	227 FS
CA91008	16201013	279 FS	CN85012	16209826	284 FS	M527535	16200175	302 FS	PSPO605PUNPCF	16202515	8 GS, 222 FS	TK10004	16200307	229 FS
CA91012	16201012	279 FS	CN85016	16200274	284 FS	M527543	16200170	302 FS	PSPO705PUNPC	16202514	8 GS, 222 FS	TK10006	16200189	229 FS
CA91016	16201016	279 FS	CN85024	16202903	284 FS	MC50006	16206879	8 GS, 225 FS	PSPO905PUNPC	16202513	8 GS, 222 FS	TK10007	16200200	229 FS
CA91024	16201024	279 FS	CN85024	16205034	284 FS	MC5000600001	16206897							

2	Dyer Sheets	156
126	Dyer Carpet	156
127	Dyer Map Frames	156
128	Dyer Map Handies	156
129	Dyer Map Mounts	156
130	Dyer Maps	156
131	Dyer Pins	156
132	Dyers	156
133	Dyers Supplies	156
134	Dyeing Slush	156
135		156
136		156
137		156
138		156
139		156
140		156
141		156
142		156
143		156
144		156
145		156
146		156
147		156
148		156
149		156
150		156
151		156
152		156
153		156
154		156
155		156

Vendor Numeric Index

VENDOR NUMERIC INDEX

Mfg. #	#	Pg. #	Mfg. #	#	Pg. #	Mfg. #	#	Pg. #	Mfg. #	#	Pg. #	Mfg. #	#	Pg. #	Mfg. #	#	Pg. #
TXB0043	16201345	230 FS	73004390	73004390	12 GS, 267 FS	75000114	75000114	259 FS	75001302	75001302	316 FS	75002301	75002301	251 FS	75002301	75002301	251 FS
TXB0044	16200741	230 FS	73004391	73004391	12 GS, 267 FS	75000200	75000200	330 FS	75001310	75001310	316 FS	75002304	75002304	251 FS	75002304	75002304	251 FS
TXB0047	16201335	230 FS	73004392	73004392	12 GS, 267 FS	75000202	75000202	330 FS	75001311	75001311	316 FS	75002305	75002305	251 FS	75002305	75002305	251 FS
TXB044D	16209735	230 FS	73004393	73004393	12 GS, 267 FS	75000202	75000202	330 FS	75001312	75001312	316 FS	75002310	75002310	251 FS	75002310	75002310	251 FS
TXB0600	16201548	291 FS	73004394	73004394	12 GS, 267 FS	75000203	75000203	330 FS	75001313	75001313	316 FS	75002311	75002311	251 FS	75002311	75002311	251 FS
TXB0901	16201429	291 FS	73004395	73004395	267 FS	75000203	75000203	330 FS	75001341	75001341	316 FS	75002313	75002313	251 FS	75002313	75002313	251 FS
W12	16206500	325 FS	73004397	73004397	267 FS	75000204	75000204	330 FS	75001750	75001750	317 FS	75002314	75002314	251 FS	75002314	75002314	251 FS
W17	16206504	325 FS	73004400	73004400	126 JS	75000206	75000206	330 FS	75001765	75001765	195 JS	75002340	75002340	248 FS	75002340	75002340	248 FS
W18	16206505	325 FS	73005160	73005160	150 JS, 333 FS	75000206	75000206	330 FS	75001776	75001776	315 FS	75002360	75002360	248 FS	75002360	75002360	248 FS
W23	16206510	325 FS	73005170	73005170	150 JS, 333 FS	75000208	75000208	330 FS	75001777	75001777	315 FS	75002361	75002361	248 FS	75002361	75002361	248 FS
W25	16206515	325 FS	73005180	73005180	150 JS, 333 FS	75000209	75000209	330 FS	75001778	75001778	315 FS	75002365	75002365	248 FS	75002365	75002365	248 FS
W26	16206520	325 FS	73005190	73005190	150 JS, 333 FS	75000209	75000209	330 FS	75001779	75001779	315 FS	75002369	75002369	248 FS	75002369	75002369	248 FS
W28	16206525	325 FS	73005260	73005260	150 JS, 333 FS	75000221	75000221	330 FS	75001780	75001780	315 FS	75002370	75002370	248 FS	75002370	75002370	248 FS
W35	16202450	325 FS	73005270	73005270	150 JS, 333 FS	75000225	75000225	330 FS	75001781	75001781	315 FS	75002371	75002371	248 FS	75002371	75002371	248 FS
W38	16206590	325 FS	73005280	73005280	150 JS, 333 FS	75000255	75000255	262 FS	75001782	75001782	315 FS	75002372	75002372	248 FS	75002372	75002372	248 FS
W65	16206540	324 FS	73005290	73005290	150 JS, 333 FS	75000255	75000255	262 FS	75001783	75001783	315 FS	75002373	75002373	248 FS	75002373	75002373	248 FS
W69	16201326	324 FS	73006300	73006300	193 JS	75000950	75000950	324 FS	75001810	75001810	325 FS	75002375	75002375	248 FS	75002375	75002375	248 FS
W70	16201320	324 FS	73006304	73006304	193 JS	75001002	75001002	195 JS	75001829	75001829	312 FS	75002376	75002376	248 FS	75002376	75002376	248 FS
W71	16201310	324 FS	73006310	73006310	193 JS	75001004	75001004	195 JS	75001830	75001830	312 FS	75002377	75002377	248 FS	75002377	75002377	248 FS
W72	16206560	324 FS	73006314	73006314	193 JS	75001005	75001005	195 JS	75001838	75001838	312 FS	75002378	75002378	248 FS	75002378	75002378	248 FS
W72BCH	16206565	324 FS	73006322	73006322	193 JS	75001007	75001007	195 JS	75001844	75001844	316 FS	75002379	75002379	248 FS	75002379	75002379	248 FS
W72GCH	16206570	324 FS	73006332	73006332	193 JS	75001008	75001008	195 JS	75001846	75001846	316 FS	75002381	75002381	248 FS	75002381	75002381	248 FS
W72RCH	16206575	324 FS	73006334	73006334	193 JS	75001012	75001012	195 JS	75001847	75001847	316 FS	75002382	75002382	248 FS	75002382	75002382	248 FS
W73	16206580	324 FS	73006338	73006338	193 JS	75001013	75001013	195 JS	75001849	75001849	316 FS	75002384	75002384	248 FS	75002384	75002384	248 FS
WC12	16206497	325 FS	73006340	73006340	193 JS	75001014	75001014	195 JS	75001850	75001850	325 FS	75002387	75002387	248 FS	75002387	75002387	248 FS
WC17	16206499	325 FS	73006344	73006344	193 JS	75001015	75001015	195 JS	75001854	75001854	312 FS	75002388	75002388	248 FS	75002388	75002388	248 FS
WC18	16206498	325 FS	73006356	73006356	193 JS	75001019	75001019	195 JS	75001855	75001855	312 FS	75002389	75002389	248 FS	75002389	75002389	248 FS
YB0661	16201451	291 FS	73006358	73006358	193 JS	75001021	75001021	195 JS	75002001	75002001	231 FS	75002391	75002391	248 FS	75002391	75002391	248 FS
YE160	16201569	235 FS	73006360	73006360	193 JS	75001023	75001023	195 JS	75002004	75002004	231 FS	75002393	75002393	248 FS	75002393	75002393	248 FS
YHCL16ENV	16205600	233 FS	73006362	73006362	193 JS	75001025	75001025	195 JS	75002005	75002005	231 FS	75002394	75002394	248 FS	75002394	75002394	248 FS
YHCL20ENV	16205602	233 FS	73006363	73006363	193 JS	75001027	75001027	195 JS	75002006	75002006	231 FS	75002400	75002400	252 FS	75002400	75002400	252 FS
YHCL24ENV	16205601	233 FS	73006364	73006364	193 JS	75001028	75001028	195 JS	75002007	75002007	231 FS	75002402	75002402	248 FS	75002402	75002402	248 FS
YLPADL24C	16202476	11 GS, 235 FS	73006368	73006368	195 JS	75001029	75001029	195 JS	75002008	75002008	231 FS	75002407	75002407	248 FS	75002407	75002407	248 FS
YPLA24C	16202042	11 GS, 235 FS	73006369	73006369	195 JS	75001030	75001030	195 JS	75002010	75002010	325 FS	75002413	75002413	248 FS	75002413	75002413	248 FS
YLSPLA2	16202564	15 GS	73006370	73006370	195 JS	75001032	75001032	195 JS	75002011	75002011	325 FS	75002414	75002414	248 FS	75002414	75002414	248 FS
YLSPLA3	16202563	15 GS	73006371	73006371	195 JS	75001033	75001033	195 JS	75002023	75002023	231 FS	75002420	75002420	248 FS	75002420	75002420	248 FS
YMC500110001	16201577	8 GS, 225 FS	73006372	73006372	194 JS	75001035	75001035	195 JS	75002024	75002024	231 FS	75002425	75002425	248 FS	75002425	75002425	248 FS
YPLA1412C	16202474	11 GS, 235 FS	73006373	73006373	194 JS	75001036	75001036	195 JS	75002025	75002025	231 FS	75002440	75002440	287 FS	75002440	75002440	287 FS
YPLA160C	16202473	11 GS, 235 FS	73006374	73006374	194 JS	75001037	75001037	195 JS	75002028	75002028	231 FS	75002441	75002441	287 FS	75002441	75002441	287 FS
YPLA21C	16202472	11 GS, 235 FS	73006375	73006375	194 JS	75001038	75001038	195 JS	75002031	75002031	231 FS	75002442	75002442	287 FS	75002442	75002442	287 FS
YPLA24C	16202469	11 GS, 235 FS	73006376	73006376	194 JS	75001043	75001043	195 JS	75002040	75002040	232 FS	75002443	75002443	287 FS	75002443	75002443	287 FS
YPLA9C	16202475	11 GS, 235 FS	73006377	73006377	194 JS	75001048	75001048	195 JS	75002041	75002041	232 FS	75002444	75002444	287 FS	75002444	75002444	287 FS
YSPLA200EC	16202561	15 GS, 245 FS	73006378	73006378	194 JS	75001074	75001074	195 JS	75002042	75002042	232 FS	75002445	75002445	287 FS	75002445	75002445	287 FS
YSPLA300EC	16202562	15 GS, 245 FS	73006379	73006379	194 JS	75001083	75001083	195 JS	75002043	75002043	232 FS	75002446	75002446	287 FS	75002446	75002446	287 FS
YSPLA400EC	16202565	15 GS, 245 FS	73007122	73007122	148 JS, 331 FS	75001088	75001088	195 JS	75002044	75002044	232 FS	75002447	75002447	287 FS	75002447	75002447	287 FS
YTXB00900000	16201649	230 FS	73007132	73007132	148 JS, 331 FS	75001090	75001090	195 JS	75002050	75002050	325 FS	75002449	75002449	287 FS	75002449	75002449	287 FS
YU80661CSUPC	16201506	291 FS	73007142	73007142	148 JS, 331 FS	75001094	75001094	195 JS	75002051	75002051	232 FS	75002450	75002450	287 FS	75002450	75002450	287 FS
			73007152	73007152	148 JS, 331 FS	75001095	75001095	195 JS	75002056	75002056	232 FS	75002451	75002451	287 FS	75002451	75002451	287 FS
			73007500	73007500	248 FS	75001124	75001124	195 JS	75002057	75002057	232 FS	75002452	75002452	287 FS	75002452	75002452	287 FS
			73008000	73008000	326 FS	75001155	75001155	195 JS	75002083	75002083	273 FS	75002453	75002453	287 FS	75002453	75002453	287 FS
			73008001	73008001	326 FS	75001166	75001166	195 JS	75002085	75002085	273 FS	75002454	75002454	287 FS	75002454	75002454	287 FS
			73009121	73009121	324 FS	75001169	75001169	195 JS	75002087	75002087	273 FS	75002456	75002456	287 FS	75002456	75002456	287 FS
			75000023	75000023	316 FS	75001173	75001173	195 JS	75002089	75002089	273 FS	75002457	75002457	287 FS	75002457		

Index	
2	Dyer Sheets
126	Dyer Carpet
128	Dyer Map Frames
76	Dyer Map Handies
53	Dyer Map Mounts
102	Dyer Maps
7	Dyer Pins
116	Dyers
2	Dyers
129	Dyeing Blush
148	Dyeing
150	Dyeing
48, 150, 151	Electronic Calculator
101	Embossed Mailings
101, 101	Exam Gloves
102, 102	Extension File

Vendor Numeric Index

VENDOR NUMERIC INDEX

Mfg. #	Pg. #	Mfg. #	Pg. #	Mfg. #	Pg. #	Mfg. #	Pg. #	Mfg. #	Pg. #
75004246	92 JS	75004387	265 FS	75004474	216 JS	75004689	181 JS	75004764	175 JS
75004247	92 JS	75004388	267 FS	75004475	215 JS	75004690	181 JS	75004765	175 JS
75004248	101 JS	75004389	267 FS	75004476	108 JS	75004691	181 JS	75004766	175 JS
75004249	101 JS	75004390	267 FS	75004477	108 JS	75004692	181 JS	75004766	175 JS
75004250	100 JS	75004391	216 JS	75004478	108 JS	75004693	181 JS	75004767	175 JS
75004253	92 JS	75004392	215 JS	75004479	215 JS	75004694	181 JS	75004769	175 JS
75004254	101 JS	75004393	215 JS	75004480	111 JS	75004695	183 JS	75004770	175 JS
75004254	101 JS	75004394	216 JS	75004481	111 JS	75004695	183 JS	75004770	175 JS
75004255	100 JS	75004395	215 JS	75004482	111 JS	75004696	183 JS	75004771	175 JS
75004256	92 JS	75004397	215 JS	75004483	111 JS	75004696	183 JS	75004771	175 JS
75004259	101 JS	75004398	215 JS	75004484	111 JS	75004697	183 JS	75004772	175 JS
75004259	101 JS	75004399	216 JS	75004487	110 JS	75004697	183 JS	75004772	175 JS
75004260	22 GS, 92 JS	75004401	216 JS	75004488	110 JS	75004698	183 JS	75004773	175 JS
75004261	22 GS, 92 JS	75004403	215 JS	75004490	111 JS	75004698	183 JS	75004775	175 JS
75004262	22 GS, 92 JS	75004404	215 JS	75004491	216 JS	75004699	183 JS	75004777	167 JS
75004290	165 JS	75004405	216 JS	75004493	107 JS	75004699	183 JS	75004778	176 JS
75004290	165 JS	75004406	216 JS	75004495	215 JS	75004700	183 JS	75004779	176 JS
75004291	165 JS	75004407	216 JS	75004496	111 JS	75004700	183 JS	75004779	176 JS
75004291	165 JS	75004408	215 JS	75004501	110 JS	75004702	181 JS	75004780	176 JS
75004292	165 JS	75004409	215 JS	75004502	110 JS	75004703	181 JS	75004780	176 JS
75004301	137 JS	75004410	215 JS	75004504	108 JS	75004704	181 JS	75004781	176 JS
75004301	137 JS	75004411	215 JS	75004505	108 JS	75004706	181 JS	75004781	176 JS
75004301	137 JS	75004412	215 JS	75004506	108 JS	75004707	181 JS	75004782	176 JS
75004302	137 JS	75004413	215 JS	75004507	110 JS	75004708	181 JS	75004782	176 JS
75004302	137 JS	75004414	215 JS	75004508	110 JS	75004709	181 JS	75004783	176 JS
75004303	267 FS	75004415	215 JS	75004510	107 JS	75004709	181 JS	75004783	176 JS
75004304	133 JS	75004416	215 JS	75004510	107 JS	75004710	181 JS	75004784	176 JS
75004304	133 JS	75004417	215 JS	75004511	46 JS	75004713	182 JS	75004785	176 JS
75004306	135 JS	75004418	215 JS	75004511	46 JS	75004715	167 JS	75004785	176 JS
75004306	135 JS	75004419	215 JS	75004580	42 JS	75004715	167 JS	75004785	176 JS
75004307	135 JS	75004421	216 JS	75004581	42 JS	75004716	182 JS	75004786	217 JS
75004307	135 JS	75004421	216 JS	75004582	52 JS	75004716	182 JS	75004786	217 JS
75004307	135 JS	75004422	216 JS	75004583	52 JS	75004716	182 JS	75004787	217 JS
75004312	133 JS	75004423	215 JS	75004584	53 JS	75004717	182 JS	75004787	217 JS
75004315	128 JS	75004424	215 JS	75004585	53 JS	75004717	182 JS	75004788	217 JS
75004321	128 JS	75004425	215 JS	75004586	57 JS	75004718	182 JS	75004789	217 JS
75004321	128 JS	75004426	215 JS	75004587	57 JS	75004718	182 JS	75004790	217 JS
75004322	128 JS	75004427	216 JS	75004588	70 JS	75004719	182 JS	75004791	181 JS
75004322	128 JS	75004428	215 JS	75004588	70 JS	75004719	182 JS	75004791	181 JS
75004322	128 JS	75004429	216 JS	75004630	175 JS	75004719	182 JS	75004793	181 JS
75004323	128 JS	75004429	216 JS	75004631	175 JS	75004720	179 JS	75004797	181 JS
75004324	128 JS	75004430	216 JS	75004632	175 JS	75004721	179 JS	75004806	193 JS
75004324	128 JS	75004431	216 JS	75004632	175 JS	75004721	179 JS	75004806	193 JS
75004324	128 JS	75004432	215 JS	75004633	175 JS	75004722	179 JS	75004807	194 JS
75004326	128 JS	75004433	215 JS	75004634	183 JS	75004723	179 JS	75004811	193 JS
75004327	132 JS	75004433	215 JS	75004642	183 JS	75004724	179 JS	75004813	193 JS
75004327	132 JS	75004434	215 JS	75004643	183 JS	75004724	179 JS	75004813	193 JS
75004328	132 JS	75004435	215 JS	75004644	183 JS	75004725	179 JS	75004814	193 JS
75004328	132 JS	75004435	215 JS	75004648	181 JS	75004725	179 JS	75004820	193 JS
75004332	128 JS	75004436	216 JS	75004648	181 JS	75004725	182 JS	75004820	193 JS
75004333	128 JS	75004437	215 JS	75004649	181 JS	75004726	182 JS	75004827	195 JS
75004333	128 JS	75004437	215 JS	75004651	180 JS	75004726	182 JS	75004828	193 JS
75004334	128 JS	75004438	215 JS	75004651	180 JS	75004727	182 JS	75004855	193 JS
75004335	138 JS	75004439	216 JS	75004651	180 JS	75004727	182 JS	75004855	193 JS
75004335	138 JS	75004439	216 JS	75004652	180 JS	75004728	179 JS	75004856	193 JS
75004336	138 JS	75004440	215 JS	75004652	180 JS	75004729	179 JS	75004857	193 JS
75004337	124 JS	75004441	215 JS	75004653	180 JS	75004731	179 JS	75004858	193 JS
75004337	124 JS	75004442	215 JS	75004653	180 JS	75004731	179 JS	75004858	193 JS
75004337	124 JS	75004442	215 JS	75004653	180 JS	75004731	179 JS	75004860	193 JS
75004339	138 JS	75004443	215 JS	75004653	180 JS	75004732	179 JS	75004861	193 JS
75004340	124 JS	75004444	216 JS	75004653	180 JS	75004732	179 JS	75004862	193 JS
75004340	124 JS	75004445	215 JS	75004655	180 JS	75004733	179 JS	75004862	193 JS
75004341	138 JS	75004446	215 JS	75004655	180 JS	75004734	179 JS	75004863	193 JS
75004341	138 JS	75004446	215 JS	75004656	180 JS	75004734	179 JS	75004863	193 JS
75004342	126 JS	75004447	216 JS	75004661	180 JS	75004734	179 JS	75004865	193 JS
75004343	124 JS	75004448	216 JS	75004661	180 JS	75004735	179 JS	75004866	193 JS
75004343	124 JS	75004448	216 JS	75004662	180 JS	75004735	179 JS	75004866	193 JS
75004344	124 JS	75004449	215 JS	75004663	180 JS	75004736	179 JS	75004867	193 JS
75004345	138 JS	75004450	215 JS	75004663	180 JS	75004736	179 JS	75004869	193 JS
75004346	124 JS	75004451	215 JS	75004663	180 JS	75004737	179 JS	75004872	193 JS
75004346	124 JS	75004451	215 JS	75004663	180 JS	75004737	179 JS	75004873	193 JS
75004348	138 JS	75004452	215 JS	75004663	180 JS	75004738	179 JS	75004873	193 JS
75004348	138 JS	75004452	215 JS	75004665	180 JS	75004738	179 JS	75004874	193 JS
75004351	123 JS	75004453	216 JS	75004665	180 JS	75004738	179 JS	75004874	193 JS
75004351	123 JS	75004453	216 JS	75004665	180 JS	75004739	179 JS	75004876	193 JS
75004352	123 JS	75004454	215 JS	75004665	180 JS	75004743	182 JS	75004880	193 JS
75004353	119 JS	75004455	216 JS	75004667	179 JS	75004743	182 JS	75004880	193 JS
75004354	119 JS	75004456	216 JS	75004667	179 JS	75004744	182 JS	75004881	193 JS
75004354	119 JS	75004456	216 JS	75004668	179 JS	75004744	182 JS	75004882	193 JS
75004355	119 JS	75004457	215 JS	75004668	179 JS	75004745	182 JS	75004882	193 JS
75004355	119 JS	75004457	215 JS	75004668	179 JS	75004745	182 JS	75004884	193 JS
75004355	119 JS	75004458	215 JS	75004669	179 JS	75004745	182 JS	75004885	193 JS
75004355	119 JS	75004458	215 JS	75004669	179 JS	75004745	182 JS	75004885	193 JS
75004356	124 JS	75004459	215 JS	75004669	179 JS	75004746	182 JS	75004888	193 JS
75004357	124 JS	75004460	215 JS	75004671	181 JS	75004746	182 JS	75004888	193 JS
75004358	123 JS	75004461	216 JS	75004671	181 JS	75004746	182 JS	75004889	193 JS
75004358	123 JS	75004461	216 JS	75004672	181 JS	75004747	182 JS	75004890	193 JS
75004358	123 JS	75004462	216 JS	75004673	181 JS	75004747	182 JS	75004890	193 JS
75004359	123 JS	75004463	216 JS	75004673	181 JS	75004749	182 JS	75004901	168 JS
75004360	119 JS	75004464	216 JS	75004673	181 JS	75004749	182 JS	75004901	168 JS
75004360	119 JS	75004464	216 JS	75004673	181 JS	75004749	182 JS	75004901	168 JS
75004361	123 JS	75004465	215 JS	75004673	181 JS	75004752	187 JS	75004902	168 JS
75004361	123 JS	75004465	215 JS	75004674	179 JS	75004756	179 JS	75004902	168 JS
75004370	144 JS	75004466	215 JS	75004675	181 JS	75004756	179 JS	75004903	168 JS
75004372	144 JS	75004467	164 JS	75004675	181 JS	75004756	179 JS	75004903	168 JS
75004378	138 JS	75004467	164 JS	75004681	181 JS	75004757	167 JS	75004903	168 JS
75004378	138 JS	75004467	164 JS	75004682	181 JS	75004758	183 JS	75004904	168 JS
75004379	265 FS	75004468	165 JS	75004682	181 JS	75004758	183 JS	75004904	168 JS
75004380	265 FS	75004468	165 JS	75004683	181 JS	75004759	183 JS	75004905	168 JS
75004380	265 FS	75004468	165 JS	75004683	181 JS	75004759	183 JS	75004905	168 JS
75004381	265 FS	75004469	216 JS	75004683	181 JS	75004760	175 JS	75004905	168 JS
75004381	265 FS	75004469	216 JS	75004685	181 JS	75004761	175 JS	75004906	168 JS
75004383	265								

Vendor Numeric Index

Index	
2	Dryer Sheets
100	Dryer Cargos
102	Dryer Mats
104	Dryer Mats
106	Dryer Mats
108	Dryer Mats
110	Dryer Mats
112	Dryer Mats
114	Dryer Mats
116	Dryer Mats
118	Dryer Mats
120	Dryer Mats
122	Dryer Mats
124	Dryer Mats
126	Dryer Mats
128	Dryer Mats
130	Dryer Mats
132	Dryer Mats
134	Dryer Mats
136	Dryer Mats
138	Dryer Mats
140	Dryer Mats
142	Dryer Mats
144	Dryer Mats
146	Dryer Mats
148	Dryer Mats
150	Dryer Mats
152	Dryer Mats
154	Dryer Mats
156	Dryer Mats
158	Dryer Mats
160	Dryer Mats
162	Dryer Mats
164	Dryer Mats
166	Dryer Mats
168	Dryer Mats
170	Dryer Mats
172	Dryer Mats
174	Dryer Mats
176	Dryer Mats
178	Dryer Mats
180	Dryer Mats
182	Dryer Mats
184	Dryer Mats
186	Dryer Mats
188	Dryer Mats
190	Dryer Mats
192	Dryer Mats
194	Dryer Mats
196	Dryer Mats
198	Dryer Mats
200	Dryer Mats

Mfg. #	#	Pg. #	Mfg. #	#	Pg. #	Mfg. #	#	Pg. #	Mfg. #	#	Pg. #	Mfg. #	#	Pg. #
75004911	75004911	169 JS	75005220	75005220	151 JS	75006650	75006650	149 JS, 332 FS	75007268	75007268	153 JS, 335 FS	75009232	75009232	152 JS, 334 FS
75004913	75004913	171 JS	75005230	75005230	151 JS	75006651	75006651	149 JS, 332 FS	75007268	75007268	153 JS, 335 FS	75009234	75009234	152 JS, 334 FS
75004914	75004914	170 JS	75005240	75005240	151 JS	75006655	75006655	151 JS	75007269	75007269	153 JS, 335 FS	75009236	75009236	152 JS, 334 FS
75004914	75004914	170 JS	75005250	75005250	151 JS	75006670	75006670	149 JS, 332 FS	75007270	75007270	153 JS, 335 FS	75009242	75009242	152 JS, 334 FS
75004915	75004915	170 JS	75005317	75005317	151 JS	75006670	75006670	149 JS, 332 FS	75007271	75007271	153 JS, 335 FS	75009244	75009244	152 JS, 334 FS
75004915	75004915	170 JS	75005327	75005327	151 JS	75006674	75006674	149 JS, 332 FS	75007272	75007272	153 JS, 335 FS	75009246	75009246	152 JS, 334 FS
75004916	75004916	170 JS	75005337	75005337	151 JS	75006675	75006675	149 JS, 332 FS	75007272	75007272	153 JS, 335 FS	75009252	75009252	152 JS, 334 FS
75004916	75004916	170 JS	75005347	75005347	151 JS	75007001	75007001	154 JS, 335 FS	75007273	75007273	153 JS, 335 FS	75009254	75009254	152 JS, 334 FS
75004917	75004917	167 JS	75005357	75005357	151 JS	75007001	75007001	154 JS, 335 FS	75007273	75007273	153 JS, 335 FS	75009256	75009256	152 JS, 334 FS
75004918	75004918	166 JS	75005417	75005417	151 JS	75007002	75007002	154 JS, 335 FS	75007274	75007274	153 JS, 335 FS	75009262	75009262	153 JS, 334 FS
75004919	75004919	168 JS	75005427	75005427	151 JS	75007003	75007003	154 JS, 335 FS	75007275	75007275	153 JS, 335 FS	75009262	75009262	153 JS, 334 FS
75004919	75004919	168 JS	75005437	75005437	151 JS	75007004	75007004	154 JS, 335 FS	75007279	75007279	154 JS, 336 FS	75009264	75009264	153 JS, 334 FS
75004921	75004921	170 JS	75005447	75005447	151 JS	75007006	75007006	154 JS, 335 FS	75007280	75007280	154 JS, 336 FS	75009266	75009266	153 JS, 334 FS
75004921	75004921	170 JS	75005457	75005457	151 JS	75007007	75007007	154 JS, 335 FS	75007281	75007281	154 JS, 336 FS	75009267	75009267	153 JS, 334 FS
75004922	75004922	170 JS	75005710	75005710	152 JS, 333 FS	75007008	75007008	154 JS, 335 FS	75007284	75007284	154 JS, 335 FS	75009270	75009270	154 JS, 336 FS
75004923	75004923	167 JS	75005720	75005720	152 JS, 333 FS	75007009	75007009	154 JS, 335 FS	75007501	75007501	155 JS	75009271	75009271	154 JS, 336 FS
75004924	75004924	167 JS	75005720	75005720	152 JS, 333 FS	75007026	75007026	154 JS, 335 FS	75007503	75007503	155 JS	75009272	75009272	154 JS, 336 FS
75004926	75004926	170 JS	75005722	75005722	152 JS, 333 FS	75007027	75007027	154 JS, 335 FS	75007503	75007503	155 JS	75009273	75009273	154 JS, 336 FS
75004927	75004927	170 JS	75005730	75005730	152 JS, 333 FS	75007028	75007028	154 JS, 335 FS	75007505	75007505	155 JS	75009274	75009274	154 JS, 336 FS
75004929	75004929	173 JS	75005730	75005730	152 JS, 333 FS	75007029	75007029	154 JS, 335 FS	75007507	75007507	155 JS	75009275	75009275	154 JS, 336 FS
75004930	75004930	170 JS	75005732	75005732	152 JS, 333 FS	75007035	75007035	154 JS, 335 FS	75007509	75007509	155 JS	75009276	75009276	154 JS, 336 FS
75004931	75004931	170 JS	75005740	75005740	152 JS, 333 FS	75007036	75007036	154 JS, 335 FS	750080310	750080310	151 JS, 333 FS	75009277	75009277	154 JS, 336 FS
75004932	75004932	170 JS	75005740	75005740	152 JS, 333 FS	75007037	75007037	154 JS, 335 FS	75008320	75008320	151 JS, 333 FS	75009278	75009278	154 JS, 336 FS
75004934	75004934	170 JS	75005742	75005742	152 JS, 333 FS	75007064	75007064	155 JS, 336 FS	75008330	75008330	151 JS, 333 FS	75009279	75009279	154 JS, 336 FS
75004935	75004935	170 JS	75005742	75005742	152 JS, 333 FS	75007071	75007071	155 JS, 336 FS	75008340	75008340	151 JS, 333 FS	75009280	75009280	154 JS, 336 FS
75004935	75004935	170 JS	75005750	75005750	152 JS, 333 FS	75007081	75007081	155 JS, 336 FS	75008350	75008350	151 JS, 333 FS	75009281	75009281	154 JS, 336 FS
75004938	75004938	173 JS	75005750	75005750	152 JS, 333 FS	75007082	75007082	155 JS, 336 FS	75008410	75008410	151 JS, 333 FS	75009282	75009282	154 JS, 336 FS
75004940	75004940	170 JS	75005752	75005752	152 JS, 333 FS	75007084	75007084	155 JS, 336 FS	75008420	75008420	151 JS, 333 FS	75009283	75009283	154 JS, 336 FS
75004940	75004940	170 JS	75005798	75005798	150 JS	75007110	75007110	148 JS, 331 FS	75008430	75008430	151 JS, 333 FS	75009284	75009284	154 JS, 336 FS
75004941	75004941	170 JS	75005799	75005799	150 JS	75007120	75007120	148 JS, 331 FS	75008440	75008440	151 JS, 333 FS	75009285	75009285	154 JS, 336 FS
75004941	75004941	170 JS	75005800	75005800	150 JS	75007122	75007122	148 JS, 331 FS	75008450	75008450	151 JS, 333 FS	75009285	75009285	154 JS, 336 FS
75004942	75004942	170 JS	75005822	75005822	152 JS, 333 FS	75007123	75007123	148 JS, 331 FS	75008871	75008871	148 JS	75009346	75009346	153 JS, 334 FS
75004945	75004945	170 JS	75005832	75005832	152 JS, 333 FS	75007125	75007125	148 JS, 331 FS	75008874	75008874	148 JS	75009500	75009500	25 GS, 119 JS
75004946	75004946	170 JS	75005842	75005842	152 JS, 333 FS	75007126	75007126	148 JS, 331 FS	75008880	75008880	147 JS	75009505	75009505	25 GS, 122 JS
75004946	75004946	170 JS	75005852	75005852	152 JS, 333 FS	75007130	75007130	148 JS, 331 FS	75008882	75008882	147 JS	75009506	75009506	122 JS
75004947	75004947	170 JS	75006110	75006110	149 JS, 332 FS	75007130	75007130	148 JS, 331 FS	75008824	75008824	147 JS	75009510	75009510	28 GS, 135 JS
75004949	75004949	177 JS	75006111	75006111	149 JS, 332 FS	75007132	75007132	148 JS, 331 FS	75008825	75008825	147 JS	75009515	75009515	28 GS, 135 JS
75004950	75004950	171 JS	75006120	75006120	149 JS, 332 FS	75007133	75007133	148 JS, 331 FS	75008826	75008826	147 JS	75009520	75009520	26 GS, 128 JS
75004950	75004950	171 JS	75006121	75006121	149 JS, 332 FS	75007135	75007135	148 JS, 331 FS	75008830	75008830	147 JS	75009525	75009525	26 GS, 128 JS
75004950	75004950	171 JS	75006130	75006130	149 JS, 332 FS	75007136	75007136	148 JS, 331 FS	75008831	75008831	147 JS	75009530	75009530	26 GS, 128 JS
75004951	75004951	171 JS	75006131	75006131	149 JS, 332 FS	75007139	75007139	148 JS, 331 FS	75008834	75008834	147 JS	75009535	75009535	26 GS, 128 JS
75004951	75004951	171 JS	75006140	75006140	149 JS, 332 FS	75007139	75007139	148 JS, 331 FS	75008835	75008835	147 JS	75009540	75009540	267 FS
75004952	75004952	171 JS	75006141	75006141	149 JS, 332 FS	75007140	75007140	148 JS, 331 FS	75008836	75008836	147 JS	75009545	75009545	265 FS
75004953	75004953	171 JS	75006150	75006150	149 JS, 332 FS	75007140	75007140	148 JS, 331 FS	75008840	75008840	147 JS	75009550	75009550	265 FS
75004954	75004954	172 JS	75006151	75006151	149 JS, 332 FS	75007142	75007142	148 JS, 331 FS	75008841	75008841	147 JS	75009555	75009555	27 GS, 132 JS
75004954	75004954	172 JS	75006155	75006155	149 JS, 332 FS	75007143	75007143	148 JS, 331 FS	75008844	75008844	147 JS	75009801	75009801	168 JS
75004958	75004958	172 JS	75006160	75006160	149 JS, 332 FS	75007145	75007145	148 JS, 331 FS	75008845	75008845	147 JS	75009801	75009801	168 JS
75004959	75004959	171 JS	75006170	75006170	149 JS, 332 FS	75007146	75007146	148 JS, 331 FS	75008846	75008846	147 JS	75009804	75009804	168 JS
75004960	75004960	167 JS	75006180	75006180	149 JS, 332 FS	75007147	75007147	148 JS, 331 FS	75008850	75008850	147 JS	75009804	75009804	168 JS
75004960	75004960	167 JS	75006190	75006190	149 JS, 332 FS	75007149	75007149	148 JS, 331 FS	75008851	75008851	147 JS	75009805	75009805	168 JS
75004961	75004961	167 JS	75006199	75006199										

2 Dryer Sheets
126 Dryer Carpet
128 Dryer Mat
70 Dryer Mat Handles
53 Dryer Mat Straps
102 Dryer Mat Trimmer
77 Dryer Pins
2 Dusters
129 Dusters, Sponges
148 Dusters, Sponges
150 Dusters, Sponges
151 Extension File
152 Extension File

Vendor Numeric Index

VENDOR NUMERIC INDEX

Table with columns: Mfg. #, #, Pg. #. Multiple columns of data listing manufacturer numbers, internal codes, and page numbers. Includes sub-sections like PROCTER & GAMBLE and RECKITT BENCKISER.

Vendor Numeric Index

Index	
2	Dye Sheets
100	Dye Cartridge
101	Dye Ink
102	Dye Ink Cartridge
103	Dye Ink Pad
104	Dye Ink Pad
105	Dye Ink Pad
106	Dye Ink Pad
107	Dye Ink Pad
108	Dye Ink Pad
109	Dye Ink Pad
110	Dye Ink Pad
111	Dye Ink Pad
112	Dye Ink Pad
113	Dye Ink Pad
114	Dye Ink Pad
115	Dye Ink Pad
116	Dye Ink Pad
117	Dye Ink Pad
118	Dye Ink Pad
119	Dye Ink Pad
120	Dye Ink Pad
121	Dye Ink Pad
122	Dye Ink Pad
123	Dye Ink Pad
124	Dye Ink Pad
125	Dye Ink Pad
126	Dye Ink Pad
127	Dye Ink Pad
128	Dye Ink Pad
129	Dye Ink Pad
130	Dye Ink Pad
131	Dye Ink Pad
132	Dye Ink Pad
133	Dye Ink Pad
134	Dye Ink Pad
135	Dye Ink Pad
136	Dye Ink Pad
137	Dye Ink Pad
138	Dye Ink Pad
139	Dye Ink Pad
140	Dye Ink Pad
141	Dye Ink Pad
142	Dye Ink Pad
143	Dye Ink Pad
144	Dye Ink Pad
145	Dye Ink Pad
146	Dye Ink Pad
147	Dye Ink Pad
148	Dye Ink Pad
149	Dye Ink Pad
150	Dye Ink Pad
151	Dye Ink Pad
152	Dye Ink Pad
153	Dye Ink Pad
154	Dye Ink Pad
155	Dye Ink Pad
156	Dye Ink Pad
157	Dye Ink Pad
158	Dye Ink Pad
159	Dye Ink Pad
160	Dye Ink Pad
161	Dye Ink Pad
162	Dye Ink Pad
163	Dye Ink Pad
164	Dye Ink Pad
165	Dye Ink Pad
166	Dye Ink Pad
167	Dye Ink Pad
168	Dye Ink Pad
169	Dye Ink Pad
170	Dye Ink Pad
171	Dye Ink Pad
172	Dye Ink Pad
173	Dye Ink Pad
174	Dye Ink Pad
175	Dye Ink Pad
176	Dye Ink Pad
177	Dye Ink Pad
178	Dye Ink Pad
179	Dye Ink Pad
180	Dye Ink Pad
181	Dye Ink Pad
182	Dye Ink Pad
183	Dye Ink Pad
184	Dye Ink Pad
185	Dye Ink Pad
186	Dye Ink Pad
187	Dye Ink Pad
188	Dye Ink Pad
189	Dye Ink Pad
190	Dye Ink Pad
191	Dye Ink Pad
192	Dye Ink Pad
193	Dye Ink Pad
194	Dye Ink Pad
195	Dye Ink Pad
196	Dye Ink Pad
197	Dye Ink Pad
198	Dye Ink Pad
199	Dye Ink Pad
200	Dye Ink Pad

Mfg. #	#	Pg. #	Mfg. #	#	Pg. #	Mfg. #	#	Pg. #	Mfg. #	#	Pg. #	Mfg. #	#	Pg. #
76523	58346600	51	12438	18902438	304	RH1648N	61600012	198	2640	177077321	209	354060GRAY	177001111	204
76754	58346754	77	12454	18902454	304	RH1649N	61600010	198	2642	17707736	210	354075	177035481	32
76755	58346755	77	13297	18900212	304	RH17860N	61600013	198	2642	177077361	210	3540BEIG	17700858	204
76938	58346938	74	13300	18900211	304	RH624N	61601624	198	264373	177043061	32	3540BLA	17707985	204
76940	58346940	74	13358	18903358	306	RH633N	61600037	198	2643DBLUE	17702642	205	3540BLA	177079851	204
77500	58340919	56	13408	18900203	306	RH833N	61600833	198	2643GRAY	17707738	205	3540BRN	17707986	204
77136	58347136	69	13486	18903486	304	RP232W	61602323	198	2643GRAY	177077381	205	3540BRN	177079861	204
77137	58340004	69	13493	17303493	304	RUBBERMAID						3540DBLUE	17707432	204
77182	58347182	161	13614	17303614	271	1011	17701012	213	2643RED	177077421	205	3540DBLUE	177004321	204
77335	58347335	117	150312	17301755	323	1025	17707318	213	2643WHT	17707740	205	3540GRAY	17700123	204
77340	58347340	77	2016	14902016	306	1304	17701319	213	2643WHT	177077401	205	3540GRAY	177001231	204
77660	58347660	67	2146	17302250	323	130506	17701308	213	2643YEL	17702643	205	3541BEIG	17700859	204
77869	58347869	77	26301	17302630	280	1305BLA	17701301	213	2643YEL	17702643	205	3541BEIG	17700860	204
77873	58347873	116	26561	17302656	280	1306BLA	17701305	213	2643YEL	177026431	205	3541GRAY	17703541	204
77895	58347895	73	57909MO	17307341	280	1306BLA	17701324	213	264560GRAY	177008611	205	3541GRAY	177035411	204
77914	58348526	76	57919MO	17305791	280	1306G1/2	17701309	213	2645GRAY	17700847	205	3543	17707987	205
77925	58347925	161	611	17300107	325	1314	17701320	213	2646	17703538	210	3546BEIG	17700828	203
77960	58347960	75	611M	17300061	325	1315BLA	17701322	213	264788GRAY	17704788	205	3546GRAY	17707994	203
77961	58347961	75	613	17300613	325	1317BLA	17701323	213	264788RED	17707753	205	3546GRAY	177079941	203
77964	58347964	75	614	17306140	325	1905	177019051	263	2649GRAY	177077561	192	3554GRAY	17703554	204
77965	58347965	75	615	17306150	325	1992	177002911	190	2650	17707758	210	356806	177080001	32
78234	58348234	56	620	17306200	325	1993	177003171	190	265103	17707769	210	3568GRAY	17708002	203
78283	58340028	75	622	17306220	325	1993	177003171	190	2652	17707771	210	356973	177035671	32
78620	58348620	75	624	17306240	325	2005	17702005	172	2654GRAY	17707760	205	356973	17703569	208
78621	58348621	75	624M	17306242	325	2005	177020051	172	2654GRAY	177077601	205	356988BEIG	177080081	203
78664	58348664	74	625	17306250	325	2084300	17702084	188	2655GRAY	17707762	205	356988GRAY	17706988	203
78849	58344906	161	627	17306270	325	2084400	17702084	188	2655GRAY	177077621	205	356988GRAY	17706988	203
79132	58349132	61	632	17300108	325	2523BEIG	17707630	190	265788GRAY	17704790	205	360088	17700017	264
79196	58349196	74	711	17307110	324	2523BLA	17702521	190	265788RED	17705788	205	3620BLA	17703621	204
79553	58349553	75	712	17300712	324	2531BLA	17704149	172	2664BEIG	17707772	204	3620BLA	177036211	204
79782	58349782	75	720	17301720	324	2531BLA	177041491	172	2664BEIG	177077721	204	395873	177039521	32
79830	58349830	76	721	17300721	324	2540BEIG	17700365	200	2664GRAY	17700266	204	3958BEIG	17708054	203
79831	58349831	76	721M	17300720	324	2541BEIG	17702545	200	2664GRAY	177002661	204	3958BEIG	177080541	203
79902	58349902	75	7524	17307524	324	2541BEIG	177025451	200	2672LGRAY	177077861	204	3958GRAY	17703958	203
79904	58349904	75	8630CGC	17300097	15	2541BLA	17700845	200	267360BLA	177001101	205	3958GRAY	177039581	203
79906	58349906	75	8656CGC	17300095	15	2541BLA	17700845	200	267360DBLUE	177026711	32	395973	177059051	32
79907	58349907	75	8657CGC	17300096	15	2541BLA	177008451	200	267360GRAY	177026741	205	3959BEIG	17703959	203
79908	58349908	75	900	17309000	328	2541GRAY	17702546	200	268988BEIG	17702693	204	3959BEIG	177039591	203
80027	58342700	161	904	17300904	328	2543BEIG	17702543	200	268988BEIG	177026931	204	3959GRAY	17703960	203
80088	58348008	69	910	17309100	328	2543BEIG	177025431	200	268988BLA	177026941	204	3964BEIG	17703964	206
80313	58348031	39	914	17309140	328	2543BLA	17702553	200	2689LGRAY	17700210	204	3964DGRN	17703963	206
80689	58340022	52	915	17309150	328	2543BLA	177025531	200	2689LGRAY	177002101	204	3965BEIG	17703968	206
81145	58348114	161	916	17309160	328	2543GRAY	17702554	200	2691	177026951	208	3965DGRN	17703965	206
81146	58341146	161	920	17309200	328	2543GRAY	177025541	200	269288BLU	177029881	208	3965DGRN	17703965	206
81700	58341700	161	930	17309300	328	2544BEIG	17702544	200	269288BLU	177029881	208	396873	17700968	32
94201	58344201	66	937	17309370	328	2544BEIG	177025441	200	269288BRN	177006321	208	396873	17700969	32
94532	58344532	41	FC125X2938	17301757	323	256B73	17702641	32	269288GRN	177026921	208	3970SBLE	17700318	211
95029	58345029	61	RC012F	17308008	271	256B8RN	17702656	206	270388BLU	177027031	32	3973BRN	17703979	211
95524	58345524	61	RC016F	17308011	271	256BOWHT	17702756	206	2791	177027911	32	3975SBLE	17708069	211
95701	58345701	89	RC018F	17308013	271	256LDBLUE	17702058	32	2794	177059071	32	4004ROCK	17704004	211
95717	58345717	89	RC1144	17303144	295	256R73	17700155	207	4091GRAY	177029471	203	4091GRAY	17704091	191
97161	58347161	115	RC1149	17301149	295	256VBRN	17707644	206	295573	177029551	32	4094	17700581	192
97402	58347402	116	RC1150	17301150	295	257088BEIG	17702574	211	2955BEIG	17707836	200	4095BLA	17704095	192
			RC1173	17301173	295	257088BLA	17702573	211	2955BEIG	177078361	200	4096BL		

How to Use This Catalog

• Products are presented in a logical pattern for easy navigation

- **Table of Contents** lists all the product groups
- **Product-Specific Index** sends you directly to its listing in the catalog
- **Vendor Numeric Index** shows where all that manufacturer's products are listed in the book and also shows our codes

Tab Sections make it easy to find product groupings

Headers on every page
Frequent Subheads to keep like products together

Specific products are listed smallest to largest where applicable

Product images are alpha coded for easy identification

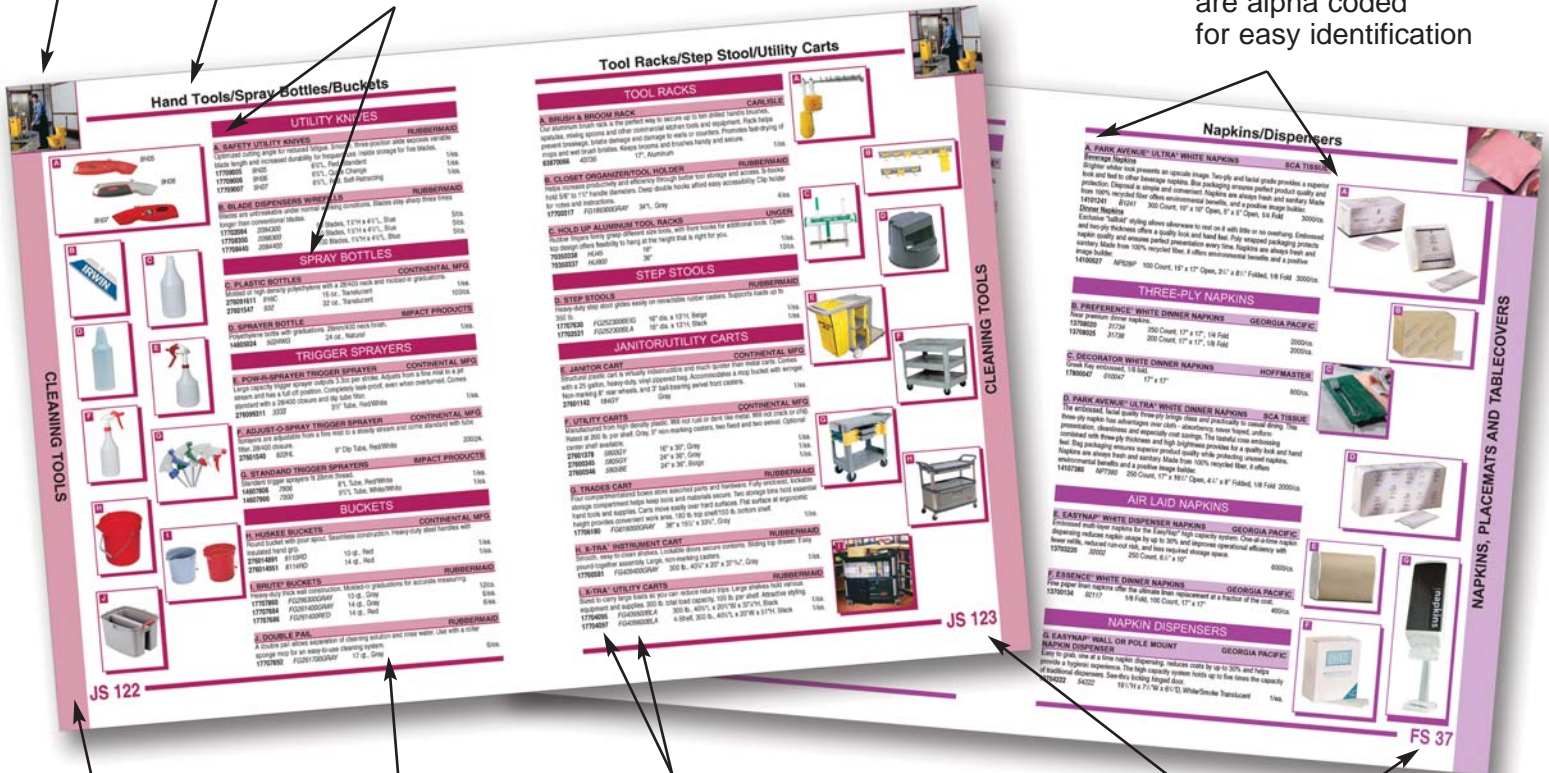

Color-coded sections

Descriptions provide general information, selling points, specific product usage and case packs

Our item numbers are printed in bold
Manufacturer numbers are printed in light italic

Three Modular Divisions
GS Green
JS for Jan/San
FS for Food Service